



**SCHIRTEC®**

**LIGHTNING PROTECTION SYSTEMS  
SURGE PROTECTION DEVICES  
EARTHING MATERIALS**

**2014-2015**



*Created For Your Safety*



**ICMET**



BLITZSCHUTZ & EMV TECHNOLOGIEZENTRUM



Staatliche Versuchsanstalt





## EXTERNAL PROTECTION

### SCHIRTEC E.S.E. LIGHTNING CONDUCTORS

SCHIRTEC E.S.E. Lightning Conductors protect large fields from one point by becoming active with the lightning risk by increasing the atmospheric electric field effect during thunderstorms.

The head of E.S.E. Lightning Conductors is divided into four main parts:

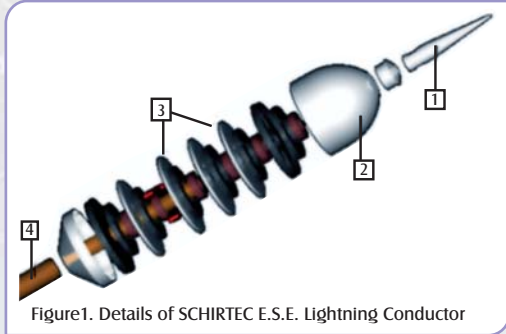

1. Air Terminal
2. Ion Generator
3. Accelerator and Atmospheric Electrodes
4. Grounding Connection Terminal

Figure1. Details of SCHIRTEC E.S.E. Lightning Conductor

The air terminal resists the biggest lightning strikes due to its high quality. The ion generator, induction coil and the protector have a high impedance. The generator is located inside of a special epoxy resin to be protected from the environmental conditions.

The accelerator and atmospheric electrodes are designed in a way that they can be charged with different potentials. The electrodes work as an additional ionization producing resource and as an accelerator.

The different protection capacities of the SCHIRTEC E.S.E. Lightning Conductors are regulated by the number of electrodes and the ion generator's impedance.

The products of SCHIRTEC are in accordance to the new NFC 17-102: 2011 and the UNE 21186: 2011 Standards. The high quality products are made of stainless steel and cause no risk for the environment, which is confirmed by TÜV Austria. The discharge capacity of lightning is confirmed by the laboratories BET Germany and CTI Vienna.

The most important factor of SCHIRTEC E.S.E. Lightning Conductors is the protection radius, which depends on the level calculation and the  $\Delta T$  value, found in the product's test reports.

The level of protection is calculated according to appendix B of the NF C 17-102.

The protection radius is calculated;  $R_p = (h(2D-h) + \Delta L(2D+\Delta L))^{0,5} \quad h \geq 5m \dots \dots \dots \text{Eq.1}$

**h(m):** True height of the Schirtec E.S.E. above the surface to be protected

**D(m):** Standardised striking distance  $D = 20m$  (level I),  $30m$  (level II),  $45m$  (level III) or  $60m$  (level IV)

**$\Delta L$  (m):** Triggering advance  $\Delta T$  measured during efficiency tests acc. to appendix C of the NF C 17-102 standard which allows  $\Delta T$  to be calculated using the formula  $\Delta L = V \cdot \Delta T$ ,  $V = 10^6$  m/s from NF C 17-102.

**A sample calculation for SCHIRTEC-A:**

If you calculate **Level-I** according to appendix B of the NF C 17-102  
**For  $D=20$  m,  $\Delta L=60$  m,  $h=6$  m,**  
**from  $R_p = (h(2D-h) + \Delta L(2D+\Delta L))^{0,5}$  ...Eq.1**  
**Protection radius is  $R_p = 79$  m calculated.**

If you calculate **Level-II** according to appendix B of the NF C 17-102  
**For  $D=30$  m,  $\Delta L=60$  m,  $h=6$  m,**  
**from Eq.1,  $R_p=87$  m calculated.**

If you calculate **Level-III** according to appendix B of the NF C 17-102  
**For  $D=45$  m,  $\Delta L=60$  m,  $h=6$  m,**  
**from Eq.1,  $R_p=97$  m calculated.**

If you calculate **Level-IV** according to appendix B of the NF C 17-102  
**For  $D=60$  m,  $\Delta L=60$  m,  $h=6$  m**  
**from Eq.1,  $R_p=107$  m calculated**

**The Protection Radius For SCHIRTEC E.S.E. Lightning Conductors (According to NF C 17-102)**

Rp (m) h(m) \ Np	SCHIRTEC-AM ( $\Delta T: 15 \mu s$ )				SCHIRTEC-AS ( $\Delta T: 30 \mu s$ )				SCHIRTEC-DAS ( $\Delta T: 45 \mu s$ )				SCHIRTEC-A/DA ( $\Delta T: 60 \mu s$ )			
	I	II	III	IV	I	II	III	IV	I	II	III	IV	I	II	III	IV
2	13	15	18	20	19	22	25	28	25	28	32	36	31	35	39	43
4	25	27	36	41	38	44	51	57	51	57	64	72	63	69	78	85
5	32	37	45	51	48	55	63	71	63	71	81	89	79	86	97	107
6	32	38	46	52	48	55	64	72	63	71	81	90	79	87	97	107
8	33	39	47	54	49	56	65	73	64	72	82	91	79	87	98	108
10	34	41	49	56	49	57	66	75	64	72	83	92	79	88	99	109
20	35	43	55	63	50	59	71	81	65	74	86	97	80	89	102	113
30	35	45	58	69	50	60	73	85	65	75	89	101	80	90	104	116



**SCHIRTEC®**

## E.S.E. SCHIRTEC LIGHTNING CONDUCTORS

					
Model	<b>S-AM</b>	<b>S-AS</b>	<b>S-A</b>	<b>S-DAS*</b>	<b>S-DA*</b>
Protection Radius	15 $\mu$ s	30 $\mu$ s	60 $\mu$ s	45 $\mu$ s	63 $\mu$ s
Tested Protection Radius $\Delta T$ ( $\mu$ s)	17 $\mu$ s	32 $\mu$ s	65 $\mu$ s	47 $\mu$ s	73 $\mu$ s
Size (cm)	48x9	55x12	59x12	66x12	70x12
Weight (kg)	1,2	2,6	2,8	3,8	4,1
Material	Stainless steel				
Standards	NFC 17-102: 2011 and UNE 21186: 2011				

\* PREMIUM Models with second ion generator for additional safety

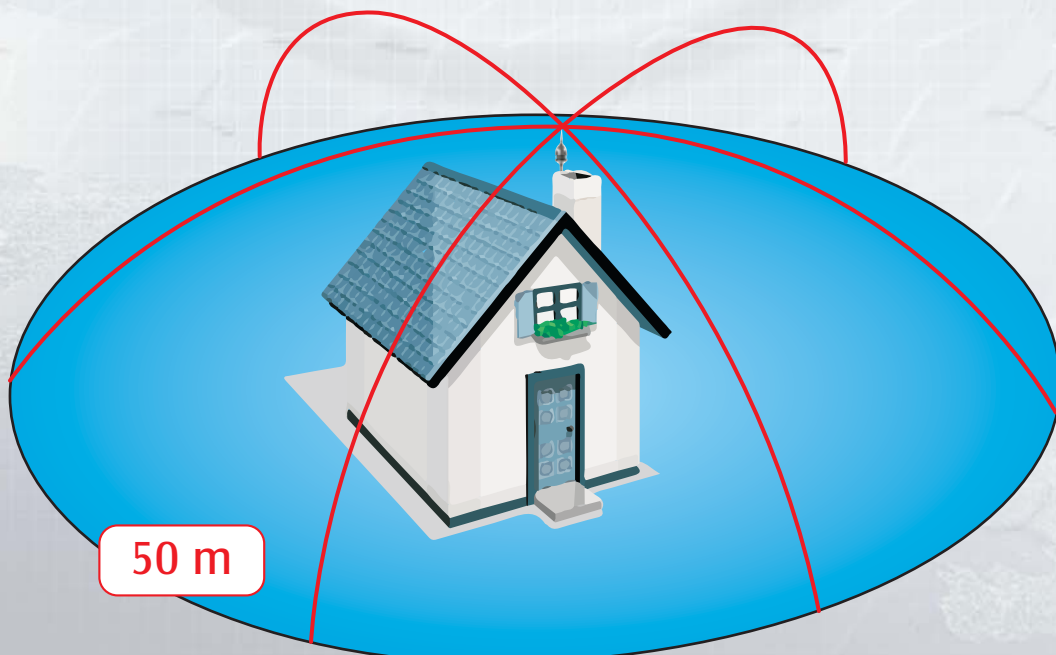



# SCHIRTEC E.S.E. LIGHTNING CONDUCTORS TESTED NFC 17-102 2011 VERSION

**TEST REPORT No. 4397 / 26.09.2013**

**ICMET CRAIOVA**  
RESEARCH & TESTING NATIONAL INSTITUTE FOR ELECTRICAL ENGINEERING  
High Voltage Laboratory and Experimental Competence  
BRI, ENP

3204 Strada No. 13, 20176 Craiova, Romania  
Phone: +40 251 40523, 40486, Fax: +40 251 40485  
www.schirtec.ro, info@schirtec.ro

**CLIENT:** SCHIRTEC AD  
Sponsor: S&S Strada 10, A-1259 Wina, Austria

**MANUFACTURER:** SCHIRTEC AD  
Sponsor: S&S Strada 10, A-1259 Wina, Austria

**3. TESTED PRODUCT:** Early Resonant Evanescent (E.S.E.) Lightning Conductor type SCHIRTEC - A (S-A-S)

**4. REFERENCE STANDARDS:** NFC 17-102:2011, Annex C  
EN62571-2:2011, Annex C

**5. TEST PERFORMANCE:** Determination of the E.S.E. lightning conductor efficiency

**6. TEST DATE:** 04.05.2013

**7. TEST RESULTS:** These are presented in the measurements results.

**8. The report consists of 14 pages.**

**9. The test report is valid in English, except for the annexes in laboratory and report 3, 4 and 6 are valid in the original language.**

**HEAD OF DIVISION:** Eng. PETRU POP  
**HEAD OF LABORATORY:** Eng. ADRIAN POP

1. Based on the information provided, the test report is valid for the test object and the test conditions described in the test report. 2. The test report is not valid for other test objects or test conditions than those described in the test report. 3. The test report is not valid for other test methods than those described in the test report. 4. The test report is not valid for other test standards than those described in the test report. 5. The test report is not valid for other test equipment than those described in the test report. 6. The test report is not valid for other test locations than those described in the test report.

**TEST REPORT No. 4397** page 7

**3. Test on E.S.E. Lightning Conductor type SCHIRTEC-A(S-A-S)**

**3.1. Acceptance date:** 02.07.2013  
**3.2. Test date:** 04.05.2013

**3.3. Atmospheric conditions**

BEFORE TEST	$p = 1013 \text{ hPa}$ $T = 15.8 \text{ }^\circ\text{C}$ $W = 63.7 \%$
MIDDLE OF THE TEST	$p = 1013 \text{ hPa}$ $T = 15.8 \text{ }^\circ\text{C}$ $W = 63.7 \%$
END OF THE TEST	$p = 1013 \text{ hPa}$ $T = 15.8 \text{ }^\circ\text{C}$ $W = 63.7 \%$

**3.4. Results** See annex from page 9

Number of significant impulses: 50  
Average of significant  $T_{50}$ : Break down time obtained from the experimental results is  $T_{50} = 176.7 \text{ ns}$  with a standard deviation from  $\pm 10.7 \%$ .  
By transferring  $T_{50}$  on the reference waveform it was obtained  $T_{ref} = 278.31 \text{ ns}$   
See annex from page 10

Allowing uncertainty for  $\pm 17.5 \%$ .  
The uncertainty level is statistical uncertainty obtained by multiplying the standard uncertainty by the coverage factor  $k = 2$ . The value of measured for which the assigned range of values with probability of 95 %

Early return voltage:  $U_T = T_{ref} - T_{50} = 106.22 - 176.71 \text{ ns} = 70.49 \text{ ns} \pm 12.24 \%$

The tested lightning conductors are E.S.E. type, compliance criteria are established in Annex B table 3 according to NFC 17-102:2011, Annex C, clause C.3.3.3.5  
Type: "E.S.E." (S-A-S)  
- Mass: "E.S.E." (S-A-S) = 0.8 kg  
- Type: "E.S.E." (S-A-S)

Shipping address:  $U_T = T_{ref} - T_{50} = 106.22 - 176.71 \text{ ns} = 70.49 \text{ ns} \pm 12.24 \%$

**TEST REPORT No. 4392 / 26.09.2013**

**ICMET CRAIOVA**  
RESEARCH & TESTING NATIONAL INSTITUTE FOR ELECTRICAL ENGINEERING  
High Voltage Laboratory and Experimental Competence  
BRI, ENP

3204 Strada No. 13, 20176 Craiova, Romania  
Phone: +40 251 40523, 40486, Fax: +40 251 40485  
www.schirtec.ro, info@schirtec.ro

**CLIENT:** SCHIRTEC AD  
Sponsor: S&S Strada 10, A-1259 Wina, Austria

**MANUFACTURER:** SCHIRTEC AD  
Sponsor: S&S Strada 10, A-1259 Wina, Austria

**3. TESTED PRODUCT:** Early Resonant Evanescent (E.S.E.) Lightning Conductor type SCHIRTEC - B(S-B-S)

**4. REFERENCE STANDARDS:** NFC 17-102:2011, Annex C  
EN62571-2:2011, Annex C

**5. TEST PERFORMANCE:** Determination of the E.S.E. lightning conductor efficiency

**6. TEST DATE:** 04.05.2013

**7. TEST RESULTS:** These are presented in the measurements results.

**8. The report consists of 17 pages.**

**9. The test report is valid in English, except for the annexes in laboratory and report 3, 4 and 6 are valid in the original language.**

**HEAD OF DIVISION:** Eng. PETRU POP  
**HEAD OF LABORATORY:** Eng. ADRIAN POP

**TEST REPORT No. 4392** page 7

**3. Test on E.S.E. Lightning Conductor type SCHIRTEC-B(S-B-S)**

**3.1. Acceptance date:** 02.07.2013  
**3.2. Test date:** 04.05.2013

**3.3. Atmospheric conditions**

BEFORE TEST	$p = 1013 \text{ hPa}$ $T = 15.8 \text{ }^\circ\text{C}$ $W = 63.7 \%$
MIDDLE OF THE TEST	$p = 1013 \text{ hPa}$ $T = 15.8 \text{ }^\circ\text{C}$ $W = 63.7 \%$
END OF THE TEST	$p = 1013 \text{ hPa}$ $T = 15.8 \text{ }^\circ\text{C}$ $W = 63.7 \%$

**3.4. Results** See annex from page 9

Number of significant impulses: 50  
Average of significant  $T_{50}$ : Break down time obtained from the experimental results is  $T_{50} = 176.7 \text{ ns}$  with a standard deviation from  $\pm 10.7 \%$ .  
By transferring  $T_{50}$  on the reference waveform it was obtained  $T_{ref} = 278.27 \text{ ns}$   
See annex from page 10

Allowing uncertainty for  $\pm 17.5 \%$ .  
The uncertainty level is statistical uncertainty obtained by multiplying the standard uncertainty by the coverage factor  $k = 2$ . The value of measured for which the assigned range of values with probability of 95 %

Shipping address:  $U_T = T_{ref} - T_{50} = 106.22 - 176.71 \text{ ns} = 70.49 \text{ ns} \pm 12.24 \%$

The tested lightning conductors are E.S.E. type, compliance criteria are established in Annex B table 3 according to NFC 17-102:2011, Annex C, clause C.3.3.3.5  
Type: "E.S.E." (S-B-S) = 0.8 kg  
- Mass: "E.S.E." (S-B-S) = 0.8 kg  
- Type: "E.S.E." (S-B-S)

Shipping address:  $U_T = T_{ref} - T_{50} = 106.22 - 176.71 \text{ ns} = 70.49 \text{ ns} \pm 12.24 \%$

**TEST REPORT No. 4367 / 10.01.2013**

**ICMET CRAIOVA**  
RESEARCH & TESTING NATIONAL INSTITUTE FOR ELECTRICAL ENGINEERING  
High Voltage Laboratory and Experimental Competence  
BRI, ENP

3204 Strada No. 13, 20176 Craiova, Romania  
Phone: +40 251 40523, 40486, Fax: +40 251 40485  
www.schirtec.ro, info@schirtec.ro

**CLIENT:** SCHIRTEC AD  
Sponsor: S&S Strada 10, A-1259 Wina, Austria

**MANUFACTURER:** SCHIRTEC AD  
Sponsor: S&S Strada 10, A-1259 Wina, Austria

**3. TESTED PRODUCT:** Early Resonant Evanescent (E.S.E.) Lightning Conductor type SCHIRTEC - A (S-A-S)

**4. REFERENCE STANDARDS:** NFC 17-102:2011, Annex C  
EN62571-2:2011, Annex C

**5. TEST PERFORMANCE:** Determination of the relative efficiency of the E.S.E. lightning conductor

**6. TEST DATE:** 04.05.2013

**7. TEST RESULTS:** These are presented in the measurements results.

**8. The report consists of 17 pages.**

**9. The test report is valid in English, except for the annexes in laboratory and report 3, 4 and 6 are valid in the original language.**

**HEAD OF DIVISION:** Eng. PETRU POP  
**HEAD OF LABORATORY:** Eng. ADRIAN POP

**TEST REPORT No. 4367** page 7

**3. Test on E.S.E. type SCHIRTEC - A**

**3.1. Acceptance date:** 07.01.2013  
**3.2. Test date:** 04.05.2013

**3.3. Atmospheric conditions**

BEFORE TEST	$p = 1013 \text{ hPa}$ $T = 15.8 \text{ }^\circ\text{C}$ $W = 63.7 \%$
AFTER TEST	$p = 1013 \text{ hPa}$ $T = 15.8 \text{ }^\circ\text{C}$ $W = 63.7 \%$

**3.4. Results** See annex from page 9

Number of significant impulses: 100  
Average of significant  $T_{50}$ :  
calculated from the experimental tests  $T_{50} = 207 \text{ ns}$  with a standard deviation from  $\pm 10.7 \%$ .  
calculated on the reference waveform:  $T_{ref} = 278.26 \text{ ns}$   
See annex from page 10

Allowing uncertainty for  $\pm 17.5 \%$ .  
The uncertainty level is statistical uncertainty obtained by multiplying the standard uncertainty by the coverage factor  $k = 2$ . The value of measured for which the assigned range of values with probability of 95 %

Shipping address:  $U_T = T_{ref} - T_{50} = 106.22 - 176.71 \text{ ns} = 70.49 \text{ ns} \pm 12.24 \%$

**TEST REPORT No. 4355 / 26.09.2013**

**ICMET CRAIOVA**  
RESEARCH & TESTING NATIONAL INSTITUTE FOR ELECTRICAL ENGINEERING  
High Voltage Laboratory and Experimental Competence  
BRI, ENP

3204 Strada No. 13, 20176 Craiova, Romania  
Phone: +40 251 40523, 40486, Fax: +40 251 40485  
www.schirtec.ro, info@schirtec.ro

**CLIENT:** SCHIRTEC AD  
Sponsor: S&S Strada 10, A-1259 Wina, Austria

**MANUFACTURER:** SCHIRTEC AD  
Sponsor: S&S Strada 10, A-1259 Wina, Austria

**3. TESTED PRODUCT:** Early Resonant Evanescent (E.S.E.) Lightning Conductor type SCHIRTEC - B(S-B-S)

**4. REFERENCE STANDARDS:** NFC 17-102:2011, Annex C  
EN62571-2:2011, Annex C

**5. TEST PERFORMANCE:** Determination of the E.S.E. lightning conductor efficiency

**6. TEST DATE:** 04.05.2013

**7. TEST RESULTS:** These are presented in the measurements results.

**8. The report consists of 14 pages.**

**9. The test report is valid in English, except for the annexes in laboratory and report 3, 4 and 6 are valid in the original language.**

**HEAD OF DIVISION:** Eng. PETRU POP  
**HEAD OF LABORATORY:** Eng. ADRIAN POP

**TEST REPORT No. 4355** page 7

**3. Test on E.S.E. Lightning Conductor type SCHIRTEC-B(S-B-S)**

**3.1. Acceptance date:** 02.07.2013  
**3.2. Test date:** 04.05.2013

**3.3. Atmospheric conditions**

BEFORE TEST	$p = 1013 \text{ hPa}$ $T = 15.8 \text{ }^\circ\text{C}$ $W = 63.7 \%$
MIDDLE OF THE TEST	$p = 1013 \text{ hPa}$ $T = 15.8 \text{ }^\circ\text{C}$ $W = 63.7 \%$
END OF THE TEST	$p = 1013 \text{ hPa}$ $T = 15.8 \text{ }^\circ\text{C}$ $W = 63.7 \%$

**3.4. Results** See annex from page 9

Number of significant impulses: 50  
Average of significant  $T_{50}$ : Break down time obtained from the experimental results is  $T_{50} = 176.7 \text{ ns}$  with a standard deviation from  $\pm 10.7 \%$ .  
By transferring  $T_{50}$  on the reference waveform it was obtained  $T_{ref} = 278.47 \text{ ns}$   
See annex from page 10

Allowing uncertainty for  $\pm 17.5 \%$ .  
The uncertainty level is statistical uncertainty obtained by multiplying the standard uncertainty by the coverage factor  $k = 2$ . The value of measured for which the assigned range of values with probability of 95 %

Shipping address:  $U_T = T_{ref} - T_{50} = 106.22 - 176.71 \text{ ns} = 70.49 \text{ ns} \pm 12.24 \%$

The tested lightning conductors are E.S.E. type, compliance criteria are established in Annex B table 3 according to NFC 17-102:2011, Annex C, clause C.3.3.3.5  
Type: "E.S.E." (S-B-S) = 0.8 kg  
- Mass: "E.S.E." (S-B-S) = 0.8 kg  
- Type: "E.S.E." (S-B-S)

Shipping address:  $U_T = T_{ref} - T_{50} = 106.22 - 176.71 \text{ ns} = 70.49 \text{ ns} \pm 12.24 \%$

**TEST REPORT No. 4343 / 09.01.2013**

**ICMET CRAIOVA**  
RESEARCH & TESTING NATIONAL INSTITUTE FOR ELECTRICAL ENGINEERING  
High Voltage Laboratory and Experimental Competence  
BRI, ENP

3204 Strada No. 13, 20176 Craiova, Romania  
Phone: +40 251 40523, 40486, Fax: +40 251 40485  
www.schirtec.ro, info@schirtec.ro

**CLIENT:** SCHIRTEC AD  
Sponsor: S&S Strada 10, A-1259 Wina, Austria

**MANUFACTURER:** SCHIRTEC AD  
Sponsor: S&S Strada 10, A-1259 Wina, Austria

**3. TESTED PRODUCT:** Early Resonant Evanescent (E.S.E.) Lightning Conductor type SCHIRTEC - BA (S - BA)

**4. REFERENCE STANDARDS:** NFC 17-102:2011, Annex C  
EN62571-2:2011, Annex C

**5. TEST PERFORMANCE:** Determination of the relative efficiency of the E.S.E. lightning conductor

**6. TEST DATE:** 04.05.2013

**7. TEST RESULTS:** These are presented in the measurements results.

**8. The report consists of 17 pages.**

**9. The test report is valid in English, except for the annexes in laboratory and report 3, 4 and 6 are valid in the original language.**

**HEAD OF DIVISION:** Eng. PETRU POP  
**HEAD OF LABORATORY:** Eng. ADRIAN POP

**TEST REPORT No. 4343** page 7

**3. Test on E.S.E. type SCHIRTEC - BA**

**3.1. Acceptance date:** 07.01.2013  
**3.2. Test date:** 04.05.2013

**3.3. Atmospheric conditions**

BEFORE TEST	$p = 1013 \text{ hPa}$ $T = 15.8 \text{ }^\circ\text{C}$ $W = 63.7 \%$
AFTER TEST	$p = 1013 \text{ hPa}$ $T = 15.8 \text{ }^\circ\text{C}$ $W = 63.7 \%$

**3.4. Results** See annex from page 9

Number of significant impulses: 100  
Average of significant  $T_{50}$ :  
calculated from the experimental tests  $T_{50} = 207 \text{ ns}$  with a standard deviation from  $\pm 10.7 \%$ .  
calculated on the reference waveform:  $T_{ref} = 278.26 \text{ ns}$   
See annex from page 10

Allowing uncertainty for  $\pm 17.5 \%$ .  
The uncertainty level is statistical uncertainty obtained by multiplying the standard uncertainty by the coverage factor  $k = 2$ . The value of measured for which the assigned range of values with probability of 95 %

Shipping address:  $U_T = T_{ref} - T_{50} = 106.22 - 176.71 \text{ ns} = 70.49 \text{ ns} \pm 12.24 \%$



SCHIRTEC®

# SCHIRTEC CERTIFICATES & TEST REPORTS

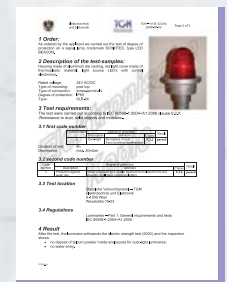
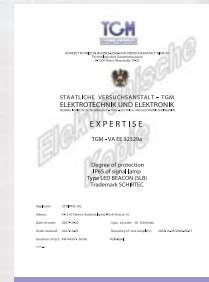
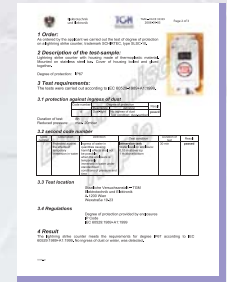
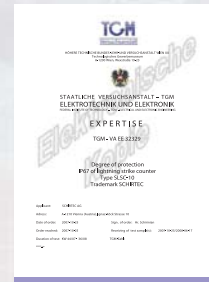



**SCHIRTEC®**

## SOLAR TESTER SRC-1T

All SCHIRTEC E.S.E. Lightning Conductors can be tested any time by utilizing the respective tester. The Tester indicates OK (green LED) or FAULT (red LED). There are two different types of testers available.

	Name	Description	Dimension (cm)
	SA-1T	Tester for E.S.E.	6x9,5x3x8

### 1. SRC-1T

The solar tester works remotely. The testing device stores energy to operate for 24 hours by an exposition of 5-7 hours of sun light daily.

### 2. Installation Manual

1. The Testing Device is installed at a 45 degree angle to the pole facing south.
2. The Testing Device is connected through a cable with the E.S.E. Lightning Conductor.
3. The Testing Device has to be switched ON.
4. A test has to be performed  
(See Chapter 3. How to perform a test?)

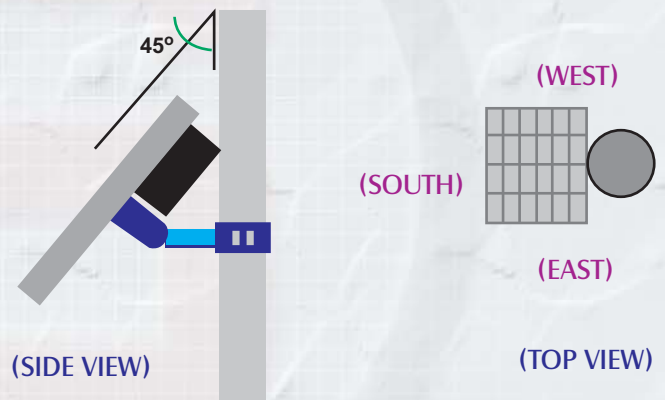

In order to perform a test of the functionality of any SCHIRTEC E.S.E. Lightning Conductor you have to:

- 1) Press the red TEST button for 2 - 3 seconds on the Remote Controller.
- 2) The RX/TX LED lights up in red.
- 3) After releasing the button the Testing Device, which is connected to the SCHIRTEC E.S.E. Lightning Conductor, performs the test.
- 4) After a few seconds the test result will be transmitted via radio frequency to the



Remote Controller:

When the green OK LED lights up and starts blinking; the E.S.E. Lightning Conductor is fully functional.

When the red FAULT LED lights up and starts blinking; the E.S.E. Lightning Conductor is not functional and has to be controlled immediately.

Please note that the Testing Device stores energy to operate for 24 hours taking into consideration that it is exposed to 5-7 hours of sun light daily.



**SCHIRTEC®**

## Exothermic Welding SCHIRTEC



Exothermic welding is a process to join materials permanently with the conductors. Exothermic welding is usually used for welding copper conductors but it is suitable for a wide range of metals.

### Product Packaging

SCHIRTEC Exothermic Welding Powder is available in cartridges with the following content:

- 65 g
- 90 g
- 115 g
- 150 g
- 200 g
- 250 g



The lack of an external heat source and the benefit of joining materials permanently within seconds are one of the advantages of Exothermic Welding. The Exothermic Welding has an excellent corrosion resistance and does not suffer from increased electrical resistance over the lifetime of the installation.

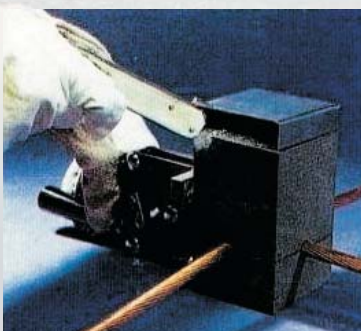



**SCHIRTEC®**

## SA-1T (SCHIRTEC LIGHTNING CONDUCTOR TESTER)



The SCHIRTEC Lightning Conductors can be checked by this Tester every time. The Tester will indicate OK or FAULT with the help of red or green LED.

Ref.No:	Description	Dimension (cm)
SA-1T	SCHIRTEC Tester	6x9,5x3,8

## SLSC-10 (SCHIRTEC LIGHTNING STRIKE COUNTER)



Ref.No:	Description
SLSC-10	SCHIRTEC Lightning Strike Counter

### Description

The Lightning Strikes will be detected and recorded by the SLSC-10. This device can also show the intact operation of the Lightning System.

### Why Should We Use a Lightning Counter?

By using an inductive record, the counter is able accurately to count all lightning events for a later reference.

### Operating Principle

SLSC-10 works with an inductive effect of the lightning strike current. The events are monitored by a mechanical counter display. The counter includes a high frequency transformer.

### Applications and Descriptions

- ⊗ Currents detected from 2 to 100 kA
- ⊗ Nonresetable
- ⊗ Mechanical Counter with 6 digits
- ⊗ Easy mountable
- ⊗ Testable with 9V Battery
- ⊗ Does not require any external power supply
- ⊗ Produced according to IP 67 (certified by TGM Laboratory)
- ⊗ Serial Counter
- ⊗ Dimensions: 11,3x7x4,8 cm

## VARIOUS LIGHTNING PROTECTION ACCESSORIES & EARTHING MATERIALS







### SLB (SCHIRTEC LED BEACON)



#### Properties,

- Ⓢ Special designed red glass cover.
- Ⓢ Aluminium frame.
- Ⓢ Anti-static protection covered circuit.
- Ⓢ Produced according to IP 65 (certified by TGM Laboratory)

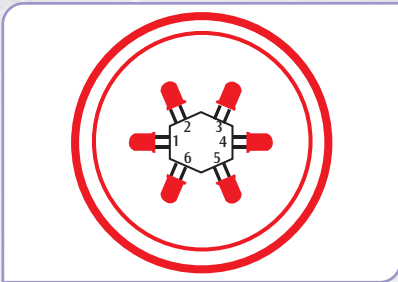

The SCHIRTEC LED BEACON is covered by a red coloured glass and especially manufactured to show a maximum light distribution.

The SCHIRTEC LED BEACON's frame is manufactured by an injection aluminium technology. Upon it, a special kit is mounted in order to facilitate the montage.

For the security purpose, the red glass cover is connected with a slim steel wire (minimum 30 cm) to the aluminium frame firmly.

There is a microprocessor in the electronic circuit of this device which enables us to program the flashing periods.

As remarked in the above figure, there are 6 sets of LED placed in the device hexagonally. Each set consists of 8 pieces of LED totalled to 48 (6X8) pieces of LED. With the help of them, an efficient light distribution is possible for 360 degrees.

The inside micro controller checks all the LEDs permanently and tries to find out any failure. If any failure is located, the error LED should be lighted and the failure contact outputs will be activated.

#### Characteristic of LED ;

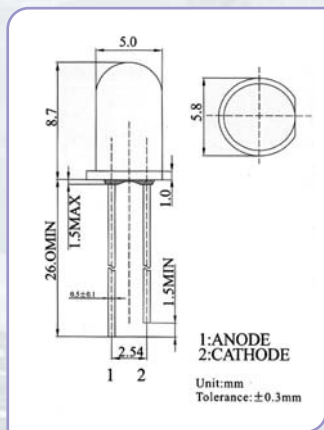

Directive Characteristics (Ta=25°C)

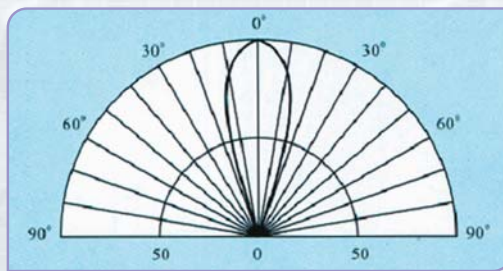

Relative Luminous Intensity (The view of 30 degrees)

This data shows some typical values.

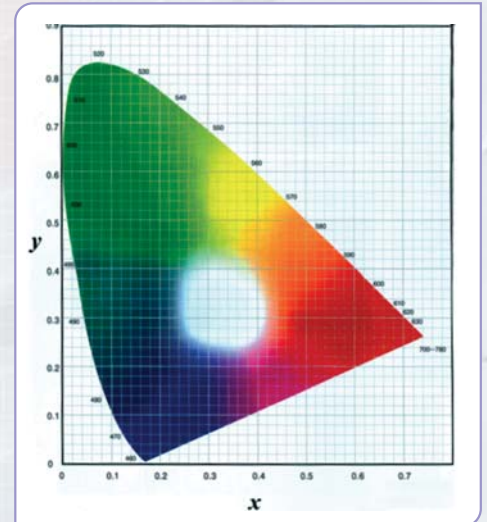

SCHIRTEC LED BEACON			
	SLB-24	SLB-48	SLB-220
Power Supply	24 V AC/ V DC	36-72 V AC/ V DC	220 V AC
Power Consumption		max. 3 W	
Luminescence (typical)		32 cd	
Luminescence (maximum)		46 cd	
Height & Diameter		206&135 mm	
Operating Temperature (°C)		- 40 to +85°C	
Weight		1,5 kg	



SCHIRTEC®

## E.S.E. LIGHTNING CONDUCTORS & PRODUCTS

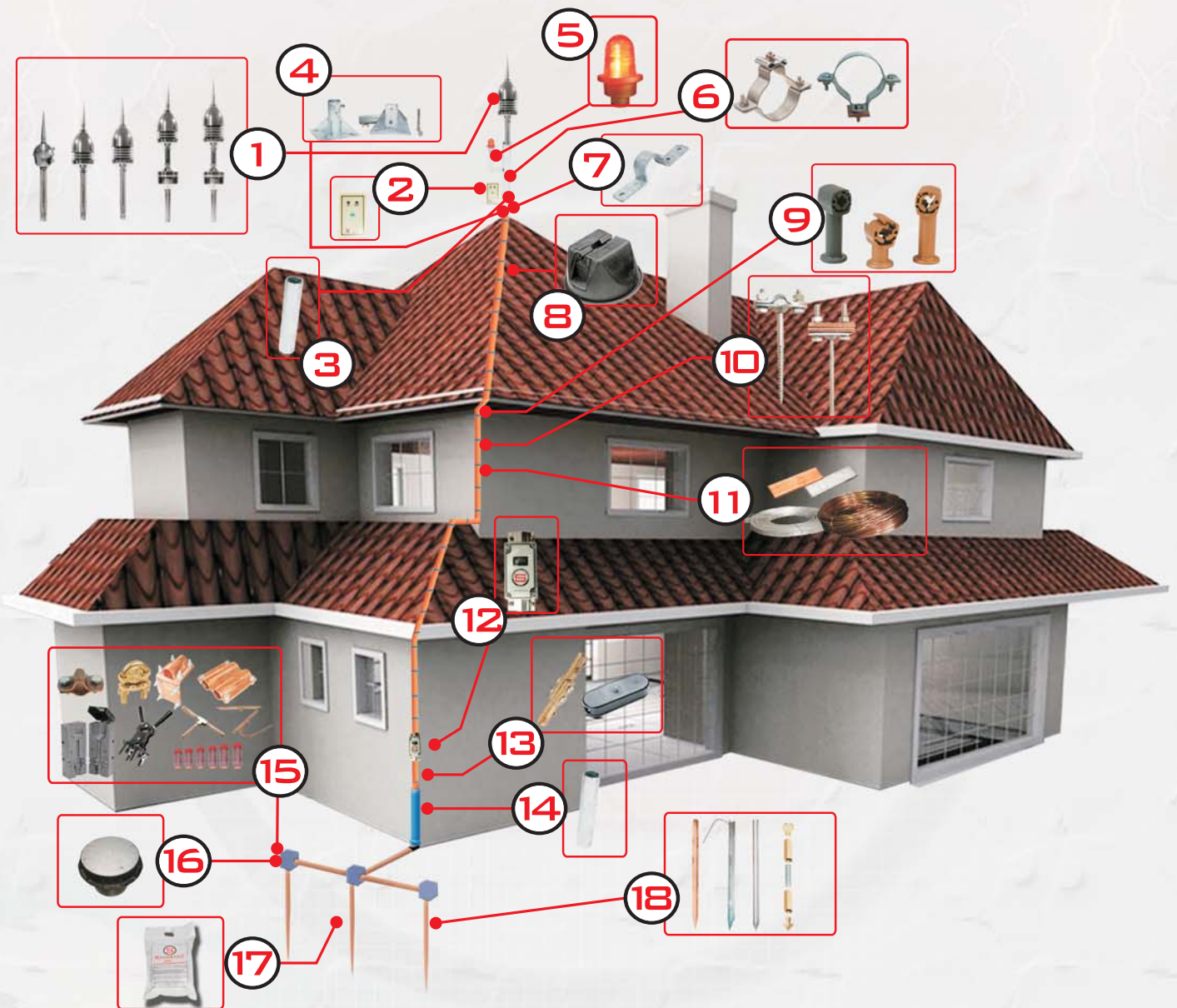

- |  |  |
|--|--|
| ① E.S.E. Lightning Conductors              | ⑩ Wall Holders                               |
| ② E.S.E. Lightning Conductors Tester       | ⑪ Down Conductors                            |
| ③ Galvanized Mast                          | ⑫ Lightning Strike Counter                   |
| ④ Mast Base                                | ⑬ Test Clamps                                |
| ⑤ SCHIRTEC LED Beacon                      | ⑭ Protection Pipe                            |
| ⑥ Mast Clamp                               | ⑮ Earthing Rod Clamps and Exothermic Welding |
| ⑦ Mast Clip                                | ⑯ Plastic, Concrete Inspection Pits          |
| ⑧ Plastic Holders for Isolated Floor/Roofs | ⑰ SCHIRTEC Earthing Enhancement Material     |
| ⑨ Plastic Holders for Isolated Walls       | ⑱ Earthing Rods                              |



SCHIRTEC®

## INTERNAL PROTECTION SURGE PROTECTION DEVICES

### POWER SUPPLY SYSTEMS LIGHTNING ARRESTER CLASS I



- S45 = Encapsulated power spark gap  $I_{imp} = 60\text{ kA (L/N)}$ ,  $U_N = 230\text{ V/50Hz}$ ,  $I_{max} = 100\text{ kA}$ ,  $U_p \leq 2,5\text{ kV}$
- S50-50 = Encapsulated power spark gap  $I_{imp} = 50\text{ kA(L/N)}$ ,  $U_N = 230\text{ V/50Hz}$ ,  $I_{max} = 110\text{ kA}$ ,  $U_p \leq 1,3\text{ kV}$
- S55 = Encapsulated power spark gap  $I_{imp} = 60\text{ kA (L/N)}$ ,  $U_N = 230\text{ V/50Hz}$ ,  $I_{max} = 100\text{ kA}$ ,  $U_p \leq 4\text{ kV}$
- S50-3 = Encapsulated power spark gap  $I_{imp} = 50\text{ kA (L/N)}$ ,  $U_N = 230\text{ V/50Hz}$ ,  $I_{max} = 110\text{ kA}$ ,  $U_p \leq 1,3\text{ kV}$
- S100 = Encapsulated power spark gap  $I_{imp} = 120\text{ kA (N/PE)}$ ,  $U_c = 255\text{ V/50Hz}$ ,  $I_{max} = 160\text{ kA}$ ,  $U_p \leq 2\text{ kV}$
- SB 120 = Lightning arrester class I.  $85\text{ kA (8/20)}$ ,  $U_N = 120\text{ V}$ ,  $I_{max} = 100\text{ kA}$ ,  $U_p \leq 950\text{ V}$
- SB 230 = Lightning arrester class I.  $85\text{ kA (8/20)}$ ,  $U_N = 230\text{ V}$ ,  $I_{max} = 100\text{ kA}$ ,  $U_p \leq 1000\text{ V}$
- SB 400 = Lightning arrester class I.  $85\text{ kA (8/20)}$ ,  $U_N = 400\text{ V}$ ,  $I_{max} = 100\text{ kA}$ ,  $U_p \leq 1600\text{ V}$
- SB 500 = Lightning arrester class I.  $85\text{ kA (8/20)}$ ,  $U_N = 500\text{ V}$ ,  $I_{max} = 100\text{ kA}$ ,  $U_p \leq 2100\text{ V}$
- SB 120S = Lightning arrester class I.  $85\text{ kA (8/20) + dist.sig.}$ ,  $U_N = 120\text{ V}$ ,  $I_{max} = 100\text{ kA}$ ,  $U_p \leq 950\text{ V}$
- SB 230S = Lightning arrester class I.  $85\text{ kA (8/20) + dist.sig.}$ ,  $U_N = 230\text{ V}$ ,  $I_{max} = 100\text{ kA}$ ,  $U_p \leq 1000\text{ V}$
- SB 400S = Lightning arrester class I.  $85\text{ kA (8/20) + dist.sig.}$ ,  $U_N = 400\text{ V}$ ,  $I_{max} = 100\text{ kA}$ ,  $U_p \leq 1600\text{ V}$
- SB 500S = Lightning arrester class I.  $85\text{ kA (8/20) + dist.sig.}$ ,  $U_N = 500\text{ V}$ ,  $I_{max} = 100\text{ kA}$ ,  $U_p \leq 2100\text{ V}$
- SBT 120 = Lightning arrester class I.  $80\text{ kA (8/20)}$ ,  $U_N = 120\text{ V}$ ,  $I_{max} = 80\text{ kA}$ ,  $U_p \leq 1\text{ kV}$
- SBT 230 = Lightning arrester class I.  $80\text{ kA (8/20)}$ ,  $U_N = 230\text{ V}$ ,  $I_{max} = 80\text{ kA}$ ,  $U_p \leq 2\text{ kV}$
- SBT 400 = Lightning arrester class I.  $80\text{ kA (8/20)}$ ,  $U_N = 400\text{ V}$ ,  $I_{max} = 80\text{ kA}$ ,  $U_p \leq 2\text{ kV}$
- SBT 120S = Lightning arrester class I.  $80\text{ kA (8/20) + dist.sig.}$ ,  $U_N = 120\text{ V}$ ,  $I_{max} = 80\text{ kA}$ ,  $U_p \leq 1\text{ kV}$
- SBT 230S = Lightning arrester class I.  $80\text{ kA (8/20) + dist.sig.}$ ,  $U_N = 230\text{ V}$ ,  $I_{max} = 80\text{ kA}$ ,  $U_p \leq 2\text{ kV}$
- SBT 400S = Lightning arrester class I.  $80\text{ kA (8/20) + dist.sig.}$ ,  $U_N = 400\text{ V}$ ,  $I_{max} = 80\text{ kA}$ ,  $U_p \leq 2\text{ kV}$
- SBN-80 = Encapsulated Gas Discharge Tube  $80\text{ kA}$ ,  $U_c = 255\text{ V/50 Hz}$ ,  $I_{max} = 120\text{ kA}$ ,  $U_p \leq 1,3\text{ kV}$
- SBN-100 = Encapsulated Gas Discharge Tube  $100\text{ kA}$ ,  $U_c = 255\text{ V/50Hz}$ ,  $I_{max} = 150\text{ kA}$ ,  $U_p \leq 1,5\text{ kV}$
- SZ110 = Encapsulated power spark gap  $I_{imp} = 110\text{ kA (L/N)}$ ,  $U_N = 230\text{ V AC}$ ,  $U_p \leq 2,5\text{ kV}$
- SZ110/500 = Encapsulated power spark gap  $I_{imp} = 110\text{ kA (L/N)}$ ,  $U_N = 400\text{ V AC}$ ,  $U_p \leq 2,5\text{ kV}$
- SJK110 = Encapsulated power spark gap  $I_{imp} = 110\text{ kA (N/PE)}$ ,  $U_c = 255\text{ V AC}$ ,  $I_{max} = 150\text{ kA}$ ,  $U_p \leq 2\text{ kV}$  □



- SBM7-75 = Lightning arrester class I  $I_{imp} = 7\text{ kA (10/350)}$ ,  $U_c = 75\text{ V AC}$ ,  $I_{max} = 50\text{ kA}$ ,  $U_p < 350\text{ V}$
- SBM7-75S = Lightning arrester class I  $I_{imp} = 7\text{ kA (10/350) dist. sig.}$ ,  $U_c = 75\text{ V AC}$ ,  $I_{max} = 50\text{ kA}$ ,  $U_p < 350\text{ V}$
- SBM7-150 = Lightning arrester class I  $I_{imp} = 7\text{ kA (10/350)}$ ,  $U_c = 150\text{ V AC}$ ,  $I_{max} = 50\text{ kA}$ ,  $U_p < 950\text{ V}$
- SBM7-150S = Lightning arrester class I  $I_{imp} = 7\text{ kA (10/350) dist. sig.}$ ,  $U_c = 150\text{ V AC}$ ,  $I_{max} = 50\text{ kA}$ ,  $U_p < 950\text{ V}$
- SBM7-275 = Lightning arrester class I  $I_{imp} = 7\text{ kA (10/350)}$ ,  $U_c = 275\text{ V AC}$ ,  $I_{max} = 50\text{ kA}$ ,  $U_p < 1,2\text{ kV}$
- SBM7-275S = Lightning arrester class I  $I_{imp} = 7\text{ kA (10/350) dist. sig.}$ ,  $U_c = 275\text{ V AC}$ ,  $I_{max} = 50\text{ kA}$ ,  $U_p < 1,2\text{ kV}$
- SBM7-320 = Lightning arrester class I  $I_{imp} = 7\text{ kA (10/350)}$ ,  $U_c = 320\text{ V AC}$ ,  $I_{max} = 50\text{ kA}$ ,  $U_p < 1,3\text{ kV}$
- SBM7-320S = Lightning arrester class I  $I_{imp} = 7\text{ kA (10/350) dist. sig.}$ ,  $U_c = 320\text{ V AC}$ ,  $I_{max} = 50\text{ kA}$ ,  $U_p < 1,3\text{ kV}$



- SBM7-385 = Lightning arrester class I  $I_{imp} = 7 \text{ kA (10/350)}$   $U_c = 385 \text{ V AC}$   $I_{max} = 50 \text{ kA}$   $U_p < 1,5 \text{ kV}$
- SBM7-385S = Lightning arrester class I  $I_{imp} = 7 \text{ kA (10/350)}$  dist. sig.  $U_c = 385 \text{ V AC}$   $I_{max} = 50 \text{ kA}$   $U_p < 1,5 \text{ kV}$
- SBM7-440 = Lightning arrester class I  $I_{imp} = 7 \text{ kA (10/350)}$   $U_c = 440 \text{ V AC}$   $I_{max} = 50 \text{ kA}$   $U_p < 1,7 \text{ kV}$
- SBM7-440S = Lightning arrester class I  $I_{imp} = 7 \text{ kA (10/350)}$  dist. sig.  $U_c = 440 \text{ V AC}$   $I_{max} = 50 \text{ kA}$   $U_p < 1,7 \text{ kV}$
- SBM12,5-275 = Lightning arrester class I  $I_{imp} = 12,5 \text{ kA (10/350)}$   $U_c = 275 \text{ V AC}$   $I_{max} = 100 \text{ kA}$   $U_p < 1,2 \text{ kV}$
- SBM12,5-275S = Lightning arrester class I  $I_{imp} = 12,5 \text{ kA (10/350)}$  dist. sig.  $U_c = 275 \text{ V AC}$   $I_{max} = 100 \text{ kA}$   $U_p < 1,2 \text{ kV}$
- SBM12,5-320 = Lightning arrester class I  $I_{imp} = 12,5 \text{ kA (10/350)}$   $U_c = 320 \text{ V AC}$   $I_{max} = 100 \text{ kA}$   $U_p < 1,3 \text{ kV}$
- SBM12,5-320S = Lightning arrester class I  $I_{imp} = 12,5 \text{ kA (10/350)}$  dist. sig.  $U_c = 320 \text{ V AC}$   $I_{max} = 100 \text{ kA}$   $U_p < 1,3 \text{ kV}$
- SBM12,5-385 = Lightning arrester class I  $I_{imp} = 12,5 \text{ kA (10/350)}$   $U_c = 385 \text{ V AC}$   $I_{max} = 100 \text{ kA}$   $U_p < 1,5 \text{ kV}$
- SBM12,5-385S = Lightning arrester class I  $I_{imp} = 12,5 \text{ kA (10/350)}$  dist. sig.  $U_c = 385 \text{ V AC}$   $I_{max} = 100 \text{ kA}$   $U_p < 1,5 \text{ kV}$
- SBM12,5-440 = Lightning arrester class I  $I_{imp} = 12,5 \text{ kA (10/350)}$   $U_c = 440 \text{ V AC}$   $I_{max} = 100 \text{ kA}$   $U_p < 1,6 \text{ kV}$
- SBM12,5-440S = Lightning arrester class I  $I_{imp} = 12,5 \text{ kA (10/350)}$  dist. sig.  $U_c = 440 \text{ V AC}$   $I_{max} = 100 \text{ kA}$   $U_p < 1,6 \text{ kV}$
- SBN25 = Encapsulated Gas Discharge Tube 25 kA  $U_c = 255 \text{ V AC}$   $I_{max} = 50 \text{ kA}$   $U_p < 1,3 \text{ kV}$
- SBN25P = Encapsulated Gas Discharge Tube 25 kA  $U_c = 255 \text{ V AC}$   $I_{max} = 50 \text{ kA}$   $U_p < 1,3 \text{ kV}$

### POWER SUPPLY SYSTEMS LIGHTNING ARRESTER CLASS I+II



- SSPC12,5 = 1 Pole Lightning arrester for TNC 12,5 kA (10/350)
- SSPC12,5S = 1 Pole Lightning arrester for TNC 12,5 kA (10/350) + dist.sig.
- SSPC12,5/1+1 = 1 Pole Lightning arrester for TNS or TT  
Total Lightning Current 25 kA(10/350)
- SSPC12,5S/1+1S = 1 Pole Lightning arrester for TNS or TT  
Total Lightning Current 25 kA(10/350) + dist.sig.
- SSPC12,5/3+0 = 3 Poles Lightning arrester for TNC 12,5 kA (10/350)  
Total Lightning Current = 37,5 kA (10/350)
- SSPC12,5S/3+0 = 3 Poles Lightning arrester for TNC 12,5 kA (10/350) + dist.sig.  
Total Lightning Current = 37,5 kA (10/350)
- SSPC12,5/3+1 = 3 Poles Lightning arrester for TNS or TT  
Total Lightning Current 50 kA(10/350)
- SSPC12,5S/3+1 = 3 Poles Lightning arrester for TNS or TT  
Total Lightning Current 50 kA(10/350) + dist.sig.
- SSPC25 = 1 Pole Lightning arrester for TNC 25 kA (10/350)
- SSPC25S = 1 Pole Lightning arrester for TNC 25 kA (10/350) + dist.sig.
- SSPC25/1+1 = 1 Pole Lightning arrester for TNS or TT  
Total Lightning Current 50 kA(10/350)
- SSPC25S/1+1S = 1 Pole Lightning arrester for TNS or TT  
Total Lightning Current 50 kA(10/350) + dist.sig.
- SSPC25/3+0 = 3 Poles Lightning arrester for TNC 12,5 kA (10/350)  
Total Lightning Current = 75 kA (10/350)
- SSPC25S/3+0 = 3 Poles Lightning arrester for TNC 12,5 kA (10/350) + dist.sig.  
Total Lightning Current = 75 kA (10/350)
- SSPC25/3+1 = 3 Poles Lightning arrester for TNS or TT  
Total Lightning Current 100 kA(10/350)
- SSPC25S/3+1 = 3 Poles Lightning arrester for TNS or TT  
Total Lightning Current 100 kA(10/350) + dist.sig.



**POWER SUPPLY SYSTEMS LIGHTNING ARRESTER CLASS II**



SCF-230



SC-230



SSPU1-240S



SSPU3-240S



SCN-20

- SCF - 120 = Surge arrester 20kA (8/20)
- SCF - 230 = Surge arrester 20kA (8/20)
- SCF - 280 = Surge arrester 20kA (8/20)
- SCF - 400 = Surge arrester 20kA (8/20)
- SCF - 120 S = Surge arrester 20kA (8/20) + sig.
- SCF - 230 S = Surge arrester 20kA (8/20) + sig.
- SCF - 280 S = Surge arrester 20kA (8/20) + sig.
- SCF - 400 S = Surge arrester 20kA (8/20) + sig.
- SCT - 230 = Surge arrester 15kA (8/20)
- SCT - 280 = Surge arrester 15kA (8/20)
- SCT - 230 S = Surge arrester 15kA (8/20) + sig.
- SCT - 280 S = Surge arrester 15kA (8/20) + sig.
- SC - 120 = Surge arrester 15kA (8/20)
- SC - 230 = Surge arrester 20kA (8/20)
- SC - 280 = Surge arrester 20kA (8/20)
- SC - 400 = Surge arrester 15kA (8/20)
- SC - 120 S = Surge arrester 15kA (8/20) + sig.
- SC - 230 S = Surge arrester 20kA (8/20) + sig.
- SC - 280 S = Surge arrester 20kA (8/20) + sig.
- SC - 400 S = Surge arrester 15kA (8/20) + sig.
- SCN-20 = Encapsulated Gas Discharge Tube 20kA,  $U_c=255V/50\text{ Hz}, I_{max}=20\text{ kA}, U_p \leq 1,3\text{ kV}$
- SSPU 1 - 120 = 1 pole,  $U_N$  120V
- SSPU 3 - 240 S = 3 poles,  $U_N$  3x400/230V + sig.
- SSPU 1 - 240 S = 1 pole,  $U_N$  230V + sig.
- SSPU 1 - 240 = 1 pole,  $U_N$  230V
- SSPU 3 - 240 = 3 poles,  $U_N$  3x400/230V
- SSPU 3 - 120 = 3 poles,  $U_N$  3x208/120V
- SSPU 3 - 400 = 3 poles,  $U_N$  3x680/400V
- SPR 100 = Helping Connection Module

**POWER SUPPLY SYSTEMS LIGHTNING ARRESTER CLASS III**



SDL-32HFF



SDL-16HFF

SDL-25HFF



SDL-25HFFS



SD-16



SDI-16

- SDLTN = One phase protection for 230V
- SDL-25RFIS = Surge arrester 8kA (8/20), 230V, 25A + sig.
- SDL-8HFF = Surge arrester 8kA (8/20), 230V, 8A
- SDL-16HFF = Surge arrester 8kA (8/20), 230V, 16A
- SDL-16HFFS = Surge arrester 8kA (8/20), 230V, 16A + sig.
- SDL-25HFF = Surge arrester 8kA (8/20), 230V, 25A
- SDL-25HFFS = Surge arrester 8kA (8/20), 230V, 25A + sig.
- SDL-25RFIS = Surge arrester 8kA (8/20), 230V, 25A + sig.
- SDL-32HFF = Surge arrester 8kA (8/20), 230V, 32A
- SDL-32HFFS = Surge arrester 8kA (8/20), 230V, 32A + sig.
- SDL-50HFF = Surge arrester 8kA (8/20), 230V, 50A
- SDL-63HFF = Surge arrester 8kA (8/20), 230V, 63A
- SDL-80HFF = Surge arrester 8kA (8/20), 230V, 80A
- SDL-120HFF = Surge arrester 8kA (8/20), 230V, 120A
- SDL-150HFF = Surge arrester 8kA (8/20), 230V, 150A
- SDL-16/400HFF = Surge arrester 8kA (8/20), 400V, 16A
- SDL-16/400HFFS = Surge arrester 8kA (8/20), 400V, 16A + sig.
- SDL- 316HFFS = Surge arrester 8kA (8/20), 3x400/230V, 16A +sig
- SDL- 325HFFS = Surge arrester 8kA (8/20), 3x400/230V, 25A +sig
- SDL- 332HFFS = Surge arrester 8kA (8/20), 3x400/230V, 32A +sig
- SDL- 350HFFS = Surge arrester 8kA (8/20), 3x400/230V, 50A +sig
- SDL- 363HFFS = Surge arrester 8kA (8/20), 3x400/230V, 63A +sig
- SDL- 380HFFS = Surge arrester 8kA (8/20), 3x400/230V, 80A +sig
- SDI- 16 = Protected socket, 8kA (8/20), 16A
- SD- 4 = Protected socket with high freq. filter, 8kA (8/20), 6A
- SD- 16 = Protected socket with high freq. filter, 8kA (8/20), 16A
- SD-FAXRJ12 = Combined protection of suply and telephone network



**SCHIRTEC®**

## COMPUTER NETWORK PROTECTION



SD 2/100M - 5 cat  
SD 4/100M - 5 cat



SD 4/100M - 5 cat

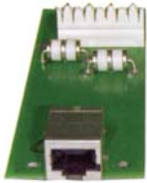

SD 2/100M - 5 cat

- SD 2/100M - 5 cat = Module for PC systems for 5 cat
- SD 1/100M - 5 cat = Module for PC systems for 5 cat
- SD 4/100M - 5 cat = Module for PC systems for 5 cat
- SCHIRTECNET 1. 2RJ/RJ = Module for PC systems for 5 cat
- SPSK 10 = Metal box
- SPSK 2/100M - 5 cat = Module for 2 pairs
- SPSK 4/100M - 5 cat = Module for 4 pairs
- SPSK 24 = Metal box
- SCHIRTECNET 8. RJ/RJ = Module for 8 stations, input and output RJ 45
- SCHIRTECNET 8.\*XC/RJ = Module for 8 stations, input XC and output RJ 45
- SCHIRTECTEL 8.1 RJ/RJ = Module for 8 stations, input and output RJ 45
- SCHIRTECTEL 8.2 RJ/RJ = Module for 8 stations, input and output RJ 45
- SCHIRTECTEL 8.1 LSA/RJ = Module for 8 stations, input LSA-plus and output RJ 45
- SCHIRTECTEL 8.2 LSA/RJ = Module for 8 stations, input LSA-plus and output RJ 45

## COAXIAL PROTECTION



SCO-1G  
SCO-2G



SCO-1P  
SCO-2P



SCO-10P



SCO-7/16

- SCO - 1P = for BNC connector
- SCO - 2P = for BNC connector
- SCO - 9P = for F connector
- SCO - 10P = TV connector
- SCO - 3GN (F/F) = for N connector
- SCO - 3GN (F/M) = for N connector
- SCO - 4GN (F/F) = for N connector
- SCO - 4GN (F/M) = for N connector
- SCO-1G = for BNC connector
- SCO-2G = for BNC connector
- SCO-9G = for F connector
- SCO-10G = TV connector
- SCO-11G = for UHF connector
- SCO-12G = for UHF connector
- SCO-7/16 = 7/16 connector (F/F)

## INSULATION LEVEL DROP DETECTOR



SIS-71



CE-500

- SIS 71 = Ins. level drop detector AC IT system (10-210kW)
- SIS 72 = Ins. level drop detector AC IT system (1-9kW)
- CE 500 = Inductor 3x500V

## EQUIPOTENTIAL BONDING (HIGH POWER GAS DISCHARGE TUBE)



SGDT-100-RW



SGDT-100

- SGDT-150-RW1
- SGDT-150-RW2
- (Isolating Spark Gap for Railway systems,  $I_{imp} = 150$  kA)
- SGDT-100 = Isolating Spark Gap,  $I_{imp} = 100$  kA
- SGDT-100-Ex = Ex Isolating Spark Gap,  $I_{imp} = 100$  kA
- SGDT-100-RW = Ex Isolating Spark Gap,  $I_{imp} = 100$  kA



# SURGE PROTECTION SYSTEMS

## Home and Office Application

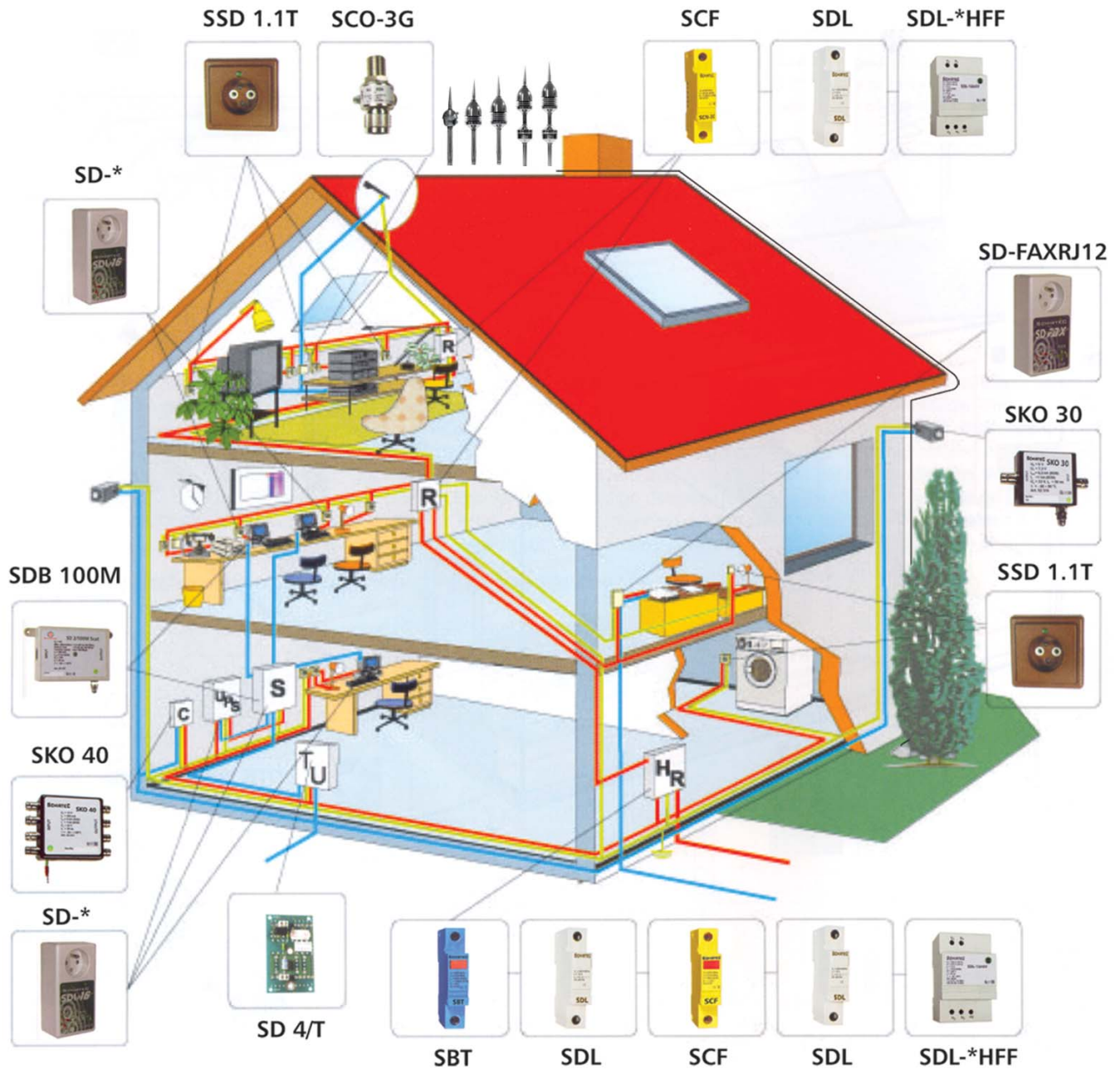

HR - Main switchboard  
 R - Subdistribution switchboard  
 TU - Tel. central  
 C - Security central  
 S - Server computer



# SCHIRTEC®



*Created For Your Safety*



**ICMET** **BET**  
BLITZSCHUTZ & EMV TECHNOLOGIEZENTRUM

**TÜV**  
ÖSTERREICH

**tgm**

Staatliche Versuchsanstalt



## SCHIRTEC AG

Ignaz-Köck Strasse 10,  
1210 Wien/Austria

Ph: +43 1 2703347 11 Fax: +43 1 2703347 49

[www.schirtec.at](http://www.schirtec.at) e-mail: [info@schirtec.at](mailto:info@schirtec.at)