

WORLD'S LARGEST BATTERY MANUFACTURER

257,533
EMPLOYEES*¹



62
BILLION
SALES*²



Panasonic INDUSTRY EUROPE GMBH (PIEU)

Panasonic Industry Europe GmbH is part of the global Panasonic Group and provides industrial products and services in Europe. As a partner for the industry sector, Panasonic researches, develops, manufactures and supplies technologies that contribute to a better life and a better world. Looking back on almost 100 years of engineering knowhow in electronics, Panasonic is the right supplier when it comes to engineering expertise combined with solution competence. The portfolio covers key electronic components such as batteries, devices and modules up to complete solutions and production equipment for manufacturing lines across a broad range of industries.

Panasonic ENERGY

Panasonic offers a wide range of power solutions for portable and stationary applications. Our product range includes high reliability batteries such as Lithium-Ion, Li-Ion Pin-type, Lithium, Nickel-Metal Hydride, Nickel-Cadmium, Valve-Regulated-Lead-Acid (VRLA), Alkaline,

and Zinc-Carbon. With this breadth and depth to the portfolio, we can power your business in virtually all applications.

Panasonic began manufacturing batteries in 1931 and is today the most diversified global battery producer worldwide, with an extensive network of manufacturing companies. The company employees are dedicated to research, development and production of batteries for an energised world.

*1 Employees of Panasonic Corporation

*2 Refers to the fiscal year ended March 2017 of Panasonic Corporation, based on exchange rate EUR/JPY 119.



PIEU OFFICE
IN HAMBURG



PIEU HEADQUARTER
IN OTTOBRUNN
(NEAR MUNICH)



ENERGY



INDUSTRY

Panasonic INDUSTRY EUROPE GMBH

PIEU

FACTORY SOLUTIONS



CERTIFICATIONS



'Quality is our Business' – this is what Panasonic stands for. It is the principle for all our batteries and supporting services. This commitment is confirmed by numerous certifications.



International Organization for Standardization



Our battery production facilities use leading-edge manufacturing processes that meet the toughest quality standards. All our factories are certified to ISO standards – with ISO 9000 and ISO 14000 being the minimum benchmarks. This means each factory has its own quality and environmental management, delivers products that measure up to toughest standards of reliability.

FIND THE RIGHT BATTERY FOR YOUR APPLICATION



BATTERY FINDER APP 3.0 FOR PROFESSIONALS

Designed for engineers, electronics specialists and developers who need batteries for their projects, the Battery Finder App provides an overview of what's available in the Panasonic range of industrial batteries, gives a recommendation on the type of battery that's best suited to the user's application. It also offers a wealth of information, graphics and videos on battery technology.

The features include:

- Completely redesigned version 3.0
- Improved intuitive usability
- Search for batteries using three different tools:
 - Parametric Search
 - Application Search
 - Model Number Search
- Current Panasonic range: now 237 batteries – including new Ni-Cd series and Lithium-Ion pin type battery
- Easy usage due to 'Drawer' menu
- Pictures and technical drawings of all products
- Product datasheets
- Favorites selection and sending to interested person
- Personal notes function
- Function for comparing up to 3 batteries based on technical details (only online application)
- Function for requesting product material in hardcopy or PDF format
- Function for recommendation
- Function for sending an inquiry
- Function to save images to smartphone gallery
- Extensive information on battery technology ('What is' glossary)
- Videos showing battery structure
- Direct link to Panasonic Battery Channel on YouTube
- Information about Panasonic company
- All contact details for Panasonic Industry Europe GmbH

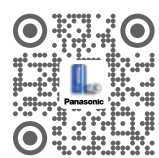



SMARTPHONE APP



HTML APP



Home screen

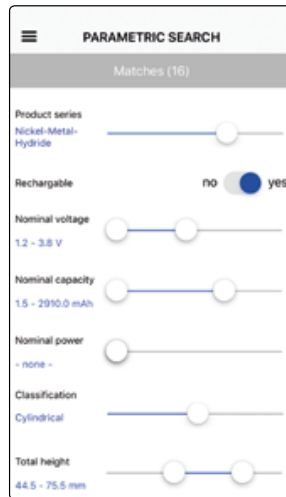

Parametric Search

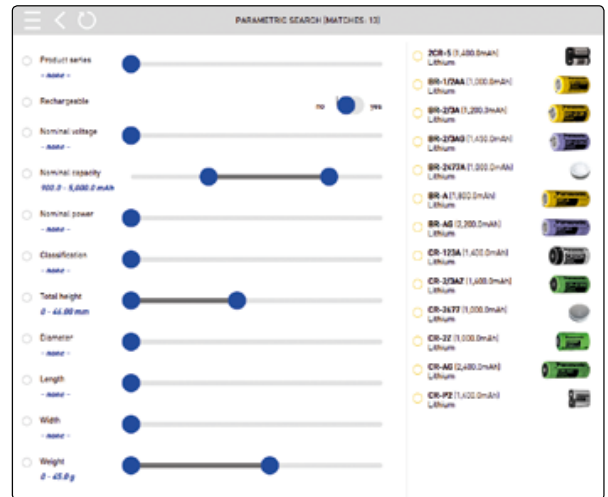

Parametric Search

Version 3.0 of the Battery Finder Smartphone App has been fully revised and is packed with a host of practical new features. The new home screen navigates users even faster to the functions they're looking for. Thanks to the Parametric Search, it's easier than ever to locate the right battery – and parameters can even be combined. There's also an enhanced battery information screen, with options to make and save notes. And last but not least, Battery Finder 3.0 makes it more intuitive and faster to locate applications. These are just a few examples of the many new possibilities.

The newly designed Battery Finder HTML App 3.0 also has plenty of innovative features in store. The design is identical to that of the smartphone app, making it easier for users to switch seamlessly between mobile devices and PCs. The battery information screen provides all the available information on the selected battery, with a layout that ensures clarity of presentation. The Parametric Search makes it easier to locate the right battery; there is a wide choice of parameters, and options can also be combined. The extended favorites function now offers detailed comparisons of up to three batteries. All in all – it's now easier than ever to find the right battery!

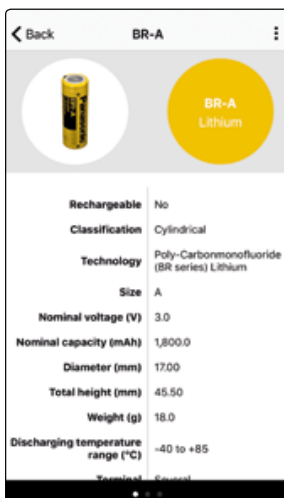

Battery information screen



Application Search



Battery information screen

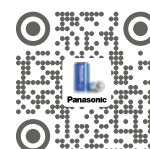



MEDIAPOOL

DOWNLOAD THE RIGHT BATTERY MEDIA FILES

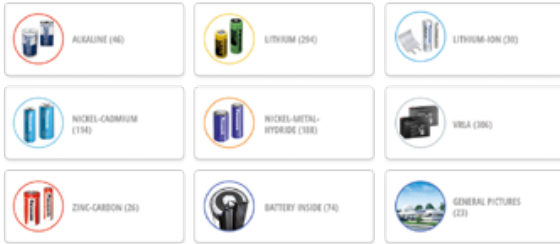

The Panasonic Mediapool is a complete online library of Panasonic battery images, videos, handbooks, press releases, and white papers, providing you with just the right material for all sorts of projects. The Mediapool is open to all visitors to the Panasonic website, and offers material for both print and web. The image files differ with respect to their resolution (image size) and colour space (CMYK or RGB). The library contains files in five formats: TIF, PNG, JPG, AI, PDF, and MP4.

NEW

- New categories: Handbooks & leaflets / White paper / Battery inside
- Single downloading files
- Improved usability

New files appear in the folder 'New files' for three months.

You can assemble as many files as you need and download them directly to your computer. Here's an overview of what you can do:

- Locate the material you need by product name or by clicking through the categories
- Preview file details – the preview function tells you the full name of the file, its size, format, and resolution
- Select the files you wish to download. You can take files from multiple folders, or select all the material in a particular folder or category in one-click operation – there's no need to select each one individually
- Preview your personal 'Download bag' of the files you have selected
- The Mediapool zips your data into a file, which you then download to your computer. You unzip the file to the location of your choice simply by double-clicking the file name. The material is then ready for use.

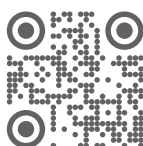

YOUTUBE CHANNEL

FIND THE RIGHT BATTERY VIDEO



Please find a comprehensive selection of Panasonic battery videos at our YouTube Channel. You can discover videos about the inner structure of our different battery chemistries, a video which gives you a clear insight about 'green' battery applications and last but not least a video which explains the working of our Battery Finder App in detail. Find out how we can power your business!



Panasonic Battery Finder Update 3.0 – App & Online Version

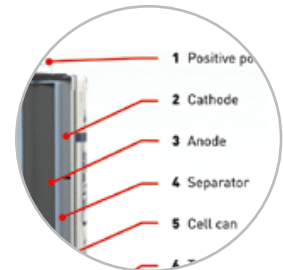

How looks an Alkaline battery inside? video



Panasonic Good Energy – Smoke detector



Panasonic Ni-MH battery solution video for professionals

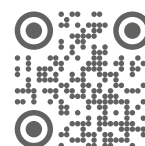



WHITE PAPER

FIND THE RIGHT
TECHNICAL INFORMATION

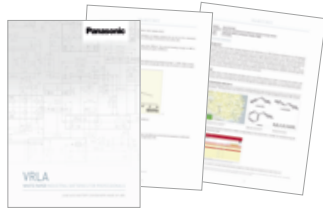

Panasonic is offering a new service: our white papers provide detailed, unbiased insights into various aspects of battery technology.

White papers are publicly available documents written by specialists on a specific technical issue. As such, they are of considerable value to professional users. White papers can be downloaded and freely disseminated. They are also routinely quoted in technical publications, and contain not only explanatory text, but also images and graphics, tables, charts and links.

Our white papers give developers and technical professionals the opportunity to leverage the expertise of our specialists for their own projects. We have been manufacturing batteries for a number of decades, and over this time have accumulated considerable knowledge and experience that we wish to share.

The first white paper is titled 'Lead acid battery containers made of ABS' and takes a detailed look at the experience of our engineers with the material ABS for VRLA containers. One of the issues addressed is the extent to which tensioned mounting straps can have a negative impact on the battery container. As well as a full description, the document provides valuable recommendations on the subject.

In the near future there will be a whole series of white papers with detailed insights into battery technology. We will let you know when the next one is out!

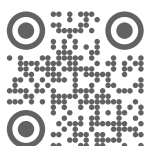

SHORT FORM CATALOG AND HANDBOOKS

GET THE RIGHT PRODUCT OVERVIEW



Our range of digital tools to help you in your daily work are complemented by our 'classics' on paper: the Short Form Catalog and the handbooks on the various battery product groups. These remain popular with customers as valuable reference aids.

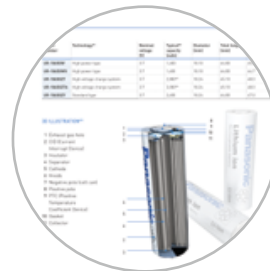

Short Form Catalog – a compact summary of all the batteries

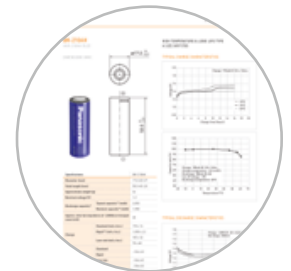

Ni-MH handbook – details about all the batteries of this particular chemistry



Short Form Catalog – an overview of latest news and innovations



Short Form Catalog – QR codes provide fast access to relevant information

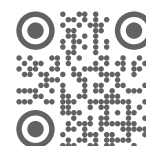

INDEX

CHAPTER	PAGE
COMPANY	2 – 3
BATTERY FINDER	4 – 5
MEDIAPOOL	6
YOUTUBE CHANNEL	6
WHITE PAPER	7
SHORT FORM CATALOG AND HANDBOOKS	7
INDEX	8
PRECAUTIONS FOR HANDLING VRLA BATTERIES	9 – 13
VRLA BATTERIES	14 – 16
CHARACTERISTICS	17 – 19
CHARGING METHODS	20 – 23
TERMINAL DATA	24
SAFETY / SAFETY DESIGN	25 – 26
BATTERY LABEL DESIGN	27
MODEL NUMBERS OF VRLA BATTERIES	28 – 29
STANDARDS	30 – 31
BATTERY SELECTION	32
BATTERY INDEX	33 – 37
INDIVIDUAL DATA SHEETS	38 – 143
GLOSSARY OF MAIN BATTERY TERMS	144 – 146
CONTACT	148

This document should be read in its entirety and its contents fully understood before handling or using Panasonic rechargeable sealed lead acid batteries. If there are any questions, please contact Panasonic. Please keep this document available for reference. Due to the potential energy stored in the batteries, improper handling or use of the batteries without understanding this document may result in injury caused by electrolyte leakage, heat generation, or explosion.

DEGREE OF DANGER

Danger

When the batteries are handled or used improperly, death or severe injury may occur.

Warning

When the batteries are handled or used improperly, death or severe injury may occur, and slight injury or loss of products often occur.

Caution

When the batteries are handled or used improperly, slight injury may occur and damage to the batteries and equipment may occur.

Request

When the batteries are handled or used improperly, damage to quality or performance may occur.

Note 1

Improper handling and use of the batteries may cause dangerous conditions to arise. All precautions should be taken to prevent any harmful effects from the use of the batteries.

Note 2

'Severe injury' as a result of improper handling or use of the batteries may include but are not limited to loss of eyesight, injury/burn/electric shock/fracture of a bone/poisoning with after effect, or injury that requires long-term medical treatment. 'Slight injury' covers such conditions as burns or electric shock that do not require long-term medical treatment. Damage to products is defined as extensive damage to a house, a house hold effects, a livestock, or pets.

Note 3

'Requests' are meant to prevent a decrease in the quality or the performance of the batteries.

ENVIRONMENT AND CONDITION

Danger

1. Do not put the batteries into airtight containers or bags. The batteries tend to generate inflammable gas upon excess charge which may cause an explosion if enclosed in an airtight container.

Warning

1. The batteries must be charged using the specified charger or by maintaining the charging conditions indicated by Panasonic. If the batteries are charged under conditions other than those specified by Panasonic, they may leak, generate excessive heat, or explode.
2. When using the batteries in medical equipment, incorporate a back-up system other than the main battery in the event of power failure.
3. Insert insulation that is resistant to heat and sulfuric acid between the batteries and any metallic housing. Failure to do so may cause the batteries to smoke or burn in case of electrolyte leakage.
4. Do not place the batteries near a device that may generate sparks (such as a switch or fuse) and do not place the batteries close to fire. The batteries may generate an inflammable gas when charged excessively that may ignite upon contact with a spark or they may burn or explode due to sparks or fire.

Caution

1. Use or store the batteries in the temperature range: Discharge (operating in application): -15°C ~ 50°C. Charge: 0°C to 40°C. Storage: -15°C to 40°C. Temperatures above or below those recommended could result in damage or deformity of the batteries.
2. Avoid placing batteries near a heat-generating device (such as a transformer) which may cause the batteries to generate excessive heat, leak or explode.
3. Do not allow the batteries to be exposed to rain or sea water. If the battery terminals should get wet, they may corrode.
4. Do not use or store the batteries in a car under the blazing sun, in direct sunlight. To do so may cause the batteries to leak, generate excessive heat, or explode.
5. Do not use or store the batteries in a dusty place as dust may cause them to short circuit between their terminals. When using the batteries in a dusty place, check them periodically.
6. In applications requiring more than one battery, first connect the batteries together and then connect the batteries to the charger or the load. Be careful to connect the (+)pole of the batteries to the (+)terminal of either the charger or the load. Improperly connecting

PRECAUTIONS FOR HANDLING VRLA BATTERIES

the batteries, charger, or load may cause an explosion or fire to occur. In some cases, bodily injury may occur.

7. When handling the batteries, wear steel-tipped shoes to prevent possible injury to the feet if the batteries are accidentally dropped.

Request

1. Dropping a battery may cause a strong physical shock that may damage the performance of the battery.
2. Confirm the life of the batteries using the real load and charger. Differences in the charging and the discharging conditions may cause a big difference in the life of the batteries.

INSTALLATION

Danger

1. Tools such as wrenches used to install the batteries should be insulated. Bare metal tools may cause an abnormal short circuit accident to occur resulting in bodily injury, damage to the batteries, explosion or fire.
2. Do not install the batteries in a room without ventilation. The batteries tend to generate an inflammable gas upon excess charge resulting in an explosion or fire if the room is closed.

Warning

1. Do not contact any plastic or resin*1 which contains a migrating plasticizer with the batteries. Furthermore, avoid using organic solvents such as thinner, gasoline, lamp oil, benzine and liquid detergent to clean the batteries. The use of any of above materials may cause the containers and/or the covers (ABS resin) of the batteries to crack and leak. This may cause a fire in the worst scenario. Make sure the use of material will not cause the containers and/or the covers of the batteries to crack due to the migration of plasticizer within the material by asking the manufacturer of the material if necessary.
2. Always use such as rubber gloves when handling batteries with the voltages higher than 45V in order to prevent severe bodily injury from occurring.
3. Do not install the batteries in areas where they may come in contact with water. If the batteries come in contact with water, an electric shock may occur.

Caution

1. During unpacking, handle the batteries carefully and check for cracks, breakage, or electrolyte leakage. Failure to handle carefully may result in damage due to physical shock.

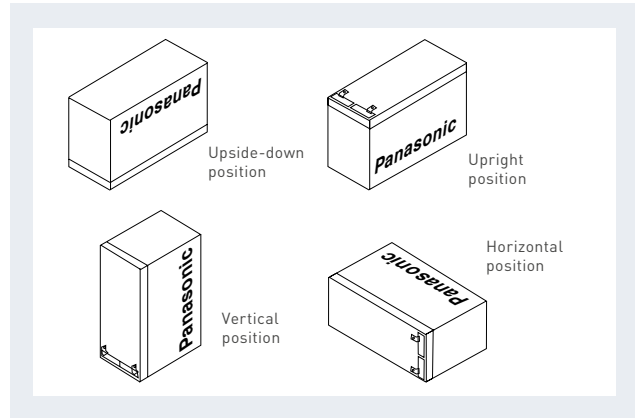

2. When the batteries are being mounted in the equipment, consider the best position for easy checking, maintenance and replacement. In addition, the batteries should be located in the lowest part of the equipment as possible. The rechargeable sealed lead acid batteries, mentioned in this document, are designed for use in any position, **but charging the batteries in the upside-down position should be avoided**. When these batteries are charged excessively in the upside-down position, leakage of electrolyte from the rubber vents may occur. The upside-down is shown on the previous page. In this upside-down position, the mark 'Panasonic' on the battery is turned upside down. The drawings are only for explanation of the battery's position; therefore these are not equal to the real appearance of the battery that the specifications describe. Can be used in the vertical position and the sidedown position (maximum angle of 90°C from the normal position).
3. Do not carry the batteries by picking up them by their terminals or lead wires. To do so may damage the batteries.
4. Be careful not to jolt the batteries as it may result in damage to them.
5. Be aware the batteries are relatively heavy compared to their volume. Please be careful to carry these batteries in order to avoid injury and/or lumbago.
6. Do not cover the batteries with plastic sheet as it may cause a fire or an explosion by conducting static electricity.
7. Fasten the bolts and the nuts with the torque as shown on page 11: Not to do so may cause the battery terminals to break.

*1 Examples for plastic or resin which should be avoided using: vinyl chloride, oily rubber.

Examples for plastic or resin which is proper for the use: Polyolefin resin such as polypropylene, polyethylene.

Bolt (nut) size (mm)			Fastening torque (Nm)
Diameter	Pitch	Length	
M5 (5)	0.8	15 ± 1	2.0 - 3.1
M6 (6)	1.0	20 ± 1	4.1 - 5.6
M8 (8)	1.25	20 ± 1	8.2 - 10.2
M10 (10)	1.5	25 ± 1	14.7 - 19.7

- Place the necessary insulating covers over the terminals, the connecting bars, and bolts and nuts to prevent a dangerous electric shock.
- Please consult Panasonic prior to using the batteries in applications such as a motor bicycle, an engine driven lawn mower, etc. which may generate severe vibration.
- Fasten the batteries firmly to the equipment to avoid the influence of vibration and/or physical shock.

Request

- The batteries should be installed by a certified technician.

PREPARATION PRIOR TO OPERATION

Danger

- Be sure to provide enough insulation around the lead wires and/or plates used between the batteries and the application. Insufficient insulation may cause an electric shock. Heat generating from a short circuit (or excess current) may result in an injury, burn, smoke or fire.

Caution

- Do not plug the batteries directly into the outlet or the cigarette receptacle of a car without inserting a charger between the batteries and the outlet or the receptacle. To do so may cause electrolyte leakage, heat generation, or explosion of the battery.
- Turn off the circuit switch when the connections between the batteries and the charger/load are made.
- When using the batteries for the first time, check for rust, heat generation, or any other abnormalities. If found, do not use as it may cause electrolyte leakage, heat generation, or explosion.

Request

- Since the batteries tend to lose a part of their capacity due to self-discharge during shipment and storage, recharge the batteries before you use them after purchase or long-term storage in order to restore their full capacity. Check for the following conditions before recharge:

Charging method	Charging condition (at 20°C)
Constant voltage	<ul style="list-style-type: none"> ○ Regulation range of the controlled voltage: 7.25V to 7.45V/6V battery, 14.5V to 14.9V/12V battery; initial current: 0.1CA to 0.4CA; maximum charging time: 24 hours. ○ Short-time charge is possible when several batteries of the same model, under the same storage conditions can be charged in series. Otherwise they can be charged separately.
Constant current	<ul style="list-style-type: none"> ○ Charging current: 0.1CA ○ Charging time (hours) = [Amount of self-discharge (Ah)/0.1CA] x 120% ○ Rough estimation of amount of self-discharge is as follows (for an example): When the storage ambient temperature is lower than 20°C, and storage time is known, assume the following amount of self-discharge: [5%/month] x storage months ○ Multiply this by the rated capacity (at 20 hours rate) of the battery. ○ Regardless of the above calculation, the charge time for a refresh charge must be less than 12 hours. ○ When the storage ambient temperature is higher than 20°C, please consult Panasonic.

UNSPECIFIED USE

Caution

- Do not place the batteries in an unspecified use or they may leak, generate heat, or explode.

METHOD OF HANDLING AND OPERATION

Danger

- Do not directly connect the positive and negative terminals with a conductive material such as a wire. Be careful while using a metal tool such as a wrench and/or carrying the batteries with metallic necklaces and hairpins not to make a short circuit. A short circuit of the battery's terminals may cause a heat generation, an explosion, or a fire.

Warning

- Never dispose the batteries in a fire as it may cause them to explode or generate a toxic gas.
- Do not attempt to disassemble the batteries as it could cause leakage of Sulfuric acid that could cause injury.

Caution

- To prevent accidents from happening, change any battery that is found to have an abnormality such as a crack, a deformity, or leakage. The batteries must be kept clean and free from dust to prevent loss of capacity or accident.

PRECAUTIONS FOR HANDLING VRLA BATTERIES

2. If any abnormality of the charge voltage or the discharge voltage is detected, replace the batteries with new ones.
3. Charging the batteries with an inverse polarity connection between the batteries and the charger could cause electrolyte leakage, heat generation, or a fire.
4. Do not solder directly on the batteries' terminal tabs. Soldering directly on the batteries' terminals may cause a leak of electrolyte. Consult Panasonic when soldering is necessary.
5. Avoid the use of the batteries differing in capacity, type, history of use (charge/discharge operation). These differences could cause electrolyte leakage or heat generation.
6. Do not remove or scratch the outer tube of the battery or it may cause an electrolyte leakage or electrical leakage.
7. Do not allow the batteries to be subjected to any strong physical shocks or jolts while moving them. Treating the batteries roughly could cause leaks, heat generation, or explosions.
8. Do not charge the batteries beyond the amount of the time indicated in the specifications, or do not charge after the charge indication lamp indicates a full charge. Take the batteries off the charger if the charge is not finished after the specified charge time. Over-charging can cause leakage, heat generation, or explosions.
9. Children should be taught how to handle and use the batteries correctly.
10. Keep the batteries out of the reach of small children at all times.

Request

1. The cut-off voltage during discharge should vary depending on the discharge current. Do not discharge the batteries lower than the recommended cut-off voltage shown in Panasonic specifications or Panasonic technical handbooks. Recharging a battery which was once discharged below the recommended cut-off voltage may generate heat, resulting in the deformation of the battery or in condensation around the battery cover caused when moisture within the battery evaporates. In addition, the efficiency of the battery would eventually decrease. Overdischarging a battery may result in reduced performance. Always recharge the batteries immediately after discharge even if the batteries were not discharged to the recommended cut-off voltage. If the batteries are not charged soon after discharge, the batteries performance may be reduced due to the so-called 'sulfation phenomena'.
Note: The cut-off device to prevent overdischarge should cut off all discharge current including any weak current.
2. Thoroughly study the charge methods and the conditions of the batteries before adopting other charge

methods which are not shown in the Panasonic specifications or the Panasonic technical handbook, for safety reasons.

3. When the batteries are used in a cyclic application, it is important to charge the batteries for the proper amount of time. A timer should be incorporated into the charging circuit that will disconnect the charging current to prevent overcharging. Also, it is important to allow the battery to completely charge before removing the battery from the charger.
4. Avoid parallel charging of the batteries in cycle use. This may shorten the life of the batteries by causing an imbalance in the charge/discharge operation of the batteries.
5. Measure the total voltage of the batteries during trickle charge (or float charge), using a voltage meter. If the total voltage of the batteries provide an indication deviating from the specified voltage range, be sure to investigate the cause. If the total voltage is lower than that specified, the batteries may lose their capacity because of a lack of sufficient charge. However, if the total voltage is higher than that specified, the batteries may lose their capacity by damage due to overcharge and may suffer from 'thermal runaway' and other accidents.
6. Switch off the equipment after use to prevent loss of performance or shortened life of the batteries due to damage by overdischarge.
7. When storing the batteries, be sure to remove them from the equipment or disconnect them from the charger and the load to prevent overdischarge and loss of capacity. Before storing batteries, charge the batteries fully. Do not store batteries in a highly humid place to prevent rust from forming on the terminals.

MAINTENANCE

Warning

1. When cleaning the batteries, use a soft damp cloth. A dry cloth may cause static electricity which could result in a fire or explosion.
2. Replace batteries with the new ones before the end of their useful life as determined in the specifications. When the batteries are near the end of their life (50% state of their initial discharge duration time) the remaining life will shorten remarkably. Finally the batteries will lose their available capacity by either drying out their electrolyte (causing increase in their impedance) or an internal short-circuit. In such case, if the batteries go on charging, thermal runaway and/or leakage of electrolyte may occur. The batteries should be replaced before reaching these conditions.
The expected life of the batteries (in trickle or float

use) will decrease to half (50%) with each 10°C rise in temperature above 20°C. In particular, the life of the batteries will be shortened remarkably at approximately 40°C. Accordingly, precautions are required to prevent the use of batteries at high temperatures.

Caution

1. Avoid using organic solvents such as thinner, gasoline, lamp oil, or benzine, and liquid detergent to clean the batteries. These substances may cause the battery containers to crack or leak.

Request

1. Keep the battery terminals clean in order to avoid interruption in the discharge and/or to maintain the charge.

TREATMENT AT EMERGENCY

Warning

1. The batteries have toxic liquid – dilute sulfuric acid solution in them. If the acid comes into contact with skin or clothes, wash skin or cloth with lots of clean water to prevent scalding from occurring. If the acid should come into contact with the eyes, wash the eyes with lots of clean water and consult a physician immediately to prevent possible loss of sight.

Caution

1. Check the batteries visually for any sign of irregularities in appearance. If any damage exists such as cracks, deformation, leakage of electrolyte, or corrosion, the batteries must be replaced with the new ones. Irregularities in the batteries could result in bodily injury, electrolyte leakage, excessive heat generation, or explosion, if used. Furthermore, make sure the batteries are clean and free from dirt and dust.

STORAGE

Caution

1. Store the batteries in a fixed position separate from metal or other conductive materials.
2. Keep the batteries from rain water that could cause corrosion on the terminals of the batteries.
3. Keep the batteries right-side-up during transportation and do not give any abnormally strong shock and jolt to the batteries. Transporting the batteries in an abnormal position or handling them roughly could destroy the batteries or cause their characteristics to deteriorate.
4. When storing the batteries, be sure to remove them from the equipment or disconnect them from the charger

and the load, then store them at room temperature or lower temperature. Do not store the batteries at direct sunlight, higher temperature or high humidity. To do so cause the batteries short life, performance deterioration or corrosion on terminals.

Request

1. Charge the batteries at least once every twelve months if they are stored at 20°C. Use the charge method specified in '4. Charging methods'. The interval of this charge should be reduced to 50% by each 10°C rise in temperature above 20°C. The self-discharge rate doubles for each 10°C in temperature. If they are stored for a long time in a discharged state, their capacity may not recover even after charge. If the batteries are stored for more than a year at room temperature, the life of the batteries may be shortened.
2. Store the batteries starting from the fully charged state to prevent the life of the batteries being shortened.
3. Use the batteries as quickly as possible after receiving them as they gradually deteriorate even under proper storage conditions.

DISPOSAL AND RECYCLING

Caution

1. Please write the information about battery recycling on the equipment, the package, the carton, the instruction manual etc. in countries where legal or voluntary regulations on battery recycling are applicable.
2. Design the equipment such that exchange and disposal of the batteries can be undertaken easily.
3. Used batteries should be recycled. When returning used batteries, insulate their terminals using adhesive tape, etc. Even used batteries still have electrical charge and an explosion or a fire may occur, if proper insulation is not given on the terminals of the used batteries.

OUTSTANDING QUALITY FOR DEMANDING APPLICATIONS



STATE-OF-THE-ART AGM TECHNOLOGY
SUPERIOR DESIGN AND LOW VOLTAGE SPREAD
HIGHEST QUALITY CONTROL STANDARDS
ENHANCED LIFESPAN DUE TO EXCELLENT
RECOMBINATION EFFICIENCY

BATTERY CONSTRUCTION

Positive plates

Positive plates are plate electrodes of which a grid frame of lead-calcium-tin alloy holds porous lead dioxide as the active material. The magnification of a positive active material is shown on following figure 1.

Fig. 1 Magnification of positive active material

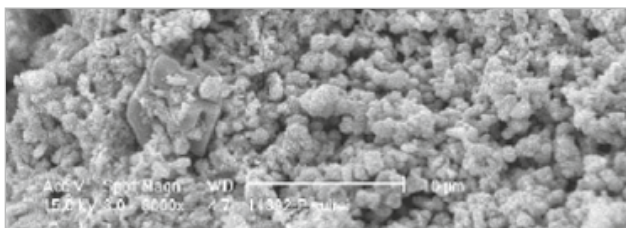

Negative plates

Negative plates are plate electrodes of which a grid frame of lead-calcium-tin alloy holds spongy lead as the active material. The magnification of a negative active material is shown on following figure 2.

Fig. 2 Magnification of negative active material

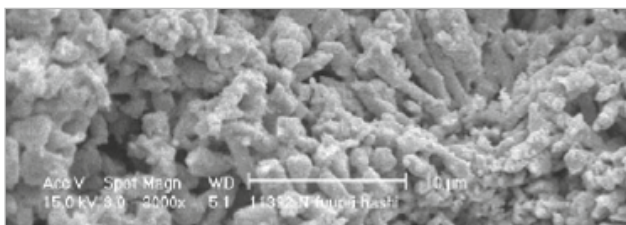

Electrolyte

Diluted sulfuric acid is used as the medium for conducting ions in the electrochemical reaction in the battery. Some additives are included to keep good recovery performance after deep discharge.

Scan QR code
to view product
series video.



Separators

Separators, which retain electrolyte and prevent shorting between positive and negative plates, adopt a non-woven fabric of fine glass fibers which is chemically stable in the diluted sulfuric acid electrolyte. Being highly porous, separators retain electrolyte for the reaction of active materials in the plates. Typical magnification of separator is shown in following figure 3.

Fig. 3 Typical magnification of separator

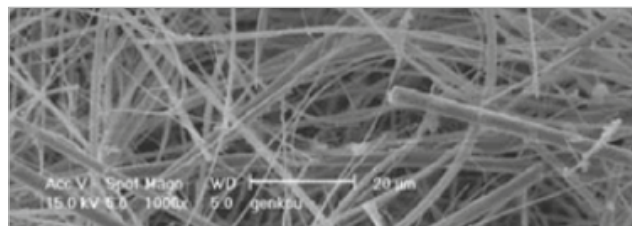

Vent (one way valve)

The valve is comprised of a one-way valve made of material such as Neoprene. When gas is generated in the battery under extreme overcharge condition due to erroneous charging, charger malfunctions or other abnormalities, the vent opens to release excessive pressure in the battery and maintain the gas pressure within specific range (7.1 to 43.6kPa). During ordinary use of the battery, the vent is closed to shut out outside air and prevent oxygen in the air from reacting with the active material in the negative electrodes.

BATTERY CASE MATERIALS (EXAMPLE LC-R SERIES)*1

- 1 Negative plate terminal
- 2 Seals
- 3 Positive plate terminal
- 4 Battery case
- 5 Positive electrode
- 6 Separator
- 7 Negative electrode
- 8 Valve

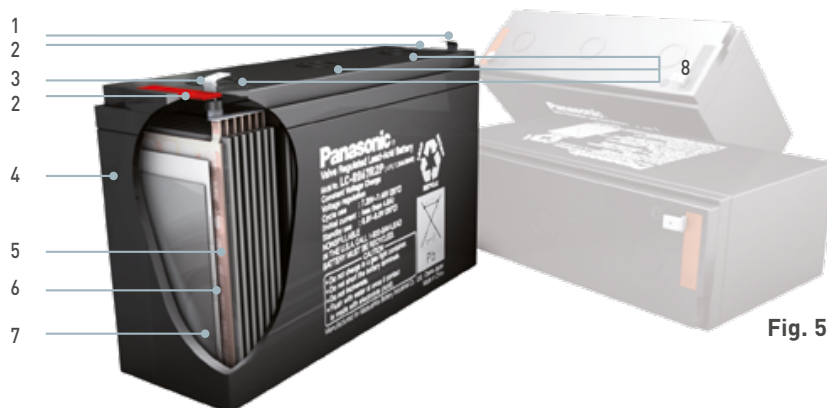
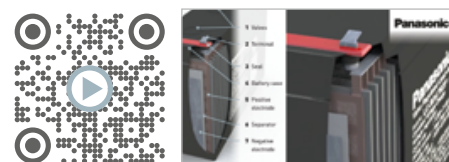

Fig. 5

Positive and negative electrode terminals

Positive and negative electrode terminals may be faston tab type, bolt fastening type or threaded post type, depending on the type of the battery. Sealing of the terminal is achieved by a structure which secures long adhesive-embedded paths and by the adoption of strong epoxy adhesives. For specific dimensions and shapes of terminals see page 24.

Scan QR code to view 3D animated video.



Battery case materials and the design

Materials of the body and cover of the battery case are ABS resins, unless otherwise specified. Since the inside of VRLA battery is pressurized and depressurized, stress occurs at the container and cover. The design according to the stress is designed to accommodate the fluctuations in stress in the event the battery becomes deformed. The thickness of container, form, material and stress analysis are determined by utilization of computer aided engineering (CAE). This depicts the container design & strength. Destructive examinations using the molded container are also carried out. In other cases in which water in electrolyte liquid may penetrate through container in service life, the container design is put through water penetration tests.

ELECTROCHEMICAL REACTIONS ON ELECTRODES

The electrochemical reaction processes of the sealed lead acid battery (negative electrode recombination type) are described below. Where 'charge' is the operation of supplying the rechargeable battery with direct current from an external power source to change the active material in the negative plates chemically, and hence to store in the battery electric energy in the form of chemical energy. 'Discharge' is the operation of drawing out electric energy from the battery to operate external equipment. In the final stage of charging, an oxygen-generating reaction occurs at the positive plates. This oxygen transfers inside the battery, then is absorbed into the surface of the negative plates and consumed. These electrochemical reaction processes are expressed as follows.

Fig. 4 CAD container design

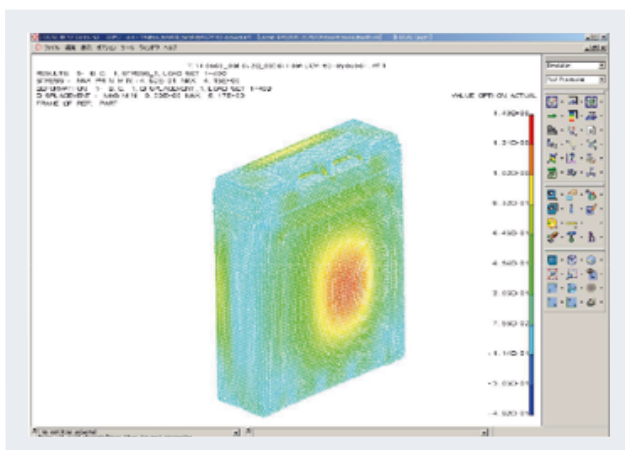

APPLICATIONS

Standby / Back-up power applications

- Communication equipment: base station, PBX, CATV, WLL, ONU, etc.
- Back-up for power failure: UPS, ECR, computer system back-up, sequencers, etc.
- Energy saving: solar and/or wind powered lanterns, wind powered advertising displays, etc.
- Emergency equipment: lights, fire and burglar alarms, radios, fire shutters, stop-position controls (for machines and elevators), etc.

Main power applications

- Electrically operated vehicles: picking carts, automated transports, electric wheelchairs, cleaning robots, electric automobiles, electric lawnmowers, etc.

*1 The illustration shows only one example of VRLA battery structure.

- Tools and engine starters: scooters, jet-skis, APUs, etc.
- Industrial equipment/instruments and non life-critical medical equipment*1: infrastructure back-up, railroad signalling, measuring equipment, respirator back-up, heartbeat monitor, wheelchair, stairlift, operation table, eelectrocardiograph, etc.
- Photography: camera strobes, VTR/VCR, movie lights, etc.
- Toys and hobby: radio-controllers, motor drives, lights, etc.
- Miscellaneous uses: tape recorders, other portable equipment, etc.

FEATURES

Leak-resistant structure

A required-minimum quantity of electrolyte is impregnated into, and retained by, the positive and negative plates and the separators; therefore electrolyte does not flow freely. Also, the terminal has a sealed structure secured by long adhesive-embedded paths and by the adoption of strong epoxy adhesives which makes the battery leak-resistant. Note: In standby/back-up uses, if the battery continues to be used beyond the point where discharge duration has decreased to 50% of the initial (i.e. life judgment criteria), cracking of the battery case may occur, resulting in leakage of the electrolyte.

Long service life

Service life of our long-life series (LC-P, UP-PW, LC-X series) is approximately double that of the conventional (LC-R and UP-RW series) batteries (temperature 20°C), discharge rate 0.25CA/1.75V/cell, discharge frequency every 6 months, 2.30V/cell charge).

Easy maintenance

Unlike conventional batteries in which electrolyte can flow freely, VRLA batteries do not need the specific-gravity check of the electrolyte or the water top up maintenance, this allows the battery to function fully with the minimum of maintenance.

No Sulfuric acid mist or gases

Unlike conventional batteries in which electrolyte can flow freely, VRLA batteries generate no Sulphuric acid mist or gases under Panasonic recommended use conditions. If used under conditions other than recommended then gas generation may occur, therefore do not design the battery housing in a closed structure.

Exceptional deep discharge recovery

Our VRLA batteries show exceptional rechargeability even after deep discharge, which is often caused by failure to turn off the equipment switch, followed by standing (approx. 1 month at room temperature is assumed).

Fig. 6 Charge / discharge chemical equation

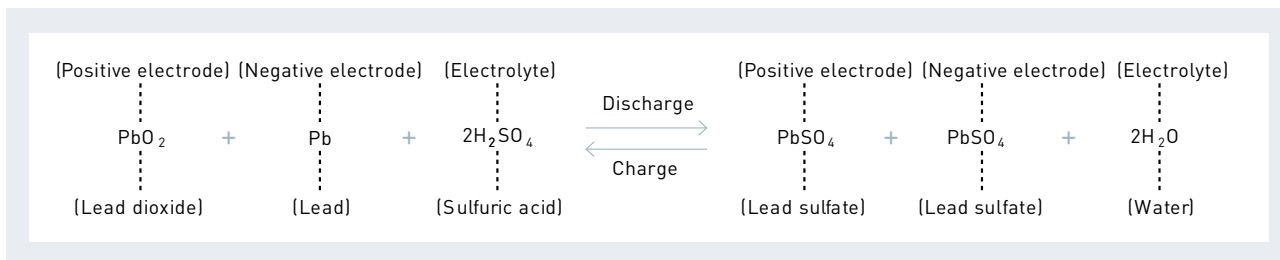
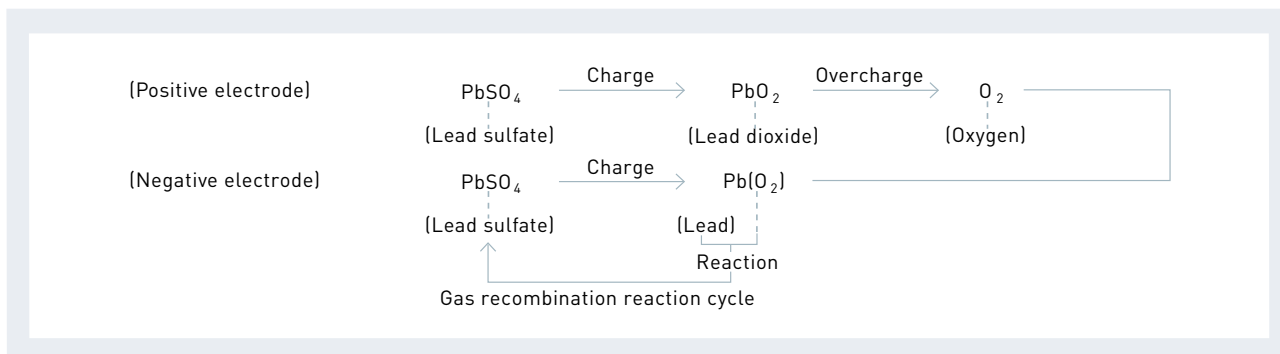

Fig. 7 Recombination chemical equation



CHARGING

Charge characteristics (constant voltage-constant current charging) of VRLA batteries are exemplified in the figure 1. In order to fully utilize the characteristics of VRLA batteries, constant-voltage charging is recommended. For details of charging see pages 20 – 23.

Fig. 1 Constant-voltage charge characteristics by current (example)

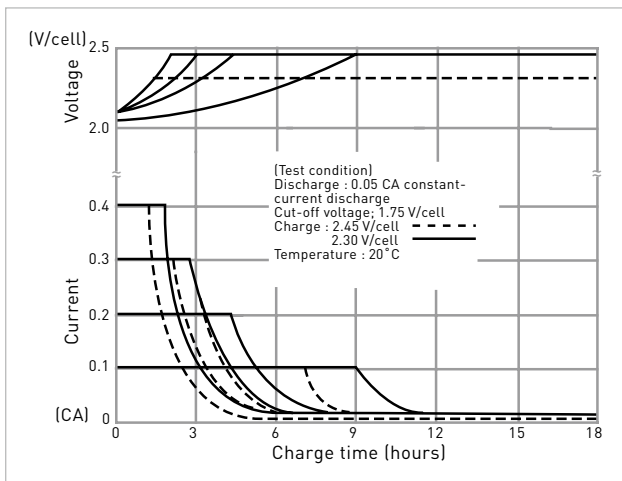

DISCHARGING

Discharge current and discharge cut-off voltage

Recommended cut-off voltages for 6V and 12V batteries consistent with discharge rates are given in the figure 2. With smaller discharge currents, the active materials in the battery work effectively, therefore discharge cut-off voltages are set to the higher side for controlling overdischarge. For larger discharge currents, on the contrary, cut-off voltages are set to the lower side. **Note:** Discharge cut-off voltages given are recommended values.

Fig. 2 Discharge current vs. cut-off voltage

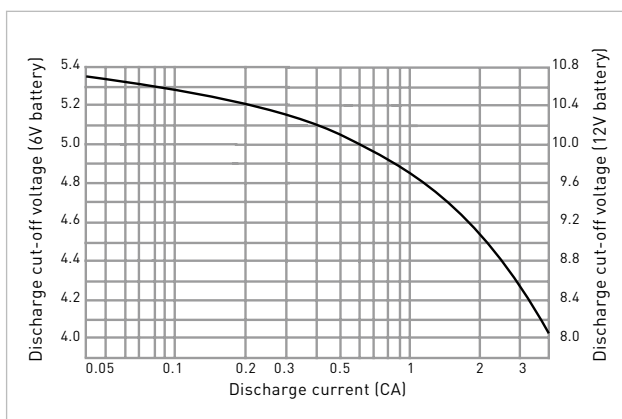

Discharge temperature

Control the ambient temperature during discharge within the range from -15°C to 50°C for the reason described below.

Batteries operate on electrochemical reaction which converts chemical energy to electric energy. The electrochemical reaction is reduced as the temperature lowers, thus, available discharge capacity is greatly reduced at temperatures as low as -15°C. For the high temperature side, on the other hand, the discharge temperature should not exceed 50°C in order to prevent deformation of resin materials which house the battery or deterioration of service life.

Effect of temperature on discharge characteristics

Available discharge capacity of the battery varies with ambient temperature and discharge current as shown in the figure 3.

Fig. 3 Discharge capacity by temperature and by discharge current

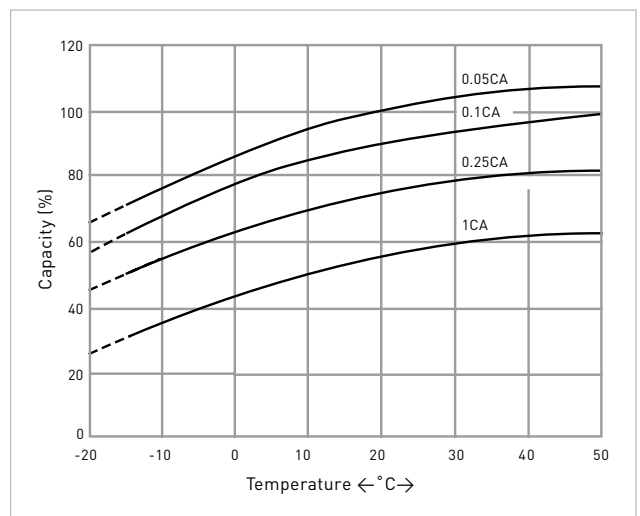

Discharge current

Discharge capability of batteries is expressed by the 20 hours rate (rated capacity). Select the battery for specific equipment so that the discharge current during use of the equipment falls within the range between 1/20 of the 20 hours rate value and 3 times that (1/20CA to 3CA): discharging beyond this range may result in a marked decrease of discharge capacity or reduction in the number of times of repeatable discharge. When discharging the battery beyond said range, please consult Panasonic in advance.

Depth of discharge

Depth of discharge is the state of discharge expressed by the ratio of amount of capacity discharged to the rated capacity.

CHARACTERISTICS

STORAGE

Storage condition

Observe the following condition when the battery needs to be stored.

1. Ambient temperature: -15°C to 40°C (preferably below 30°C)
2. Relative humidity: 25 to 85%
3. Storage place free from vibration, dust, direct sunlight, and moisture.

Self-discharge and refresh charge

During storage, batteries gradually lose their capacity due to self-discharge, therefore the capacity after storage is lower than the initial capacity. For the recovery of capacity, repeat charge/discharge several times for the battery in cycle use; for the battery in trickle use, continue charging the battery as loaded in the equipment for 48 to 72 hours.

Refresh charge (auxiliary charge)

When it is unavoidable to store the battery for 3 months or longer, periodically recharge the battery at the intervals recommended in the table below depending on ambient temperature. Avoid storing the battery for more than 12 months.

Storage temperature	Interval of auxiliary charge (refresh charge)
Below 20°C	12 months
20°C to 30°C	9 months
20°C to 40°C	6 months

Residual capacity after storage

The result of testing the residual capacity of the battery which, after fully charged, has been left standing in the open-circuit state for a specific period at a specific ambient temperature is shown in the figure below. The self-discharge rate is very much dependent on the ambient temperature of storage. The higher the ambient temperature, the less the residual capacity after storage for a specific period. Self-discharge rate almost doubles by each 10°C rise of storage temperature figure 4.

Fig. 4 Residual capacity test result

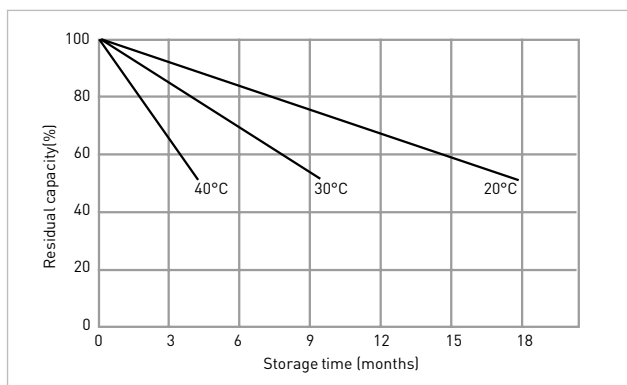

Open circuit voltage vs. residual capacity

Residual capacity of the battery can be roughly estimated by measuring the open circuit voltage as shown in the figure 5.

Fig. 5 Open circuit voltage vs. residual capacity 20°C

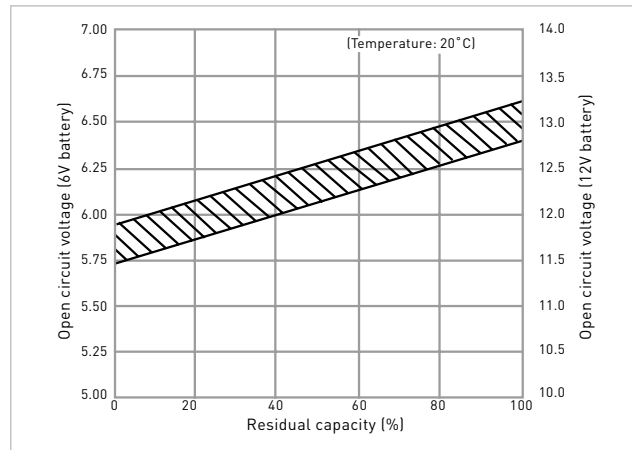

IMPEDANCE

The impedance is an important parameter of batteries. Impedance varies with the state of charge of the battery and temperature as shown on the chart below.

Fig. 6 Relationship between impedance and state of charge

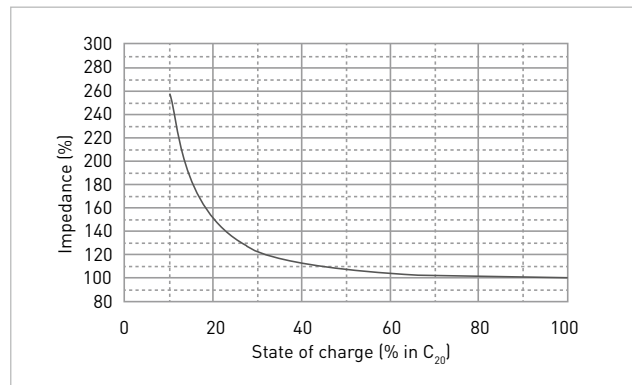
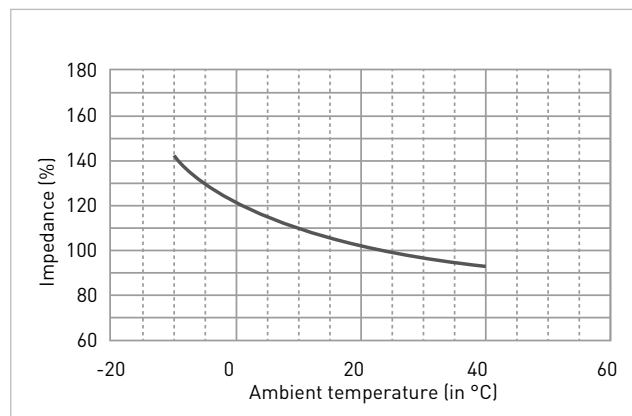

Fig. 7 Relationship between impedance and temperature



TEMPERATURE CONDITIONS

Recommended temperature ranges for charging, discharging and storing the battery are tabulated below.

Charge	0°C ~ 40°C
Discharge	-15°C ~ 50°C
Discharge	-15°C ~ 40°C

BATTERY LIFE

Cycle life

Cycle life (number of cycles) of the battery is dependent on the depth of discharge in each cycle. The deeper the discharge is, the shorter the cycle life (smaller number of cycles), providing the same discharge current. The cycle life (number of cycles) of the battery is also related to such factors as the type of the battery, charge method, ambient temperature, and rest period between charge and discharge. Typical cycle life characteristics of the battery by different charge/discharge conditions are shown by the below figures. This data is typical and tested at a well-equipped laboratory. Cycle times are different for each battery model. Cycle times are also different from this data when using batteries under real conditions.

Fig. 8 Cycle life vs. depth of discharge (cyclic models)

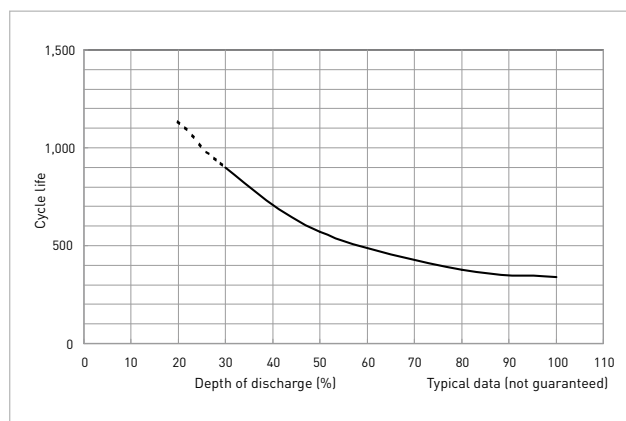

Trickle (float) life

Trickle life of the battery is largely dependent on the temperature condition of the equipment in which the battery is used, and also related to the type of the battery, charge voltage and discharge current. The respective figures show the influence of temperature on trickle life of the battery, an example of trickle (float) life characteristics of the battery, and the test result of the battery life in an emergency lamp.

Fig. 9 Trickle life characteristics at 50°C

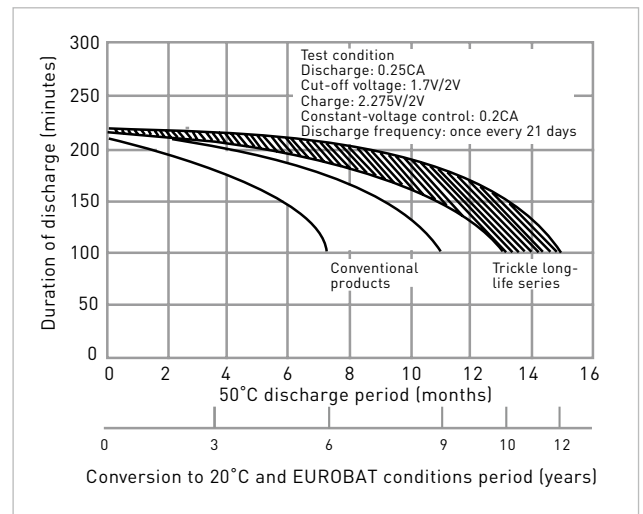
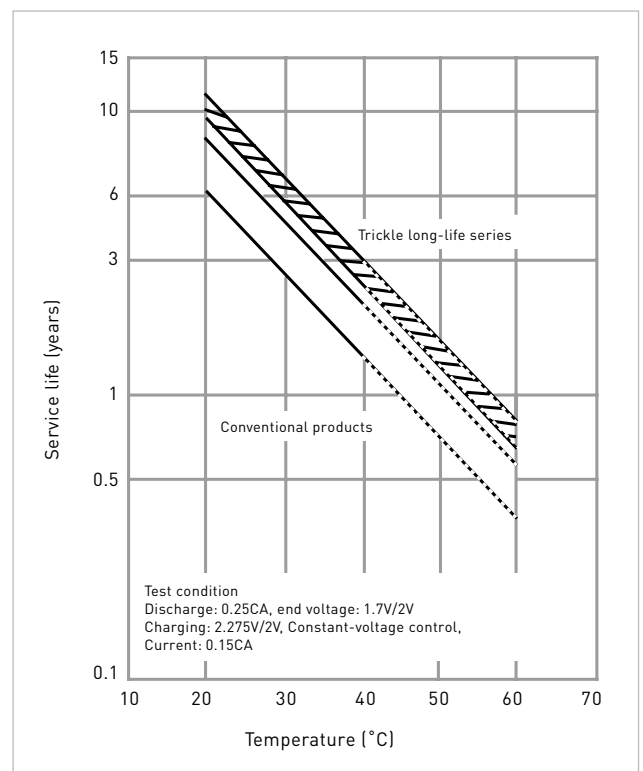

Fig. 10 Influence of temperature on trickle life



Methods of charging the Valve-Regulated-Lead-Acid battery

For charging the Valve-Regulated-Lead-Acid battery, a wellmatched charger should be used because the capacity and life of the battery is influenced by ambient tempera-

ture, charge voltage and other parameters. Charging methods are dependent on battery applications and are roughly classified into main power applications and standby/back-up power applications.

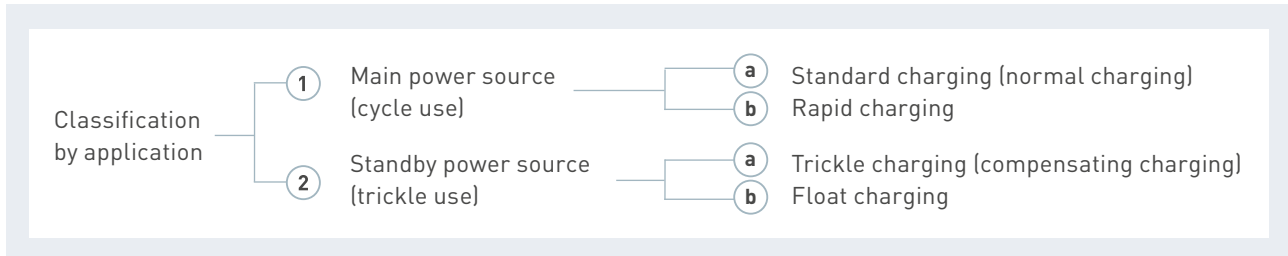

1 Main power source (cycle use)

Cycle use is to use the battery by repeated charging and discharging.

a Standard charging (normal charging)

For common applications of the battery, the constant voltage charge method is advantageous as it allows the battery to exert full performance.

Constant voltage charging method

This method is to charge the battery by applying a constant voltage between the terminals. When the battery is charged by applying a voltage of 2.45V per cell (unit battery) at a room temperature of 20°C to 25°C, charging is complete when the charge current continues to be stable for three hours. Valve-Regulated-Lead-Acid batteries can be overcharged without constant voltage control. When the battery is overcharged, the water in the electrolyte is decomposed by electrolysis to generate more oxygen gas than what can be absorbed by the negative electrode. The electrolyte is changed to oxygen gas and hydrogen gas, and lost from the battery system. As the quantity of electrolyte is reduced, the chemical reactions of charge and discharge become inefficient and hence the battery performance is severely deteriorated. Therefore, exact voltage control and proper charging time in constant voltage charging are essential for securing the expected life of the battery.

Constant voltage and constant-current charging method

This method is to charge the battery by controlling the current at 0.4CA and controlling the voltage at 2.45V/per cell at a room temperature of 20°C to 25°C. Proper charging time is 6 to 12 hours depending on depth of discharge.

Fig. 1 Constant voltage constant-current charge characteristics

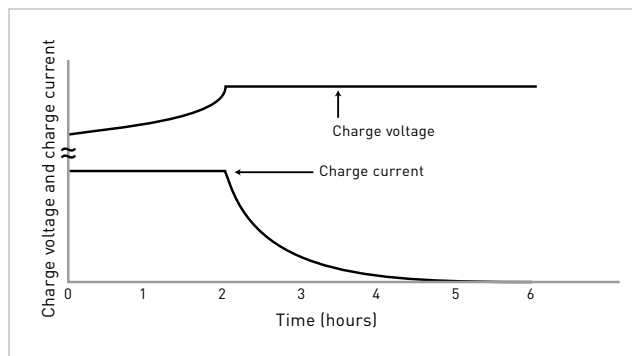

b Rapid charging

When rapidly charging the battery, a large charge current is required in a short time for replenishing the energy which has been discharged. Therefore, some adequate measures such as the control of charge current is required to prevent overcharging when the rapid charging is complete. Basic requirements for rapid charging are as follows:

- Sufficient charging should be made in a short time for fully replenishing the amount discharged.
- Charge current should be automatically controlled to avoid overcharge even on prolonged charging.
- The battery should be charged adequately in the ambient temperature range of 0°C to 40°C.
- Reasonable cycle life of charge/discharge should be secured. Typical methods to control charging so as to satisfy the above requirements follow.

Two-step constant voltage charge control method

Two-step constant voltage charge control method uses two constant-voltage devices. At the initial stage, the battery is charged by the first constant-voltage device SW(1) of high set-up voltage (set-up for cycle charge voltage). When the charge current has reduced to the preset value, the device is switched over to the second SW(2) of low set-up voltage (set-up for trickle charge voltage). This method has the advantage that the battery

in trickle use can be charged in a comparatively short time for the next discharge.

Fig. 2 Charging characteristics of the two-step constant voltage control charger

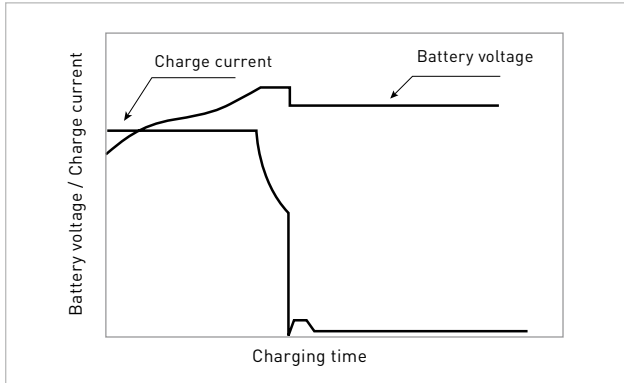
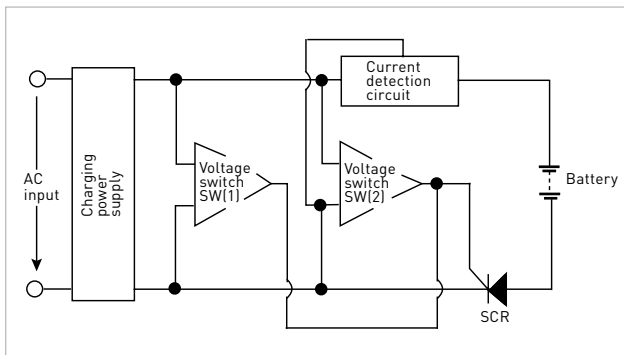

Fig. 3 Diagram of the two-step constant voltage control charger



2 Standby/back-up use (trickle use)

The application load is supplied with power from AC sources in normal state. Standby/back-up use is to maintain the battery system at all times so that it can supply power to the load in case the AC input is disrupted (such as a power failure). There are two methods of charging for this use.

a Trickle charging (compensating charging)

In this charge system, the battery is disconnected from the load and kept charged with a small current only for compensating self-discharge while AC power is alive. In case of power failure, the battery is automatically connected to the load and battery power is supplied. This system is applied mainly as a spare power source for emergency equipment. In this use, if rapid recovery of the battery after discharge is required, it is necessary to consider the recovery charge with a comparatively large current followed by trickle charge, or alternative measures. While the type and capacity of the battery is determined by the back-up time and the load (current consumption) during power failure, some reserve power should be taken into account considering such factors as ambient temperature, capability of the charger and depth of discharge.

Fig. 4 Trickle charge system model

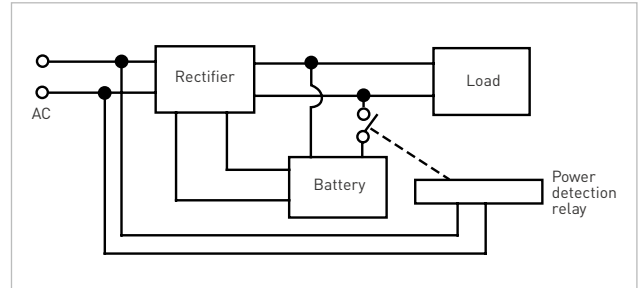

b Float charging

Float system is the system in which the battery and the load are connected in parallel to the rectifier, which should supply a constant power.

Fig. 5 Float charge system model

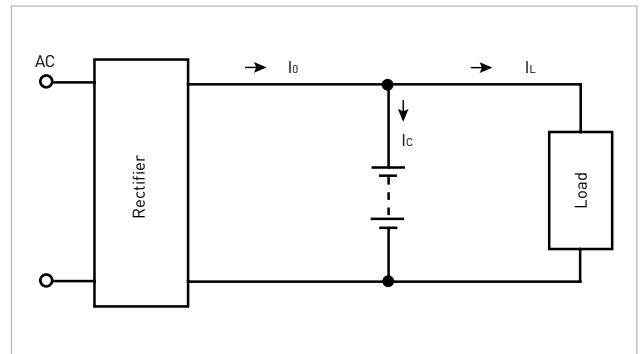

In the above-illustrated model, output current of the rectifier is expressed as: $I_0 = I_c + I_L$ where I_c is charge current and I_L is load current. Consideration should be given to secure adequate charging because, in fact, load current is not constant but irregular in most cases.

In the float system, capacity of the constant-voltage power source should be more than sufficient against the load. Usually, the rectifier capacity is set at the sum of the normal load current plus the current needed in order to charge the battery.

Precautions on charging

1. As the battery continues to be charged over a long period, a small difference in charging voltage may result in a significant difference in the battery life. Therefore, charge voltage should be controlled within a narrow range and with little variation for a long period.
2. As charge characteristics of the battery are dependent on temperature, compensation for temperature variation is required when the battery is used over a broad temperature range, and the system should be designed so that the battery and the charger are kept at the same temperature.

CHARGING METHODS

CHARGING METHODS AND APPLICATIONS OF VRLA BATTERIES

Application / charging method	Normal charging in 6 or more hours; constant voltage control	Two-step constant voltage control	Constant current control
Cycle Use	Control voltage: 7.25 to 7.45V/6V battery 14.5 to 14.9V/12V battery Initial current: 0.4 CA or smaller		
Trickle use	Control voltage: 6.8 to 6.9/6V battery 13.6 to 13.8V/12V battery	Initial charging with current of approx. 0.15CA, followed by switching voltage to trickle charge	
Float use	Control voltage: 6.8 to 6.9/6V battery; 13.6 to 13.8V/12V battery. Float charging compensates for load fluctuations.		
Refresh charge (auxiliary charge)*1	When charging two or more batteries at a time, select only those which have been left under the same condition.		Charging with current of approx. 0.1CA
Application example	General uses, cellular phones (bag phones), UPS, lanterns, electric tools	Medical equipment, personal radios	

Precautions on charging

- (a) In constant voltage charging (cycle use): Initial current should be 0.4CA or smaller (C: rated capacity)
- (b) In constant voltage charging (trickle use): Initial current should be 0.15CA or smaller (C: rated capacity).
- Relation between standard voltage value in constant voltage charging and temperature is given in the table.

Relation between standard voltage value in constant voltage charging and temperature

		0°C	20°C	40°C
Cycle use	6V	7.7	7.4	7.1
	12V	15.4	14.7	14.2
Trickle use	6V	7.1	6.8	6.7
	12V	14.1	13.7	13.4

Temperature compensation of charge voltage

Charge voltage should be compensated to the ambient temperature near the battery, as shown by the figure below. Main reasons for the temperature compensation of charge voltage are to prevent the thermal runaway of the battery when it is used in high temperature conditions and to secure sufficient charging of the battery when it is used in low temperature conditions. Prolongation of service life of the battery by the above-described temperature compensation is expected as follows:

- At 30°C: prolonged by approx. 5%
- At 35°C: prolonged by approx. 10%
- At 40°C: prolonged by approx. 15%

In low temperature zones below 20°C, no substantial prolongation of the battery life can be expected by the temperature compensation of charge voltage.

Charging time

Time required to complete charging depends on factors such as depth of discharge of the battery, characteris-

tics of the charger and ambient temperature. For cycle charge, charging time can be estimated as follows:

- If the discharge current was 0.25CA or greater:
 $T_{ch} = C_{dis} / I + (3h \text{ to } 5h)$
- If the discharge current was below 0.25CA:
 $T_{ch} = C_{dis} / I + (6h \text{ to } 10h)$, where
Tch: Charging time required (hours)
Cdis: Amount of discharge before this charging (Ah)
I: Initial charge current (A)

Charging temperature

- Charge the battery at an ambient temperature in the range from 0°C to 40°C.
- Optimum temperature range for charging is 5°C to 35°C.
- Charging at 0°C or below and 40°C or higher is not recommended: at low temperatures, the battery may not be charged adequately; at high temperatures, the battery may become deformed.
- For temperature compensation values, see table 'Relation between standard ...' in the left column.

Fig. 6 Compensated voltage value

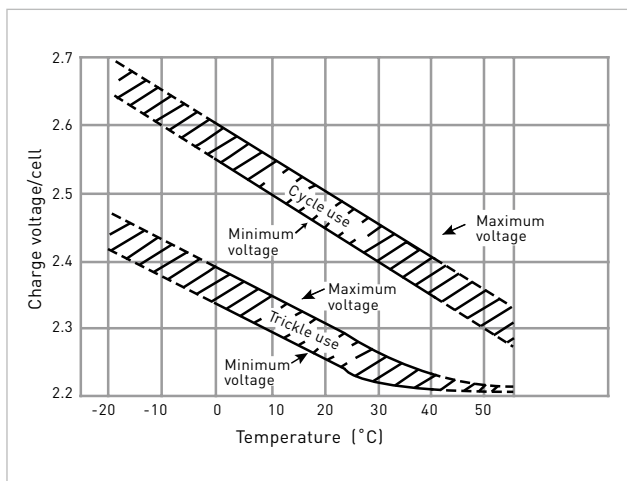

Reverse charging

Never charge the battery in reverse, as it may cause leakage, heating or bursting of the battery.

Overcharging

Overcharge is an additional charge after the battery is fully charged. Continued overcharging shortens the battery life. Select a charge method which is specified or approved for each application.

Charging before use

Recharge the battery before use to compensate for capacity loss due to self-discharge during storage. See 'Refresh charge (auxiliary charge)' table on page 18.

Characteristics of constant voltage chargers

Even with the same voltage set-up, charging time varies with output V-I characteristics.

Precautions

1. When adopting charging methods and charging conditions other than those described in the specifications or the brochures, thoroughly check charging/discharging characteristics and life characteristics of the battery in advance. Selection of appropriate methods and conditions of charging is essential for safe use of the battery and for fully utilizing its discharge characteristics.
2. In cyclic use of the battery, use a charger equipped with a charging timer or a charger in which charging time or charge amount is controlled by other means; otherwise, it will be difficult to judge the completion of the charge. Use of a charger as described above is recommended to prevent undercharge or overcharge which may cause deterioration of the battery characteristics.
3. Continue charging the battery for the specified time or until the charge completion lamp, if equipped, indicates completion of charging. Interruption of charging may cause a shortening of service life.
4. Do not recharge the fully charged battery repeatedly, as overcharge may accelerate deterioration of the battery.

Fig. 7 Output V-I characteristics of the constant voltage charger vs. charging pattern of the battery

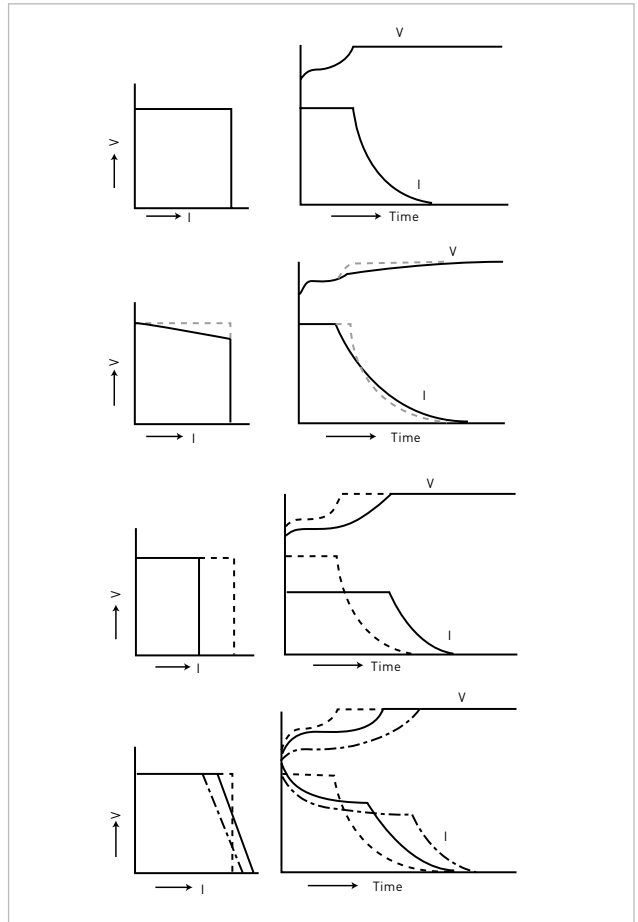

5. In cyclic use of the battery, do not continue charging for 24 hours or longer, as it may accelerate deterioration of the battery.
6. In cyclic service of the battery, avoid charging two or more batteries connected in parallel simultaneously; imbalance of charge/discharge amount among the batteries may shorten the life of batteries.

Fig. 8 Example of constant voltage charger circuitry (concept diagram)

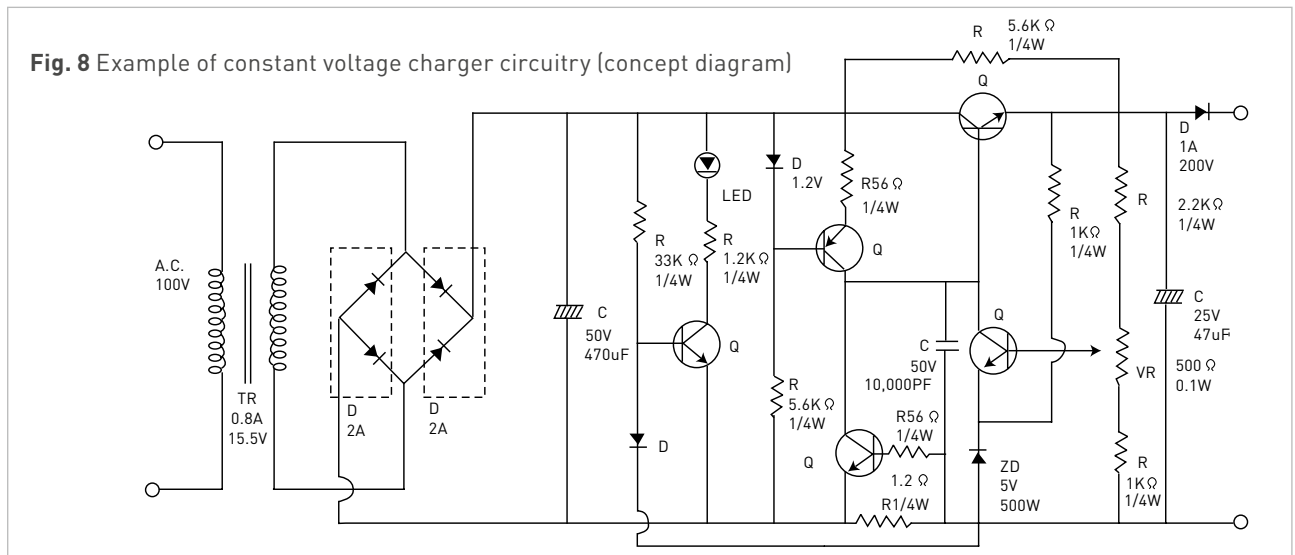

TERMINAL DATA

BOLT AND NUT TYPE

L-shape terminal (M5, M6, M8)

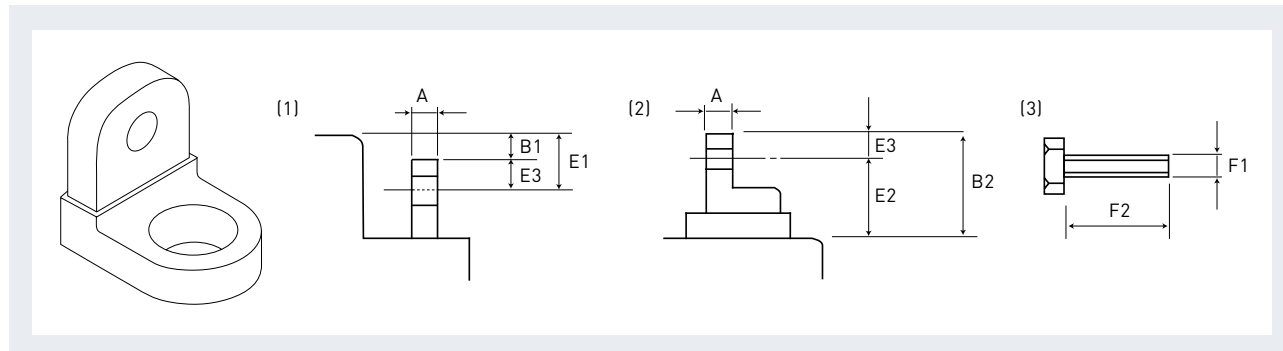

Type of terminal	Terminal thickness A (1)	Height from battery case top		Terminal width	Hole diameter	Hole position			Bolt		
		B1 (1)	B2 (2)			Distance from top E1 (1)	Distance from top E2 (2)	Distance from terminal top E3 (2)	Diameter F1 (3)	Pitch	Length F2 (3)
M5 bolt and nut	5.0 ± 0.3	1.0	-	11 ± 0.4	5.5 ± 0.3	6.5	-	5.5 ± 0.3	M5	P = 0.8	15 ± 1.0
M6 bolt and nut	8.0 ± 0.5	5.0	16.5 ± 1.5	16 ± 0.8	6.5 ± 0.4	-	9 ± 1.0	7.5 ± 0.4	M6	P = 1.0	20 ± 1.0
M8 bolt and nut	8.0 ± 0.5	-	24 ± 1.5	-	6.5 ± 0.4	-	14 ± 1.0	10 ± 0.4	M8	P = 1.25	20 ± 1.0

All dimensions in mm.

TERMINAL MATERIAL

Bolt & nut: Lead Alloy

(Proposition 65 Warning: Battery posts, terminals and related accessories contain lead and lead compounds, and handling this product may also expose you to Sulfuric acid mist, chemicals known to the State of California to cause cancer and reproductive harm. Wash hands after handling.)

Fasten 187: Tin plated brass

Fasten 250: Tin plated brass

Threaded: Tin plated steel

all other: lead

T-shape terminal (M10)

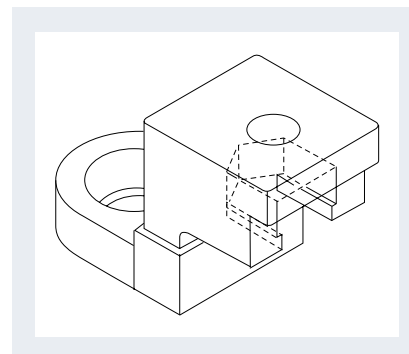

Fasten tab type 187

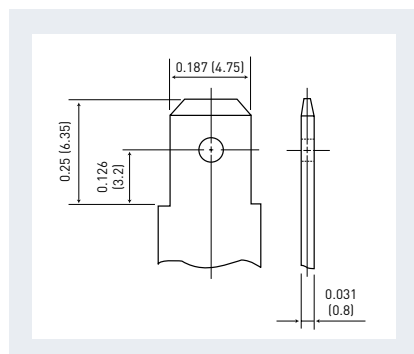

Fasten tab type 250

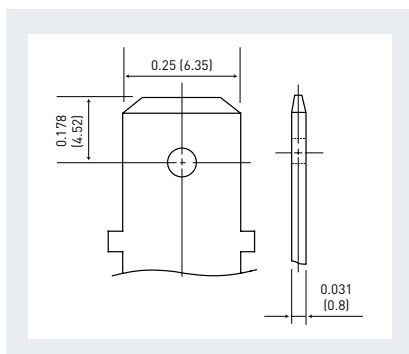

M5 threaded post type

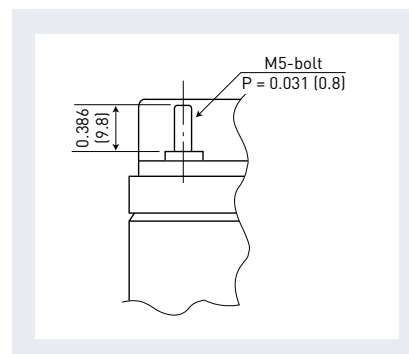

Unit: inch (mm)

VRLA battery safety test items

Item	Test method	Check point
1. Shock test (drop test) IEC 61056-1 and JIS C 8702 (These specifications are harmonized each other)	A fully charged battery is allowed to drop in the upright position from the height of 20cm onto a hard board having a thickness of 10mm or more. Test is repeated three times.	The battery should be free from noticeable breakage or leaks; and its terminal voltage should be held higher than the nominal voltage.
2. Vibration test IEC 61056-1 and JIS C 8702 (These specifications are harmonized each other)	A vibration frequency 1,000 times/minute and amplitude 4mm (equals 2.2g of force) is applied to the X-, Y- and Z-axis directions of a fully charged battery for 60 minutes respectively.	No battery part should be broken; the battery should be free from leaks; and its terminal voltage should be held higher than the nominal voltage.
3. Oven test Panasonic internal standard	A fully charged battery is left standing in an atmosphere of 70°C for 10 hours.	The battery case should not be deformed; the battery should be free from leaks.
4. Coldproof test Panasonic internal standard	A fully charged battery is connected to a resistor equivalent to 60 hours rate discharge and left for 4 days; then the battery is left standing in an atmosphere of -30°C for 24 hours.	No crack should develop in the battery case; the battery should be free from leaks.
5. Heat cycle test Panasonic internal standard	A fully charged battery is exposed to 10 cycles of 2 hours at -40°C and 2 hours at 65°C.	No crack should develop in the battery case; the battery should be free from leaks.
6. Short circuit test Panasonic internal standard	A fully charged battery connected with a small resistor of 10 ohms or less is allowed to discharge.	The battery must not burn nor bust.
7. Large current discharge test Panasonic internal standard	A fully charged battery is allowed to discharge at 3CA to 4.8V/6V battery level. (This test is not applicable to batteries having built-in thermostat.)	The battery should not burn or bust, and it should be free from battery case deformation, leaks and any irregularity internal connections.
8. Vent valve function test UL1989	A fully charged battery is submerged in liquid paraffin in a container, then overcharged at 0.4CA. (UL1989)	Release of gas from the vent should be observed.
9. Overcharge test Panasonic internal standard	A fully charged battery is overcharged at 0.1CA for 48 hours, left standing for one hour, and allowed to discharge at 0.05CA to 5.25V/6V.	No irregularity should be noticed in the battery appearance; the battery should retain 95% or more of the initial capacity.

SAFETY DESIGN

Vent (one way valve)

If the internal pressure of the battery is raised to an abnormal level, the rubber one way valve opens to release excessive pressure; thus the valve protects the battery from danger of bursting. Since the rubber valve is instantly resealable, the valve can perform its function repeatedly whenever required.

Fig. 1 Example of valve construction

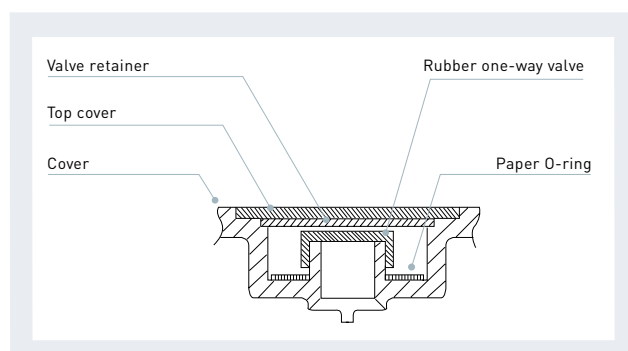

VRLA batteries are inherently safe. However, there are some risks when VRLAs are used beyond a reasonable replacement time span, misapplied or abused. There are two main failure mode of VRLA battery used for trickle (float) application. In high temperatures and/or high voltage charging, dry-out is accelerated. This leads to loss of capacity and eventually the cell will fail open. Grid growth due to grid corrosion causes loss in mechanical strength and eventually leads to loss of contact with the grid. Battery should be replaced before these failures.

If VRLA batteries are used after the end of life, the grid growth may cause a crack of container. Capillary action can result in a slight film of conductive electrolyte forming around the crack even though VRLA batteries contain significantly lower volumes of electrolyte and the electrolyte is immobilized. This electrolyte film will be in contact with an uninsulated metal component and this ground fault current could result in thermal runaway of a portion of the string or even a fire. And the grid growth may cause internal short between positive grid and negative strap in a cell. Continuing to charge a string of cells when one or more of the cells exhibit internal shorts,

can result in thermal runaway. For example, assume a string of 12 cells is being charged at 27.3V (2.275V/cell) and the string continues in operation with two cells shorted. In this situation the average charging voltage on the remaining 10 good cells is 2.73V/cell. This will result in very high float current and cause thermal runaway. Figure 2 is the mechanism of above phenomena.

Panasonic VRLA battery minimizes these risks by using less corrosive lead alloy and expanded positive grid. Figure 3 shows an example of cast grid and expanded grid. Expanded grid does not have enough strength to crack container case by grid growth. And an insulator between positive grid and negative strap is installed in the models as necessary.

Furthermore, Panasonic uses flame-retardant battery container case for the models used for standby application. The cases are designed to be self-extinguishing and meet minimum flammability standards of UL94 V-0 and 28 L.O.I. (Limiting Oxygen Index). Figure 4 is the picture of self-extinguishing phenomenon.

Fig. 2 Mechanism of thermal runaway caused by grid growth

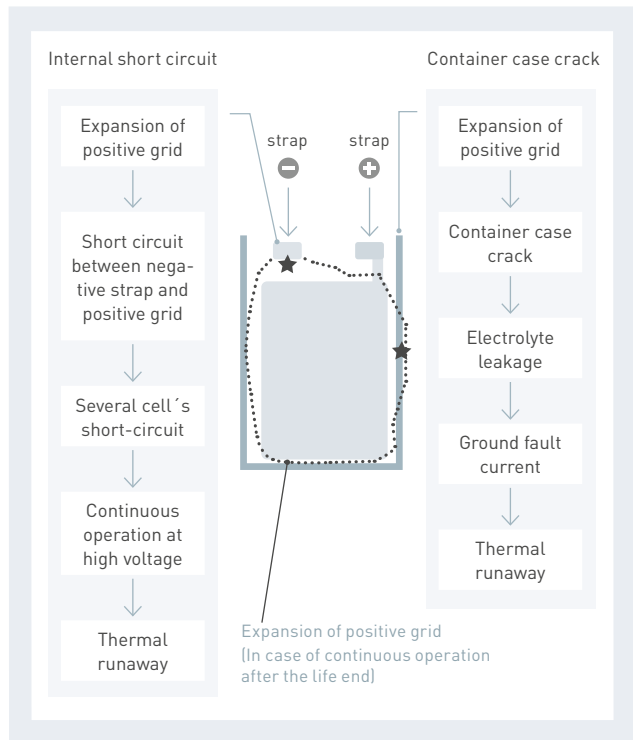

Fig. 3 Cast grid and expanded grid

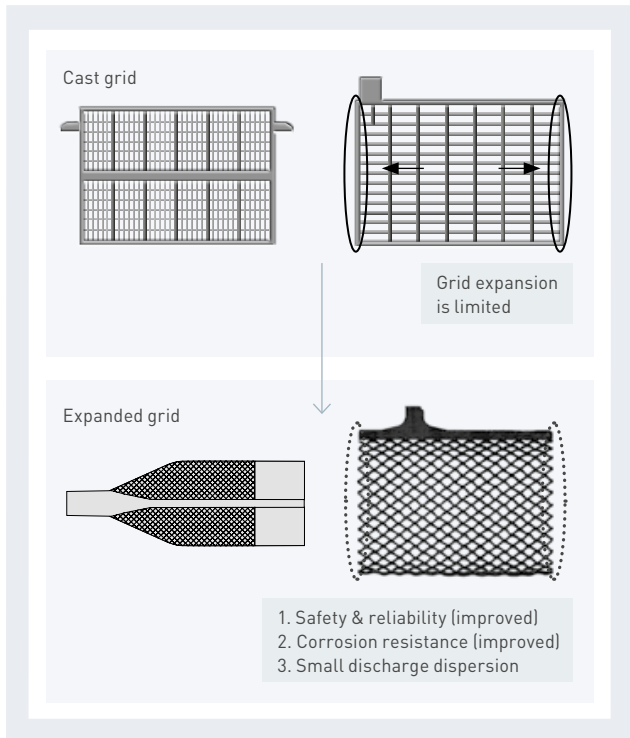
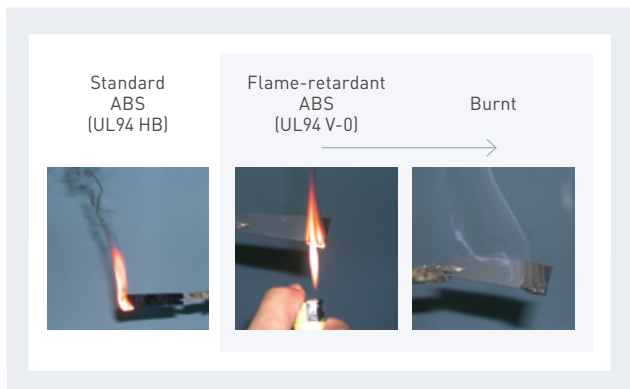

Fig. 4 Flame-retardant case (self-extinguish phenomenon)



INDEX

- 1 Lotcode (internal)
- 2 Datecode (format YYMMDD + shift indication letter)
- 3 Brand name
- 4 Type of battery
- 5 Model number
- 6 Rated voltage & capacity
- 7 Flame-retardant ABS (UL94 V-0) mark
- 8 Charging recommendation
- 9 Recycling mark (US)
- 10 Caution
- 11 Manufacturer name & country of origin
- 12 China RoHS markings
- 13 VdS marking
- 14 Recognized component mark (UL mark)
- 15 Recycling mark (JP)
- 16 Recycling mark (EU)



MODEL NUMBERS OF VRLA BATTERIES

COMPOSITION OF MODEL NUMBERS LC-SERIES

Figure No.	1	2	3	4	5	6	7	8	9	10	11	12	13
Model No.	L	C	-	⊗	⊗	⊗	⊗	⊗	⊗	⊗	⊗	⊗	⊗

No. 1 to 3

Product division codes (all of which are assigned by Panasonic). 'LC' means Panasonic Valve-Regulated-Lead-Acid batteries.

No. 4

Fixed single-figure code (alphabetic letter) indicating properties, shape, etc. of the battery.

- C: Cycle long-life products**
- P: Products combining trickle long-life and flame-retardant battery case**
- Q: Trickle super long-life products**
- R: Small-sized common products (under 17Ah)**
- T: Cycle long-life products for energy storage**
- V: Products of 'R' types with flame-retardant battery case (option)**
- X: Trickle long-life products**

No. 5

Single code (alphabetic letter) for dividing products of the same type and the same capacity but having different properties. (This figure may be omitted when not applicable, then the proceeding codes are advanced).

Examples: A, B, C, D, N

No. 6 to 7

Double-figure fixed codes indicating nominal voltage by numerical value.

Examples: 6V = 06, 12V = 12

No. 8 to 10

One to three digit alphanumeric code indicating capacity by numbers: decimal point is expressed by R (when some codes are not applicable, the proceeding codes are advanced).

Examples:

Capacity (20 hours rate)	4Ah	7.2Ah	12Ah	100Ah
Model number	4	7R2	12	100

No. 11 to 13

One to three digit alphanumeric code for classifying products by terminal type and label design.

- Examples: 1: Faston 250**
A: Threaded posts
G: VdS certified product
J: Japanese label
P: English label

Note: Country codes are subject to change.

Model number (example)

LC - RA 1 2 1 2 PG 1

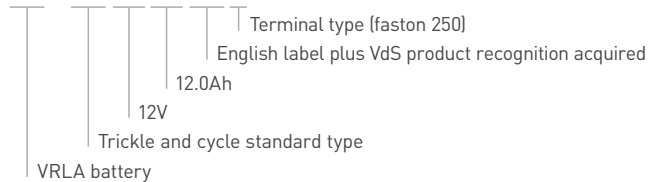

LC - XD 1 2 1 7 AP G

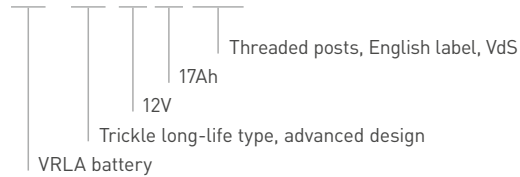

LC - X 1 2 6 5 PG

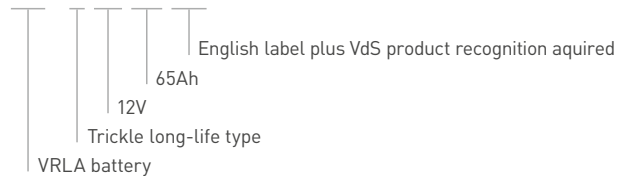

COMPOSITION OF MODEL NUMBERS UP-*W SERIES (HIGH POWER BATTERIES FOR UPS)

Figure No.	1	2	3	4	5	6	7	8	9	10	11	12
Model No.	U	P	-	◇	W	◇	◇	◇	◇	◇	◇	◇

No. 1 to 3
Production division codes of high power batteries for UPS.

No. 4
Alphanumeric code indicates properties, shape, etc. of the battery.

- R:** High power series with standard HB container
- P:** High power and long-life series with flame-retardant container
- V:** High power series with flame-retardant container

No. 5
Indication of wattage.

No. 6
Single alphabetic letter for dividing products of the same type and the same capacity but having different shapes. (This figure may be omitted when not applicable, then the proceeding codes are advanced.)

Example: A

No. 7 to 8
Double-figure fixed codes indicating nominal voltage by numerical value.

Examples: 12V = 12, 6V = 06

No. 9 to 10
Indicating wattage, 10 minute rate discharge.

No. 11 to 12
One-through five-figure (maximum) alphanumeric code for classifying products by terminal type, package form, destination code, etc.

- Examples: J:** Japanese label
- P:** English label
- 1:** Faston 250
- 2:** Faston 250 & faston 187

Note: The last numbers of model number changes depending on the country of destination. Please consult Panasonic for more details. Division codes are subject to change.

Model number (example)

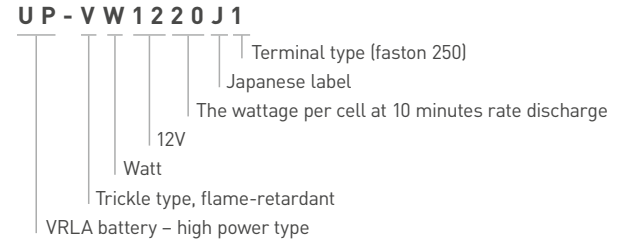
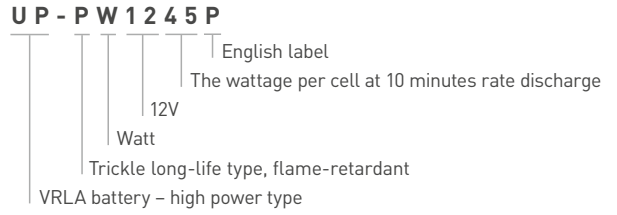

PRODUCT CERTIFICATIONS

Alarm security market / VdS approved batteries

Model number	Nominal voltage (V)	Rated capacity (Ah)	 VdS N°	Country of origin
LC-R121R3PG / LC-V121R3PG	12	1.3	G196049	China
LC-R122R2PG / LC-V122R2PG	12	2.2	G188151	China
LC-R123R4PG / LC-V123R4PG	12	3.4	G191053	China
LC-R127R2PG / LC-V127R2PG	12	7.2	G193046	China
LC-RA1212PG / LC-VA1212PG	12	12.0	G100001	China
LC-XD1217PG/APG / LC-PD1217PG/APG	12	17.0	G104101	China
LC-P1224PG/APG	12	24.0	G198049	China
LC-P1238PG/APG	12	38.0	G100002	China
LC-X1265PG / LC-P1265PG	12	65.0	G199090	China

UL approved batteries

All our VRLA batteries are in compliance with UL 1989 (standby batteries) – file number MH 13723. UL 1989 requires that the battery is free from the hazard of bursting, that is, when the battery is overcharged the vent valve opens to release internal pressure.

FACTORY CERTIFICATIONS

ISO 9001 / ISO 14001

Quality management system (ISO 9001) defines what the organization does to ensure that its products or services satisfy the customer's quality requirements and comply with any regulations applicable to those products or services. ISO 14001 is primarily concerned with 'environmental management'. In plain language, this means what the organization does to minimize harmful effects on the environment caused by its activities.

OHSAS 18001

OHSAS 18001 is an Occupation Health and Safety Assessment Series for health and safety management systems. It is intended to help organizations to control occupational health and safety risks. It was developed in response to widespread demand for a recognized standard against which to be certified and assessed.

APPLICABLE STANDARDS

Following documents are established by consensus and approved by a recognized body, that provides, for common and repeated use, rules, guidelines or characteristics for activities or their results, aimed at the achievement of the optimum degree of order in a given context.

Note: Standards should be based on the consolidated results of science, technology and experience, and aimed at the promotion of optimum community benefits. IEC standards cover a vast range of technologies from power generation, transmission and distribution to home appliances and office equipment, semiconductors, fibre optics, batteries, solar energy, nanotechnology and marine energy as well as many others. IEC standards are also being adopted as harmonized standards by other certifying bodies such as BSI (Great Britain), CSA (Canada), UL & ANSI/INCITS (USA), SABS (South Africa), SAI (Australia), SPC/GB (China), DIN (Germany) and JIS (Japan). IEC standards harmonized by other certifying bodies generally have some noted differences from the original IEC standard.

JIS (Japan Industrial Standard)

All our VRLA batteries are in compliance with JIS C 8702 (almost harmonized with IEC 61056).

IEC 61056

Specifies the general requirements, functional characteristics and methods of test for all general purpose lead acid cells and batteries of the valve regulated type for either cyclic or float charge application; in portable equipment, for instance, incorporated in tools, toys, or in static emergency, or uninterruptible power supply and general power supplies.

The cells of this kind of lead acid battery may either have flat-plate electrodes in prismatic containers or have spirally wound pairs of electrodes in cylindrical containers. The sulfuric acid in these cells is immobilized between the electrodes either by absorption in a microporous structure or in a gelled form.

IEC 61056-1

General purpose lead acid batteries (Valve-Regulated types) - part 1: general requirements, functional characteristics - methods of test

IEC 61056-2

General purpose lead acid batteries (Valve-Regulated types) - part 2: dimensions, terminals and marking

IEC 60896-21

Stationary lead acid batteries - part 21: Valve-Regulated types - methods of test

This part of IEC 60896 applies to all stationary lead acid cell and monobloc batteries of the Valve-Regulated type for float charge applications, (i.e. permanently connected to a load and to a d.c. power supply), in a static location, (i.e. not generally intended to be moved from place to place) and incorporated into stationary equipment or installed in battery rooms for use in telecom uninterruptible power supply (UPS), utility switching, emergency power, or similar applications.

IEC 60896-22

Stationary lead acid batteries - part 22: Valve-Regulated types - requirements

Same as above, but defining the requirements.

Following standards are adopted as harmonized standards.

EN 50272-2 (DIN VDE 0510 part 2)

Safety requirements for secondary batteries and battery installations. Safety requirements for batteries and battery systems-stationary batteries. The ventilation requirements for safety rooms are specified herein. Apply the VRLA formula together with our batteries.

UN2800 Transport regulations

All Panasonic VRLA batteries listed in this handbook comply with ADR/IMDG SP 238 (road/sea) and IATA SP A67 and PI 806 (air). These batteries have to be handled as non-dangerous goods (non-spillable).

BATTERY SELECTION

STEPS FOR SELECTING BATTERIES ARE DESCRIBED BELOW

Study of required specifications (draft)

Study the required specifications (draft) by checking the requirements for the battery with the battery selection criteria. Technical requirements for selecting the battery are presented below.

Battery selection

First, select several candidate batteries by referring to the technical brochures and data sheets of the batteries presently available. Then from the candidates select a battery which can meet as many of the ideal requirements as possible. In fact, however, battery selection can be seldom made so smoothly. Practically, possible removal or easing of the requirements should be considered first; then depending on the result, a proper battery should be selected from those presently available. This way of proceeding

enables economic selection of the battery. Any questions at this stage should be asked to battery engineers in depth. Sometimes, new or improved batteries which are not carried in the brochures have become available, and an appropriate battery may be found among them. Usually, required specifications are finalized at this stage.

Request for improving or developing batteries

If no battery which will satisfy special requirements can be found by the approach described above, requests for improving or developing new batteries should be made to our technical department, and these requests should be coordinated as quickly as possible to allow enough time for studying: the study takes usually 6 to 12 months or even longer depending on the request. In this section, guidelines for selecting appropriate batteries for specific equipment were mentioned. If further information regarding the battery selection is required, please contact us.

TECHNICAL REQUIREMENTS FOR BATTERY SELECTION

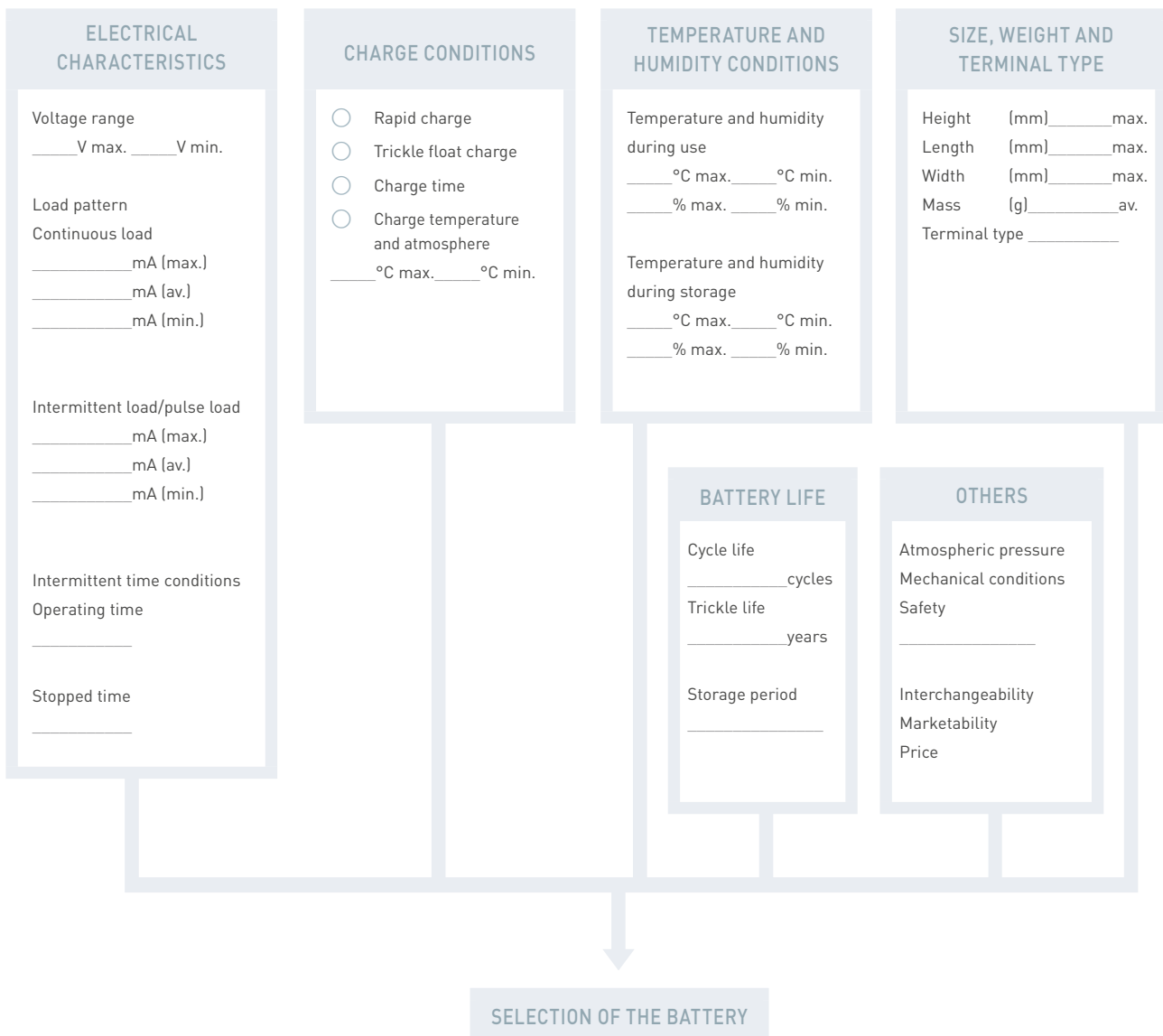

BATTERY TYPES AND MODEL NUMBERS

Application	Series	Trickle design life (at 20°C)	Category	Standard ABS (UL94 HB)	FR ABS = Flame-retardant ABS (UL94 V-0)
Back-up and main power	LC-R/RA	6 – 9 years	Trickle and cycle standard type	○	
Back-up	LC-P/PA/PB/PD	10 – 12 years	Trickle long-life type		○
	LC-QA	15 years	Trickle super long-life type		○
	LC-V/VA	6 – 9 years	Trickle standard type		○
	LC-X/XB/XD	10 – 12 years	Trickle long-life type	○	
	UP-PW	10 – 12 years	High power long-life type		○
	UP-VW/VWA	6 – 9 years	High power type		○
Main power	LC-CA/XC	-	Cycle long-life type	○	
	LC-T	-	Cycle long-life type for energy storage	○	
Motive and hybrid	EC-FV/HV	-	Cycle long-life type for motive power	*1	*1



LC SERIES

The Panasonic LC series is a comprehensive range of high quality VRLA batteries serving the majority of VRLA battery applications. From batteries with a trickle design life of 6 – 9 years and 10 – 12 years to batteries of 15 years, the series includes solutions for every requirement. Various models are obtainable with flame-retardant housing and with different terminals.

FEATURES

- State-of-the-art Absorbed Glass Mat (AGM) technology
- Superior design and low voltage spread
- Enhanced lifespan due to excellent recombination efficiency
- Highest quality control standards
- Almost 50 years of experience in production
- Selected batteries with flame-retardant battery containers according to UL94 V-0
- Various VdS approved batteries

APPLICATIONS

- UPS
- Energy storage
- Communication infrastructure
- Wind turbines (pitch system)
- Alarm systems
- Medical equipment
- Emergency lights, etc.

LC SERIES – TRICKLE DESIGN LIFE 6 – 9 YEARS

MODEL NUMBER (EXAMPLE)

LC - R 1 2 1 R 3 P G

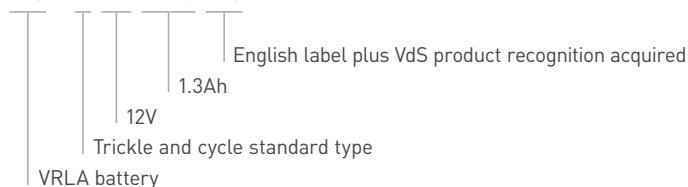

LC - RA 1 2 1 2 P G 1

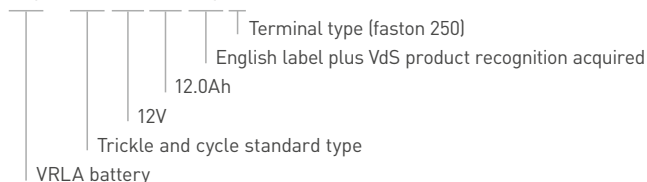

*1 Polypropylene

Model number	Nominal voltage (V)	Nominal capacity (Ah) 20 hours rate	Length (mm)	Width (mm)	Total height (mm)	Weight (kg)	VdS number	Page
LC-R061R3P*1	6	1.3	24	97	55	0.25	-	38
LC-R063R4P*1	6	3.4	34	134	66	0.60	-	40
LC-R064R5P*1	6	4.5	48	70	108	0.70	-	42
LC-R067R2P/P1*1	6	7.2	34	151	100	1.30	-	44
LC-R0612P/P1*1	6	12.0	50	151	100	1.95	-	46
LC-R121R3PG*1	12	1.3	47.5	97	55	0.55	G196049	48
LC-R122R2PG*1	12	2.2	34	177	66	0.80	G188151	50
LC-R123R4PG*1	12	3.4	67	134	66	1.15	G191053	52
LC-R124R5P*1	12	4.5	70	97	108	1.45	-	54
LC-R127R2PG/PG1*1	12	7.2	64.5	151	100	2.50	G193046	56
LC-RA1212PG/PG1*1	12	12.0	98	151	100	3.80	G100001	58
LC-RA1215P/P1*1	12	15.0	98	151	100	4.15	-	60
LC-V1233P	12	33.0	130	195.6	180	11.5	-	62

LC SERIES – TRICKLE DESIGN LIFE 10–12 YEARS

MODEL NUMBER (EXAMPLE)

LC - X D 1 2 1 7 A P G

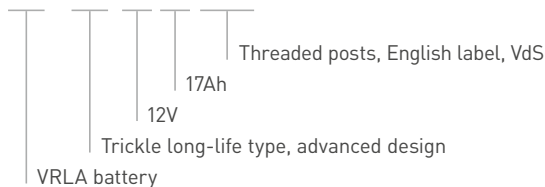

LC - X 1 2 6 5 P G

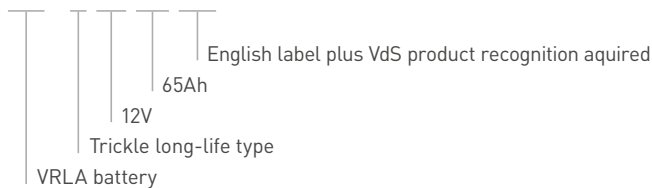

Model number	Nominal voltage (V)	Nominal capacity (Ah) 20 hours rate	Length (mm)	Width (mm)	Total height (mm)	Weight (kg)	VdS number	Page
LC-P067R2P/P1	6	7.2	34	151	100	1.30	-	64
LC-P0612P/P1	6	12.0	50	151	100	2.00	-	66
LC-P06200TA	6	200	173	407	250	33.5	-	68
LC-P122R2P	12	2.2	34	177	66	0.80	-	70
LC-P123R4P	12	3.4	67	134	66	1.15	-	72
LC-P127R2P/P1	12	7.2	64.5	151	100	2.30	-	74
LC-PA1212P/P1	12	12.0	98	151	100	3.65	-	76
LC-PA1216P/P1	12	16.0	98	151	105	4.10	-	78
LC-XD1217PG/APG*1	12	17.0	76	181	167	5.90	G104101	80
LC-P1220P/AP	12	20.0	76	181	167	5.90	-	82
LC-P1224PG/APG	12	24.0	125	165	179.5/175	8.05	G198049	84

*1 This battery is also available with a flame-retardant battery case resin (UL94 V-0).

Model number	Nominal voltage (V)	Nominal capacity (Ah) 20 hours rate	Length (mm)	Width (mm)	Total height (mm)	Weight (kg)	VdS number	Page
LC-P1228P/AP	12	28.0	125	165	179.5/175	9.40	-	86
LC-P1238PG/APG	12	38.0	165	197	180/175	12.5	G100002	88
LC-P1242P/AP	12	42.0	165	197	180/175	13.5	-	90
LC-X1265PG*1	12	65	166	350	175	23.5	G199090	92
LC-P1275P	12	75	166	350	175	21.5	-	94
LC-XB12100P*1	12	100	173	407	236	36.5	-	96
LC-P12120P	12	120	173	407	236	34.5	-	98
LC-P12150BP*2	12	150	183	532	214	43.0	-	100
LC-P12200BP*2	12	200	237	533	216	57.0	-	102



LC-QA SERIES – TRICKLE DESIGN LIFE 15 YEARS

The hallmarks of the Panasonic LC-QA battery series are a very long service life of 15 years (at 20°C) and excellent product quality. The latest LC-QA models are the result of a research programme to prolong the service life of lead acid batteries, which Panasonic started back in 1984.

FEATURES

- Innovative lead-calcium-tin alloy minimises harmful corrosion to the positive electrode
- Reliable seal thanks to a rubber washer and epoxy resin
- Flame-retardant housing according to UL 94-V0

APPLICATIONS

- Mainly telecommunications industry
- Emergency light for trains
- UPS systems
- Energy distribution, etc.

MODEL NUMBER (EXAMPLE)

LC - QA 1 2 2 4 A P

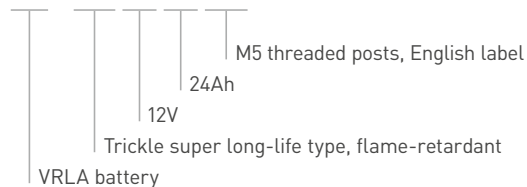

Model number	Nominal voltage (V)	Nominal capacity (Ah) 20 hours rate	Length (mm)	Width (mm)	Total height (mm)	Weight (kg)	VdS number	Page
LC-QA06210TP	6	210	173	407	250	36.5	-	104
LC-QA1224P/AP	12	24.0	125	165	175	9.9	-	106
LC-QA1242P	12	42.0	165	197	180	15.5	-	108
LC-QA1270P	12	70	166	350	175	23.5	-	110
LC-QA12110TP	12	110	173	407	236	36.0	-	112

*1 This battery is also available with a flame-retardant battery case resin (UL94 V-0).

*2 This battery is equipped with insert terminals.



UP-VW / -PW SERIES – TRICKLE DESIGN LIFE 6–9 AND 10–12 YEARS

The Panasonic UP-VW / -PW series offers up to 30% higher energy density compared to conventional VRLA batteries with the same dimensions. The series is ideal for UPS systems which require a short discharge time of about 30 minutes or less.

FEATURES

- 30% higher energy density compared to conventional VRLA batteries
- Superior quality
- 100% inspection after final assembly and before shipment
- Years of experience in production
- Batteries with flame-retardant battery container according to UL94 V-0

APPLICATIONS

- UPS systems
- Servers, etc.

MODEL NUMBER (EXAMPLE)

UP - P W 1 2 4 5 P

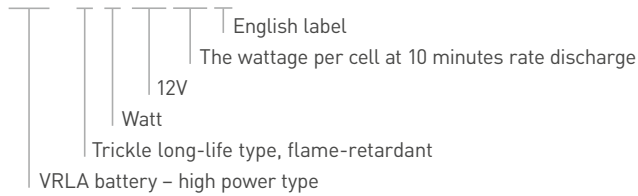

UP - V W 1 2 2 0 J 1

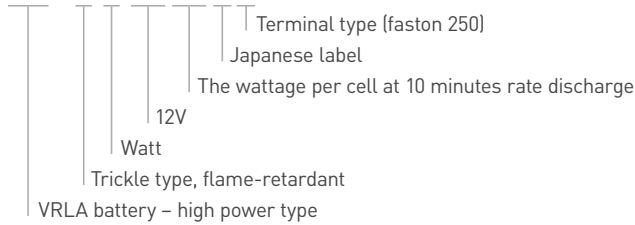

Model number	Nominal voltage (V)	Rated power (W) 10 minutes rate	Length (mm)	Width (mm)	Total height (mm)	Weight (kg)	VdS number	Page
UP-VW0645P1	6	135	34	151	100	1.30	-	114
UP-VW1220P1	12	120	38.5	140	100	1.30	-	116
UP-VW1228P1	12	200	64.5	151	100	2.00	-	118
UP-VWA1232P1/P2	12	192	51	151	100	1.85	-	120
UP-VW1236P1	12	224	64.5	151	100	2.05	-	122
UP-VW1245P1	12	270	64.5	151	100	2.55	-	124
UP-PW1245P1	12	270	64.5	151	100	2.60	-	126



LC CYCLIC SERIES

The Panasonic LC cyclic series is a main power source for electrical devices which require reliable power frequently. Based on our proven technology for standby and occasional back-up, this series uses different plate design and other tweaks to achieve long cycle life.

FEATURES

- State-of-the-art Absorbed Glass Mat (AGM) technology
- Superior design and low voltage spread gives excellent performance
- Enhanced lifespan due to excellent recombination efficiency
- Highest quality control standards
- Years of experience in production
- Selected batteries with flame-retardant battery containers according to UL94 V-0
- Various VdS approved batteries

APPLICATIONS

- Solar street lighting
- Medical equipment
- Lawn mowers
- Automated guided vehicles
- Wheelchairs, etc.

LC CYCLIC – CYCLE LONG-LIFE AND CYCLE LONG-LIFE FOR ENERGY STORAGE

MODEL NUMBER (EXAMPLE)

LC - CA 12 16 P

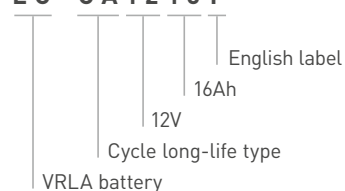

Model number	Nominal voltage (V)	Nominal capacity (Ah) 20 hours rate	Length (mm)	Width (mm)	Total height (mm)	Weight (kg)	VdS number	Page
LC-CA1212P/P1	12	12.0	98	151	100	3.80	-	128
LC-CA1215P/P1	12	15.0	98	151	100	4.20	-	130
LC-CA1216P/P1	12	16.0	98	151	105	4.70	-	132
LC-XC1222P/AP	12	22.0	76	181	167	6.55	-	134
LC-XC1228P/AP	12	28.0	125	165	179.5	10.5	-	136
LC-XC1238P/AP	12	38.0	165	197	179.5	15.0	-	138
LC-T1270P*1	12	70	166	350	175	24.5	-	140
LC-T12105P*1	12	105	173	407	236	34.0	-	142

*1 This battery type is designed for energy storage applications.

LC-R061R3P*1

FOR MAIN AND STANDBY POWER SUPPLIES.
 EXPECTED TRICKLE DESIGN LIFE: 6 - 9 YEARS AT 20°C
 ACCORDING TO EUROBAT.

DIMENSIONS (MM)



Contents indicated (including the recycle marking, etc.) are subject to change without notice. Battery case resin: standard (UL94 HB)

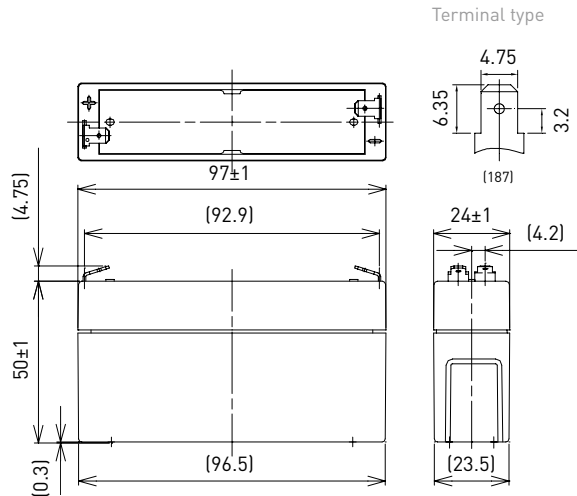

Terminal type

Specifications		LC-R061R3P*1
Nominal voltage (V)		6
Nominal capacity	20 hours rate (Ah)	1.3
Dimensions	Length (mm)	24
	Width (mm)	97
	Total height (mm)	55
Approx. mass (kg)		0.25
Terminal type		Faston 187
Capacity (25°C)	20 hours rate (Ah)	1.3
	10 hours rate (Ah)	1.1
	3 hours rate (Ah)	1.0
	1 hour rate (Ah)	0.9
Impedance (mΩ)	Fully charged battery (25°C)	50
Temperature dependency of capacity (%) - 20 hour rate	40°C	102
	25°C	100
	0°C	85
	-15°C	65
Remaining capacity (25°C)	After 3 months (%)	91
	After 6 months (%)	82
	After 12 months (%)	64

DURATION OF DISCHARGE VS. DISCHARGE CURRENT

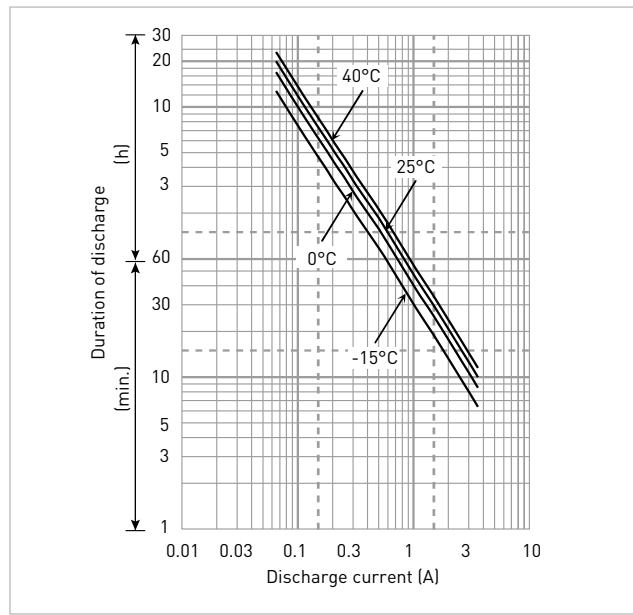

WATT TABLE (25°C)

(Wattage/battery)

Cut-off	3min.	5min.	10min.	15min.	20min.	30min.	45min.	1h	1.5h	2h	3h	4h	5h	6h	10h	20h
4.80V	39.1	30.8	20.1	15.4	12.9	9.61	6.78	5.42	3.73	2.89	2.15	1.65	1.36	1.10	0.726	0.393
4.95V	36.2	28.9	19.7	15.3	12.7	9.51	6.74	5.37	3.66	2.86	2.14	1.64	1.35	1.09	0.723	0.392
5.10V	33.4	27.1	19.2	15.0	12.5	9.40	6.68	5.32	3.58	2.79	2.12	1.63	1.34	1.08	0.715	0.391
5.25V	29.7	24.3	17.8	13.9	11.8	9.19	6.57	5.21	3.51	2.69	2.08	1.62	1.33	1.07	0.712	0.390
5.40V	25.1	21.4	15.9	13.0	11.5	8.87	6.47	5.10	3.41	2.57	2.04	1.60	1.30	1.05	0.704	0.388

AMPERE TABLE (25°C)

(Ampere/battery)

Cut-off	3min.	5min.	10min.	15min.	20min.	30min.	45min.	1h	1.5h	2h	3h	4h	5h	6h	10h	20h
4.80V	7.02	5.53	3.59	2.67	2.22	1.64	1.16	0.921	0.634	0.484	0.363	0.276	0.228	0.185	0.122	0.066
4.95V	6.52	5.18	3.52	2.65	2.18	1.63	1.15	0.912	0.621	0.480	0.361	0.274	0.226	0.184	0.121	0.065
5.10V	6.01	4.86	3.43	2.60	2.15	1.61	1.14	0.903	0.609	0.468	0.358	0.273	0.224	0.183	0.120	0.065
5.25V	5.34	4.35	3.18	2.42	2.04	1.57	1.12	0.885	0.596	0.451	0.352	0.272	0.222	0.182	0.119	0.065
5.40V	4.51	3.85	2.83	2.26	1.99	1.52	1.10	0.867	0.578	0.433	0.343	0.271	0.217	0.181	0.117	0.063

All mentioned values are average values

*1 This battery is also available with a flame retardant battery case resin (UL94 V-0): LC-V061R3P.

LC-R061R3P*1

CHARGING METHOD (25°C)

Cycle use	Control voltage: 7.25V - 7.45V Initial current: 0.52A or smaller
------------------	---

CUT-OFF VOLTAGE

Discharge current	0.065A - 0.26A	0.26A - 0.65A	0.65A - 1.30A	1.30A - 2.60A	2.60A - 3.90A
Cut-off voltage	5.25V	5.10V	4.95V	4.65V	4.35V

CYCLE LIFE VS. DEPTH OF DISCHARGE (ACC. IEC 61056)

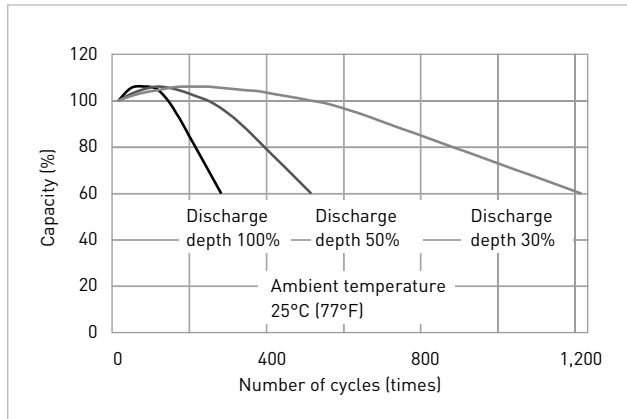

RESIDUAL CAPACITY TEST RESULT

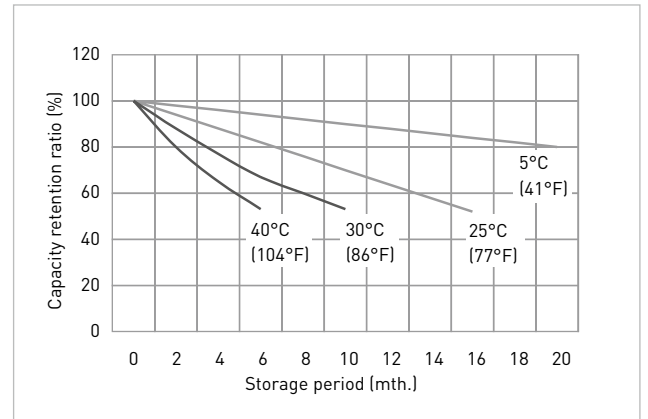

CONSTANT-VOLTAGE CONSTANT-CURRENT CHARGE CHARACTERISTICS FOR CYCLE USE

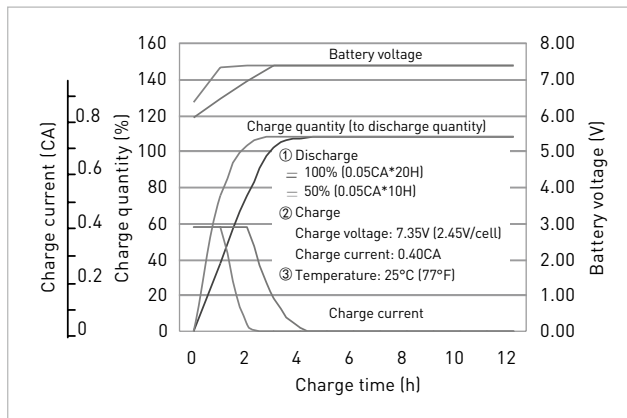

DISCHARGE CAPACITY BY TEMPERATURE AND BY DISCHARGE CURRENT

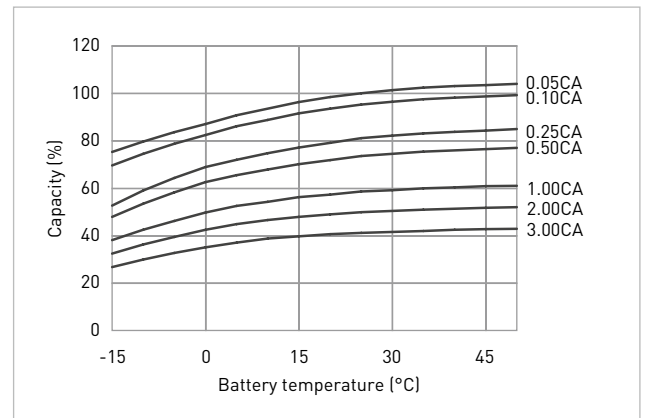

DISCHARGE CHARACTERISTICS

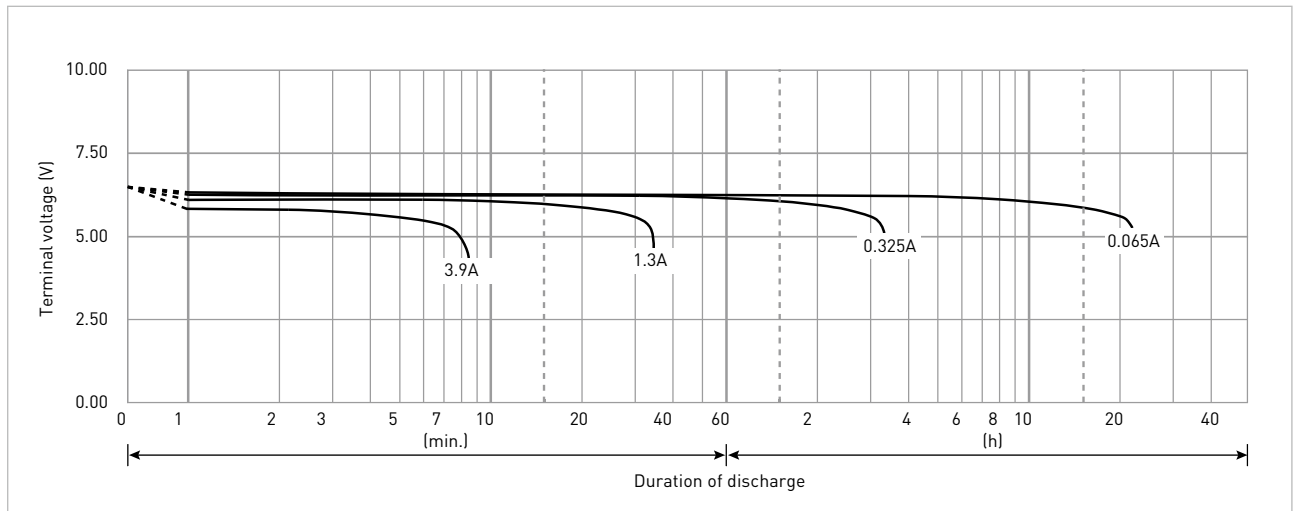

*1 This battery is also available with a flame retardant battery case resin (UL94 V-0): LC-V061R3P.

LC-R063R4P*1

FOR MAIN AND STANDBY POWER SUPPLIES.
 EXPECTED TRICKLE DESIGN LIFE: 6 - 9 YEARS AT 20°C
 ACCORDING TO EUROBAT.

DIMENSIONS (MM)



Terminal type

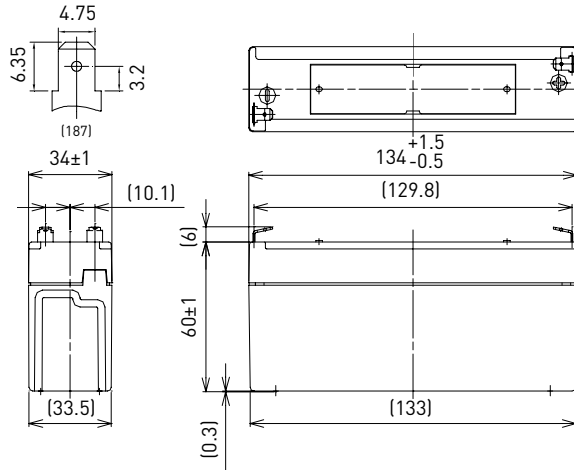

Contents indicated (including the recycle marking, etc.) are subject to change without notice. Battery case resin: standard (UL94 HB)

Specifications		LC-R063R4P*1
Nominal voltage (V)		6
Nominal capacity		
	20 hours rate (Ah)	3.4
Dimensions	Length (mm)	34
	Width (mm)	134
	Total height (mm)	66
Approx. mass (kg)		0.60
Terminal type		Faston 187
Capacity (25°C)	20 hours rate (Ah)	3.4
	10 hours rate (Ah)	3.1
	3 hours rate (Ah)	2.8
	1 hour rate (Ah)	2.3
Impedance (mΩ)	Fully charged battery (25°C)	30
Temperature dependency of capacity (%) - 20 hours rate	40°C	102
	25°C	100
	0°C	85
	-15°C	65
Remaining capacity (25°C)	After 3 monthss (%)	91
	After 6 monthss (%)	82
	After 12 monthss (%)	64

DURATION OF DISCHARGE VS. DISCHARGE CURRENT

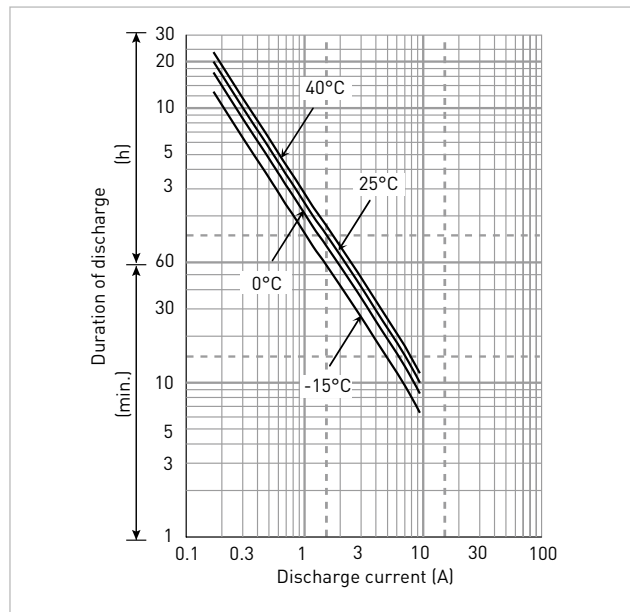

WATT TABLE (25°C)

(Wattage/battery)

Cut-off	3min.	5min.	10min.	15min.	20min.	30min.	45min.	1h	1.5h	2h	3h	4h	5h	6h	10h	20h
4.80V	102	80.6	52.6	40.2	33.7	25.1	17.7	14.2	9.76	7.55	5.62	4.32	3.56	2.86	1.90	1.03
4.95V	94.8	75.6	51.6	39.9	33.1	24.9	17.6	14.1	9.56	7.49	5.59	4.29	3.54	2.85	1.89	1.03
5.10V	87.4	70.8	50.2	39.1	32.6	24.6	17.5	13.9	9.37	7.30	5.54	4.26	3.51	2.83	1.87	1.02
5.25V	77.7	63.4	46.5	36.4	30.9	24.0	17.2	13.6	9.17	7.04	5.45	4.23	3.48	2.80	1.86	1.02
5.40V	65.6	56.1	41.5	33.9	30.1	23.2	16.9	13.4	8.92	6.71	5.34	4.18	3.39	2.75	1.84	1.01

AMPERE TABLE (25°C)

(Ampere/battery)

Cut-off	3min.	5min.	10min.	15min.	20min.	30min.	45min.	1h	1.5h	2h	3h	4h	5h	6h	10h	20h
4.80V	18.4	14.4	9.40	6.99	5.81	4.30	3.02	2.41	1.66	1.26	0.949	0.722	0.595	0.484	0.318	0.171
4.95V	17.0	13.6	9.21	6.94	5.71	4.25	3.00	2.39	1.62	1.24	0.945	0.718	0.590	0.482	0.316	0.171
5.10V	15.7	12.7	8.97	6.80	5.62	4.20	2.97	2.36	1.59	1.22	0.935	0.713	0.586	0.478	0.313	0.170
5.25V	14.0	11.4	8.31	6.33	5.34	4.11	2.93	2.31	1.56	1.18	0.921	0.710	0.581	0.475	0.312	0.170
5.40V	11.8	10.1	7.41	5.90	5.19	3.97	2.88	2.27	1.51	1.13	0.897	0.708	0.567	0.472	0.307	0.165

All mentioned values are average values

*1 This battery is also available with a flame-retardant battery case resin (UL94 V-0): LC-V063R4P.

LC-R063R4P*1

CHARGING METHOD (25°C)

Cycle use	Control voltage: 7.25V - 7.45V Initial current: 1.36A or smaller
------------------	---

CUT-OFF VOLTAGE

Discharge current	0.17A - 0.68A	0.68A - 1.7A	1.7A - 3.4A	3.4A - 6.8A	6.8A - 10.2A
Cut-off voltage	5.25V	5.10V	4.95V	4.65V	4.35V

CYCLE LIFE VS. DEPTH OF DISCHARGE (ACC. IEC 61056)

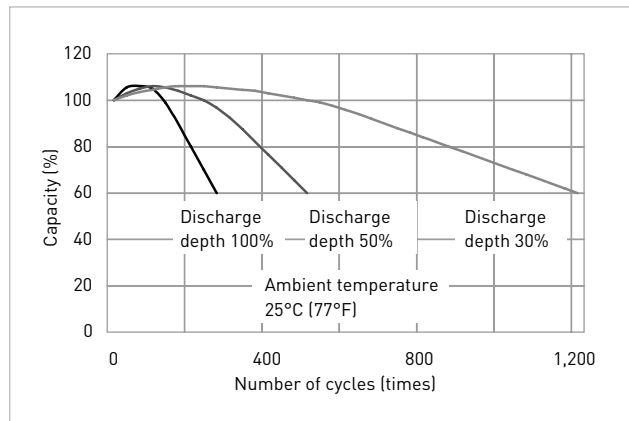

RESIDUAL CAPACITY TEST RESULT

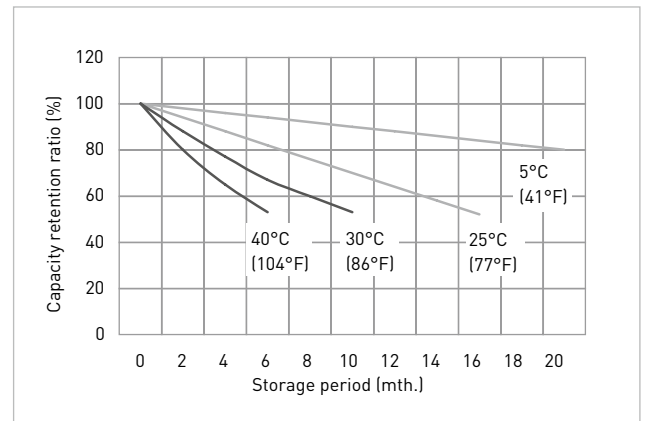

CONSTANT-VOLTAGE CONSTANT-CURRENT CHARGE CHARACTERISTICS FOR CYCLE USE

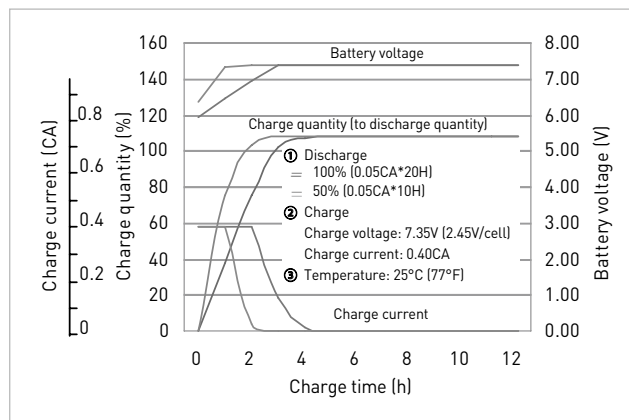

DISCHARGE CAPACITY BY TEMPERATURE AND BY DISCHARGE CURRENT

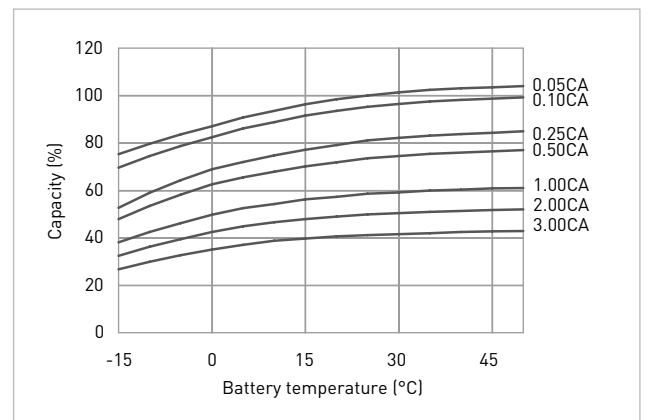

DISCHARGE CHARACTERISTICS

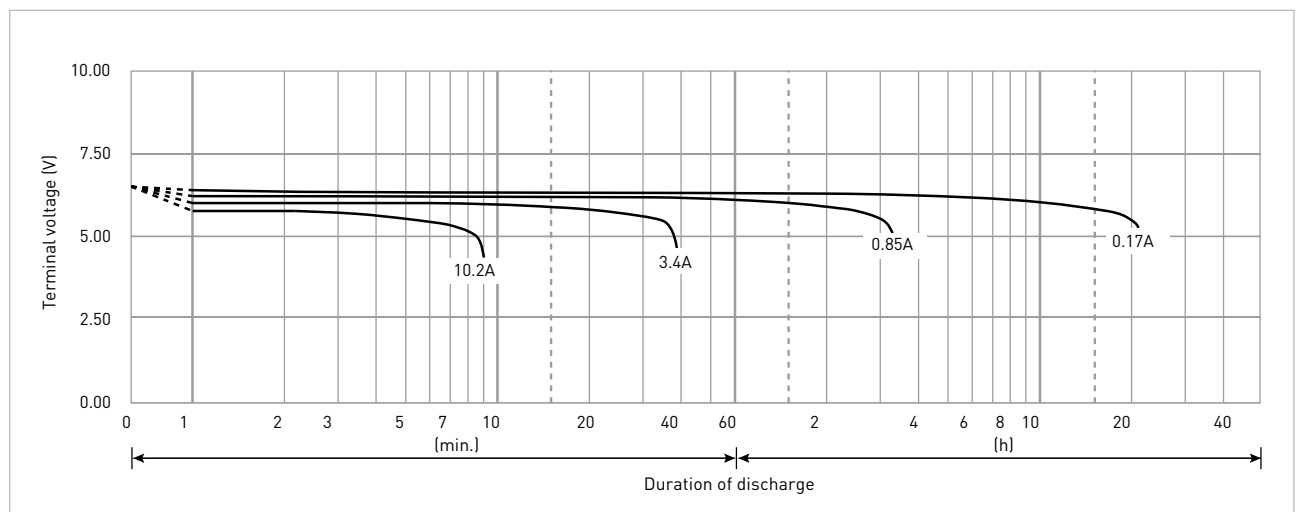

*1 This battery is also available with a flame-retardant battery case resin (UL94 V-0): LC-V063R4P.

LC-R064R5P*1

FOR MAIN AND STANDBY POWER SUPPLIES.
 EXPECTED TRICKLE DESIGN LIFE: 6 - 9 YEARS AT 20°C
 ACCORDING TO EUROBAT.

DIMENSIONS (MM)

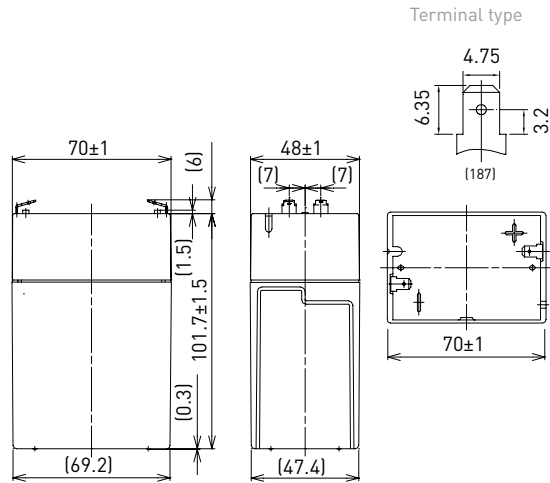

Contents indicated (including the recycle marking, etc.) are subject to change without notice. Battery case resin: standard (UL94 HB)

Specifications		LC-R064R5P*1
Nominal voltage (V)		6
Nominal capacity	20 hours rate (Ah)	4.5
Dimensions	Length (mm)	48
	Width (mm)	70
	Total height (mm)	108
Approx. mass (kg)		0.70
Terminal type		Faston 187
Capacity (25°C)	20 hours rate (Ah)	4.5
	10 hours rate (Ah)	4.1
	3 hours rate (Ah)	3.6
	1 hour rate (Ah)	3.1
Impedance (mΩ)	Fully charged battery (25°C)	20
	40°C	102
Temperature dependency of capacity (%) - 20 hours rate	25°C	100
	0°C	85
	-15°C	65
	Remaining capacity (25°C)	
After 3 months (%)		91
After 6 months (%)		82
After 12 months (%)		64

DURATION OF DISCHARGE VS. DISCHARGE CURRENT

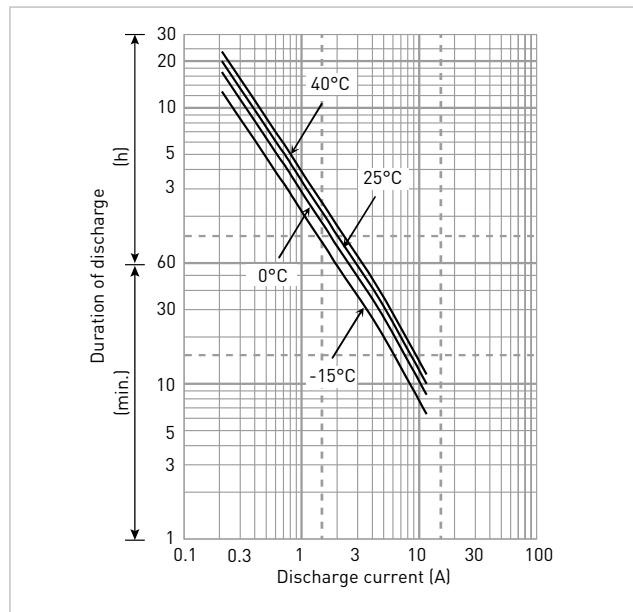

WATT TABLE (25°C)

(Wattage/battery)

Cut-off	3min.	5min.	10min.	15min.	20min.	30min.	45min.	1h	1.5h	2h	3h	4h	5h	6h	10h	20h
4.80V	135.0	107	69.7	53.2	44.6	33.3	23.5	18.8	12.9	9.99	7.44	5.71	4.72	3.79	2.51	1.36
4.95V	125.0	100	68.3	52.8	43.9	32.9	23.3	18.6	12.7	9.92	7.40	5.68	4.68	3.78	2.50	1.36
5.10V	116.0	93.7	66.5	51.8	43.1	32.5	23.1	18.4	12.4	9.66	7.33	5.64	4.64	3.75	2.48	1.35
5.25V	103.0	84.0	61.6	48.2	41.0	31.8	22.7	18.0	12.1	9.32	7.21	5.60	4.60	3.70	2.46	1.35
5.40V	86.9	74.2	55.0	44.9	39.9	30.7	22.4	17.7	11.8	8.88	7.07	5.53	4.49	3.64	2.44	1.34

AMPERE TABLE (25°C)

(Ampere/battery)

Cut-off	3min.	5min.	10min.	15min.	20min.	30min.	45min.	1h	1.5h	2h	3h	4h	5h	6h	10h	20h
4.80V	24.3	19.1	12.4	9.25	7.69	5.69	4.00	3.19	2.19	1.69	1.25	0.956	0.788	0.633	0.419	0.227
4.95V	22.6	17.9	12.2	9.19	7.56	5.63	3.98	3.16	2.14	1.68	1.24	0.950	0.781	0.630	0.417	0.226
5.10V	20.8	16.8	11.9	9.00	7.44	5.56	3.94	3.13	2.10	1.63	1.23	0.944	0.775	0.625	0.413	0.226
5.25V	18.5	15.1	11.0	8.38	7.06	5.44	3.88	3.06	2.06	1.58	1.21	0.938	0.769	0.618	0.411	0.225
5.40V	15.6	13.3	9.81	7.81	6.88	5.25	3.81	3.00	2.00	1.50	1.19	0.925	0.750	0.608	0.406	0.224

All mentioned values are average values

*1 This battery is also available with a flame-retardant battery case resin (UL94 V-0): LC-V064R5P.

LC-R064R5P*1

CHARGING METHOD (25°C)

Cycle use	Control voltage: 7.25V - 7.45V Initial current: 1.80A or smaller
------------------	---

CUT-OFF VOLTAGE

Discharge current	0.225A - 0.900A	0.900A - 2.25A	2.25A - 4.50A	4.50A - 9.00A	9.00A - 13.5A
Cut-off voltage	5.25V	5.10V	4.95V	4.65V	4.35V

CYCLE LIFE VS. DEPTH OF DISCHARGE (ACC. IEC 61056)

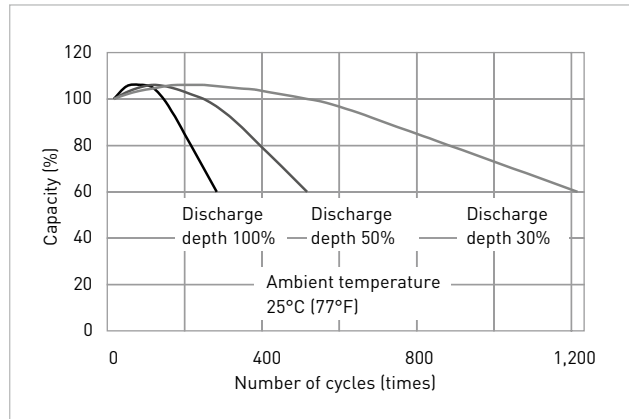

RESIDUAL CAPACITY TEST RESULT

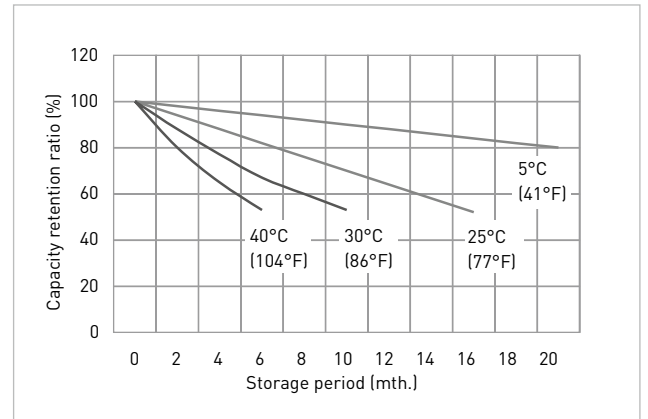

CONSTANT-VOLTAGE CONSTANT-CURRENT CHARGE CHARACTERISTICS FOR CYCLE USE

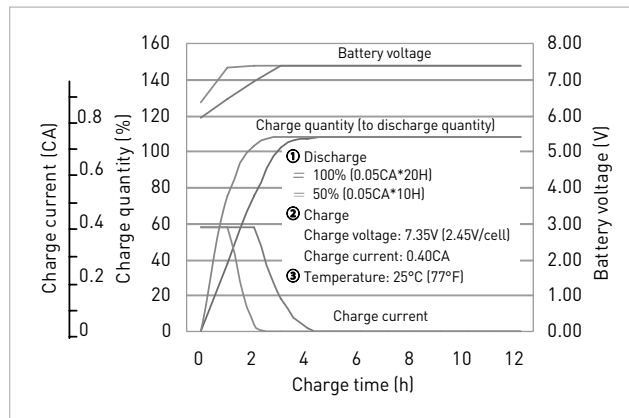

DISCHARGE CAPACITY BY TEMPERATURE AND BY DISCHARGE CURRENT

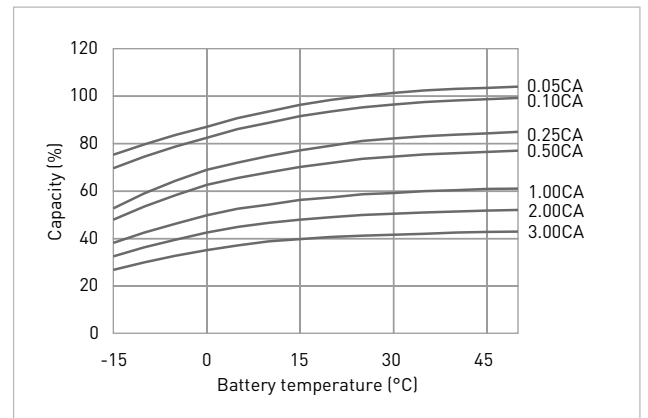

DISCHARGE CHARACTERISTICS

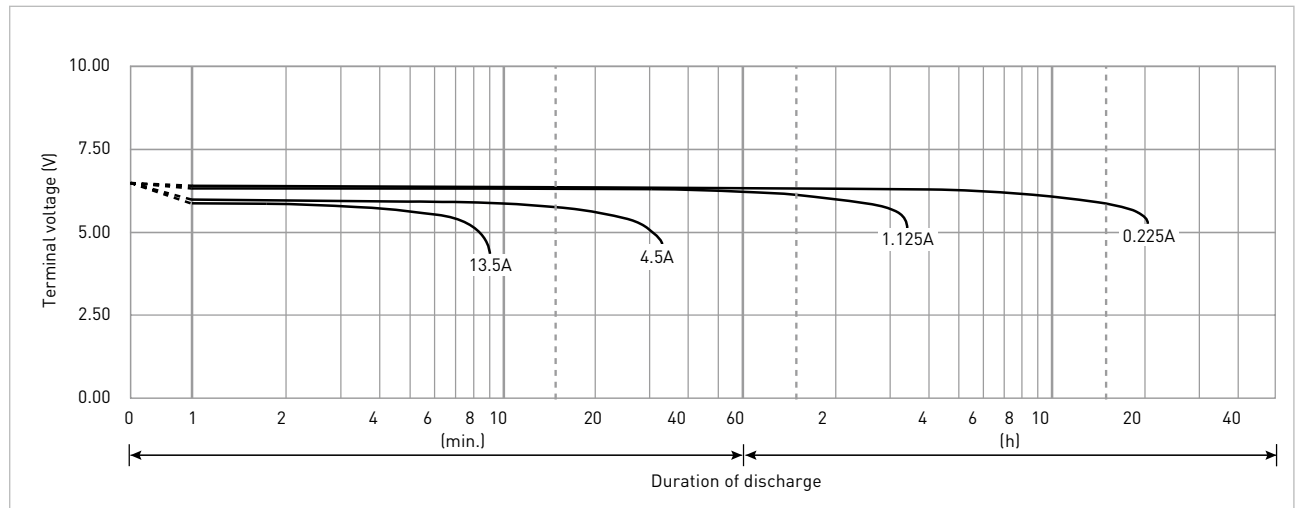

*1 This battery is also available with a flame-retardant battery case resin (UL94 V-0): LC-V064R5P.

LC-R067R2P/P1*1

FOR MAIN AND STANDBY POWER SUPPLIES.
 EXPECTED TRICKLE DESIGN LIFE: 6 - 9 YEARS AT 20°C
 ACCORDING TO EUROBAT.

DIMENSIONS (MM)

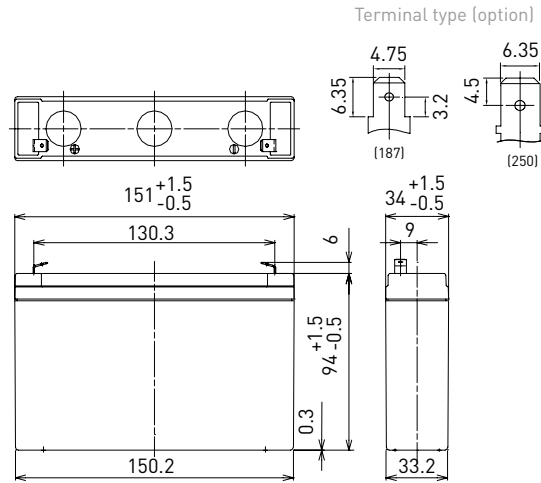

Contents indicated (including the recycle marking, etc.) are subject to change without notice. Battery case resin: standard (UL94 HB)

Specifications		LC-R067R2P/P1*1
Nominal voltage (V)		6
Nominal capacity	20 hours rate (Ah)	7.2
Dimensions	Length (mm)	34
	Width (mm)	151
	Total height (mm)	100
Approx. mass (kg)		1.30
Terminal type		Faston 187/250
Capacity (25°C)	20 hours rate (Ah)	7.2
	10 hours rate (Ah)	6.6
	3 hours rate (Ah)	5.8
	1 hour rate (Ah)	4.9
Impedance (mΩ)	Fully charged battery (25°C)	11
	Temperature dependency of capacity (%) - 20 hours rate	
	40°C	102
	25°C	100
	0°C	85
	-15°C	65
Remaining capacity (25°C)	After 3 months (%)	91
	After 6 months (%)	82
	After 12 months (%)	64

DURATION OF DISCHARGE VS. DISCHARGE CURRENT

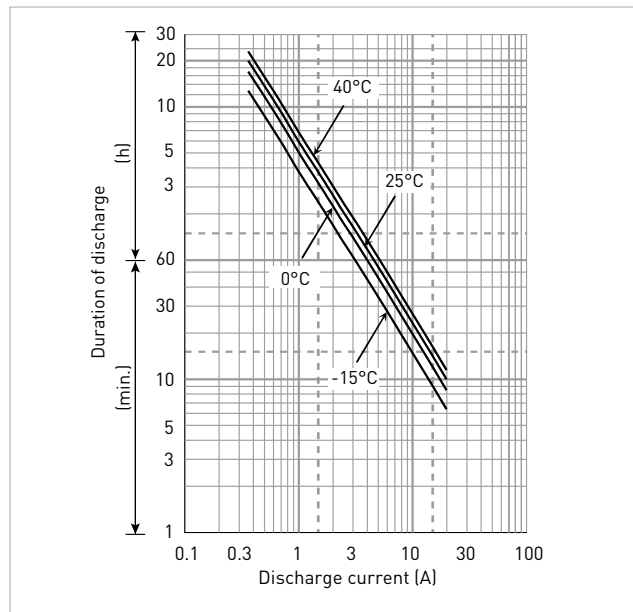

WATT TABLE (25°C)

(Wattage/battery)

Cut-off	3min.	5min.	10min.	15min.	20min.	30min.	45min.	1h	1.5h	2h	3h	4h	5h	6h	10h	20h
4.80V	215	167	110	83.5	67.1	49.2	36.0	28.2	22.3	17.3	12.3	9.60	7.69	6.40	4.19	2.30
4.95V	202	143	93.5	79.5	64.8	48.2	35.8	27.6	21.9	17.2	12.1	9.53	7.63	6.27	4.18	2.29
5.10V	189	136	91.0	75.5	63.0	47.2	34.3	26.8	20.7	16.3	11.8	9.33	7.32	6.11	4.00	2.21
5.25V	172	124	86.8	72.2	60.2	45.4	33.4	26.2	19.9	15.8	11.5	9.15	7.27	6.05	3.98	2.14
5.40V	154	112	82.0	69.1	57.7	43.6	31.3	24.2	18.6	14.0	10.7	8.46	6.67	5.60	3.71	2.07

AMPERE TABLE (25°C)

(Ampere/battery)

Cut-off	3min.	5min.	10min.	15min.	20min.	30min.	45min.	1h	1.5h	2h	3h	4h	5h	6h	10h	20h
4.80V	38.9	30.6	19.9	14.8	12.3	9.10	6.40	5.10	3.50	2.70	2.00	1.53	1.26	1.02	0.670	0.363
4.95V	36.1	28.7	19.5	14.7	12.1	9.00	6.36	5.05	3.43	2.68	1.99	1.52	1.25	1.01	0.667	0.362
5.10V	34.2	26.9	19.0	14.4	11.9	8.90	6.30	5.00	3.36	2.61	1.97	1.51	1.24	1.00	0.660	0.361
5.25V	31.4	24.1	17.6	13.4	11.3	8.70	6.20	4.90	3.29	2.52	1.94	1.50	1.23	0.988	0.657	0.360
5.40V	29.0	22.3	15.7	12.5	11.0	8.40	6.10	4.80	3.20	2.40	1.90	1.48	1.20	0.972	0.650	0.358

All mentioned values are average values

*1 This battery is also available with a flame-retardant battery case resin (UL94 V-0): LC-V067R2P/P1.

LC-R067R2P/P1*1

CHARGING METHOD (25°C)

Cycle use	Control voltage: 7.25V - 7.45V Initial current: 2.88A or smaller
------------------	---

CUT-OFF VOLTAGE

Discharge current	0.360A - 1.44A	1.44A - 3.60A	3.60A - 7.20A	7.20A - 14.4A	14.4A - 21.6A
Cut-off voltage	5.25V	5.10V	4.95V	4.65V	4.35V

CYCLE LIFE VS. DEPTH OF DISCHARGE (ACC. IEC 61056)

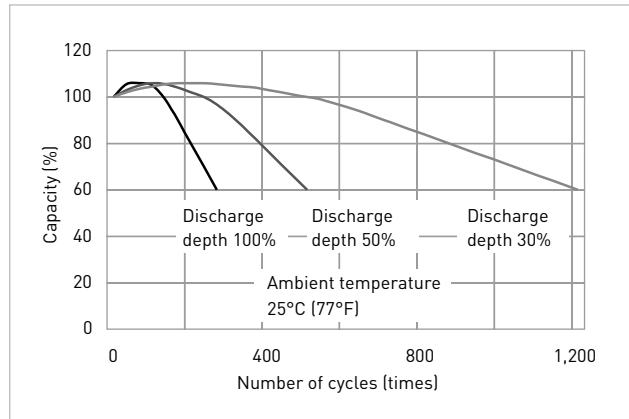

RESIDUAL CAPACITY TEST RESULT

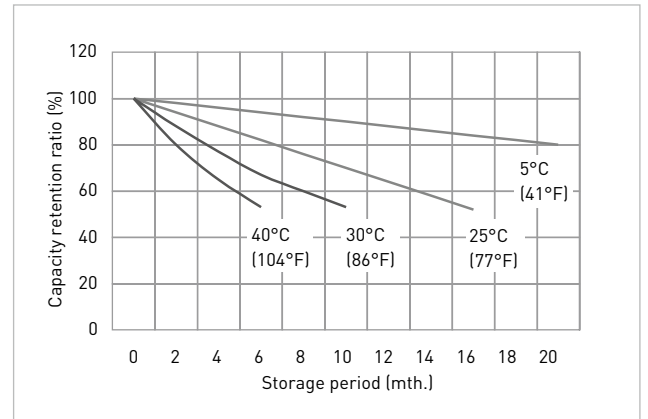

CONSTANT-VOLTAGE CONSTANT-CURRENT CHARGE CHARACTERISTICS FOR CYCLE USE

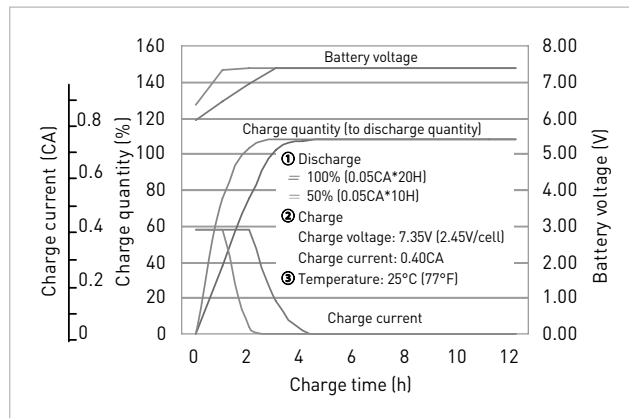

DISCHARGE CAPACITY BY TEMPERATURE AND BY DISCHARGE CURRENT

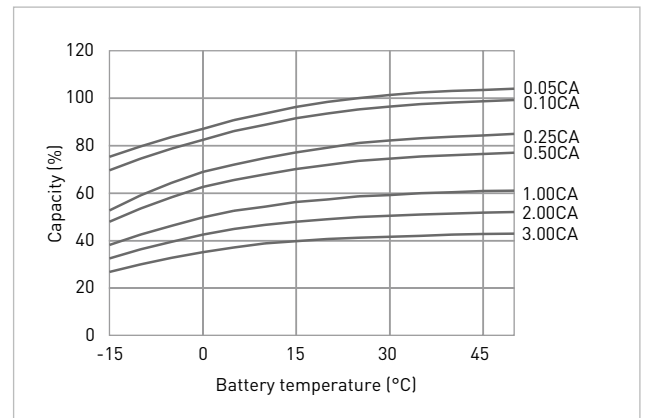

DISCHARGE CHARACTERISTICS

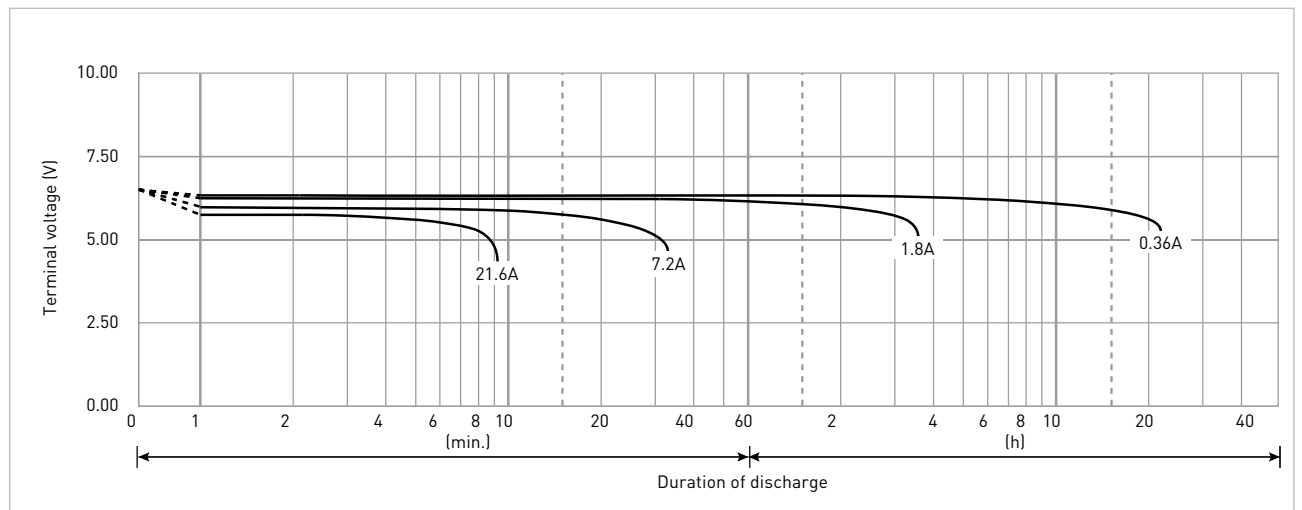

*1 This battery is also available with a flame-retardant battery case resin (UL94 V-0): LC-V067R2P/P1.

LC-R0612P/P1*1

FOR MAIN AND STANDBY POWER SUPPLIES.
 EXPECTED TRICKLE DESIGN LIFE: 6 - 9 YEARS AT 20°C
 ACCORDING TO EUROBAT.

DIMENSIONS (MM)

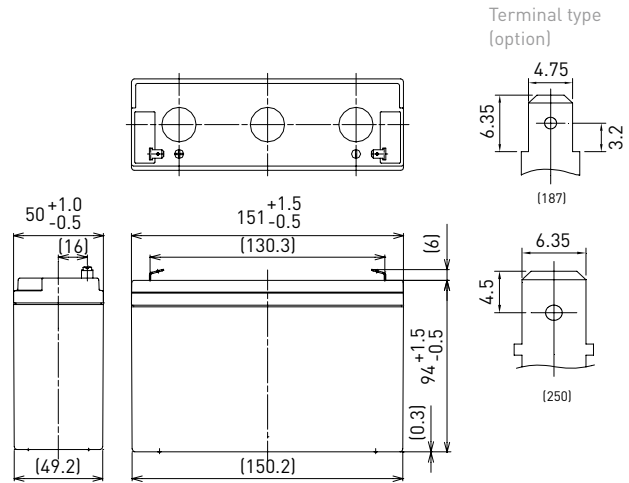

Contents indicated (including the recycle marking, etc.) are subject to change without notice. Battery case resin: standard (UL94 HB)

Specifications		LC-R0612P/P1*
Nominal voltage (V)		6
Nominal capacity	20 hours rate (Ah)	12.0
Dimensions	Length (mm)	50
	Width (mm)	151
	Total height (mm)	100
Approx. mass (kg)		1.95
Terminal type		Faston 187/250
Capacity (25°C)	20 hours rate (Ah)	12.0
	10 hours rate (Ah)	6.6
	3 hours rate (Ah)	5.8
	1 hour rate (Ah)	4.9
Impedance (mΩ)	Fully charged battery (25°C)	11
	Temperature dependency of capacity (%) - 20 hours rate	
	40°C	102
	25°C	100
	0°C	85
	-15°C	65
Remaining capacity (25°C)	After 3 months (%)	91
	After 6 months (%)	82
	After 12 months (%)	64

DURATION OF DISCHARGE VS. DISCHARGE CURRENT

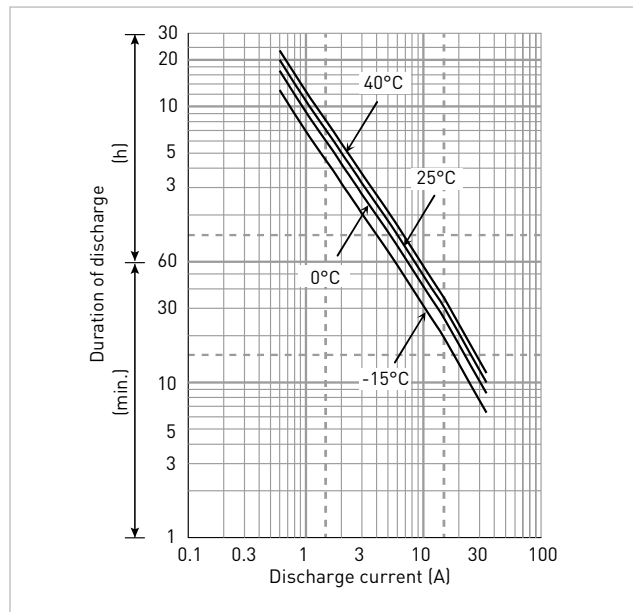

WATT TABLE (25°C)

(Wattage/battery)

Cut-off	3min.	5min.	10min.	15min.	20min.	30min.	45min.	1h	1.5h	2h	3h	4h	5h	6h	10h	20h
4.80V	340	279	192	149	124	91.3	68.7	52.4	35.1	27.2	19.0	14.4	12.0	10.9	6.66	3.61
4.95V	325	269	186	144	121	88.3	67.5	51.8	35.0	27.1	18.9	14.4	12.0	10.9	6.66	3.61
5.10V	304	253	181	141	118	87.2	66.9	51.2	34.5	26.9	18.7	14.4	12.0	10.8	6.60	3.61
5.25V	278	237	171	136	115	86.0	66.3	50.1	34.2	26.6	18.4	14.3	12.0	10.8	6.60	3.60
5.40V	247	217	161	131	113	83.1	61.6	48.9	33.1	26.0	18.1	14.2	11.9	10.7	6.54	3.59

AMPERE TABLE (25°C)

(Ampere/battery)

Cut-off	3min.	5min.	10min.	15min.	20min.	30min.	45min.	1h	1.5h	2h	3h	4h	5h	6h	10h	20h
4.80V	61.1	50.1	34.3	25.9	21.3	15.6	11.7	8.90	5.95	4.60	3.20	2.41	2.01	1.81	1.11	0.602
4.95V	58.4	48.2	33.3	25.0	20.8	15.1	11.5	8.80	5.92	4.58	3.18	2.41	2.01	1.81	1.11	0.602
5.10V	54.6	45.4	32.4	24.5	20.3	14.9	11.4	8.70	5.85	4.55	3.15	2.41	2.00	1.80	1.10	0.601
5.25V	50.0	42.6	30.6	23.6	19.9	14.7	11.3	8.50	5.80	4.50	3.10	2.40	2.00	1.80	1.10	0.600
5.40V	44.5	38.9	28.7	22.7	19.4	14.2	10.5	8.30	5.60	4.40	3.05	2.38	1.99	1.79	1.09	0.598

All mentioned values are average values

*1 This battery is also available with a flame-retardant battery case resin (UL94 V-0): LC-V0612P/P1.

LC-R0612P/P1*1

CHARGING METHOD (25°C)

Cycle use	Control voltage: 7.25V - 7.45V Initial current: 4.80A or smaller
------------------	---

CUT-OFF VOLTAGE

Discharge current	0.600A - 2.40A	2.40A - 6.00A	6.00A - 12.0A	12.0A - 24.0A	24.0A - 36.0A
Cut-off voltage	5.25V	5.10V	4.95V	4.65V	4.35V

CYCLE LIFE VS. DEPTH OF DISCHARGE (ACC. IEC 61056)

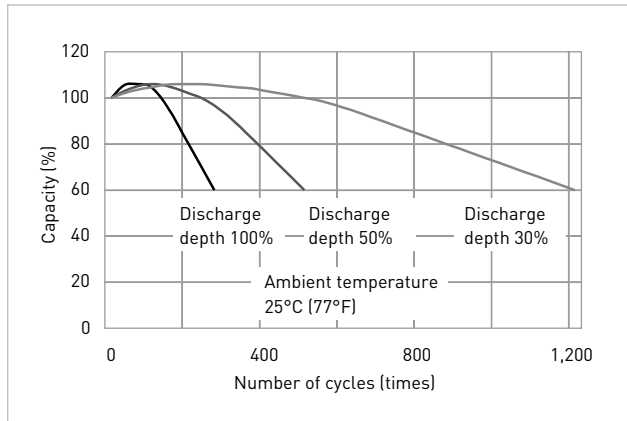

RESIDUAL CAPACITY TEST RESULT

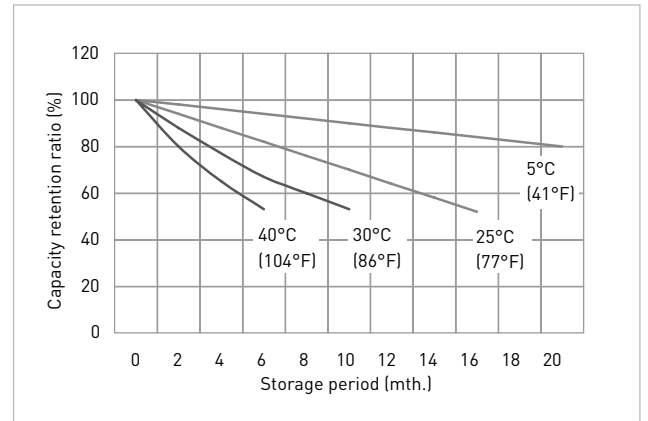

CONSTANT-VOLTAGE CONSTANT-CURRENT CHARGE CHARACTERISTICS FOR CYCLE USE

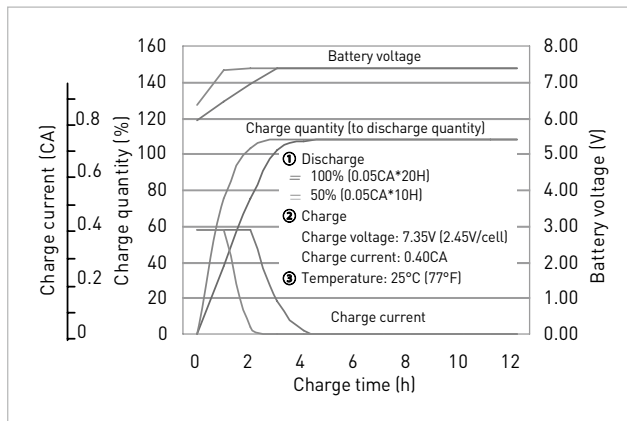

DISCHARGE CAPACITY BY TEMPERATURE AND BY DISCHARGE CURRENT

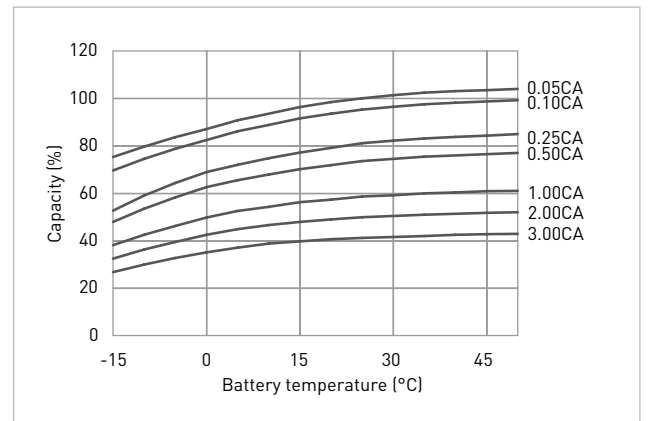

DISCHARGE CHARACTERISTICS

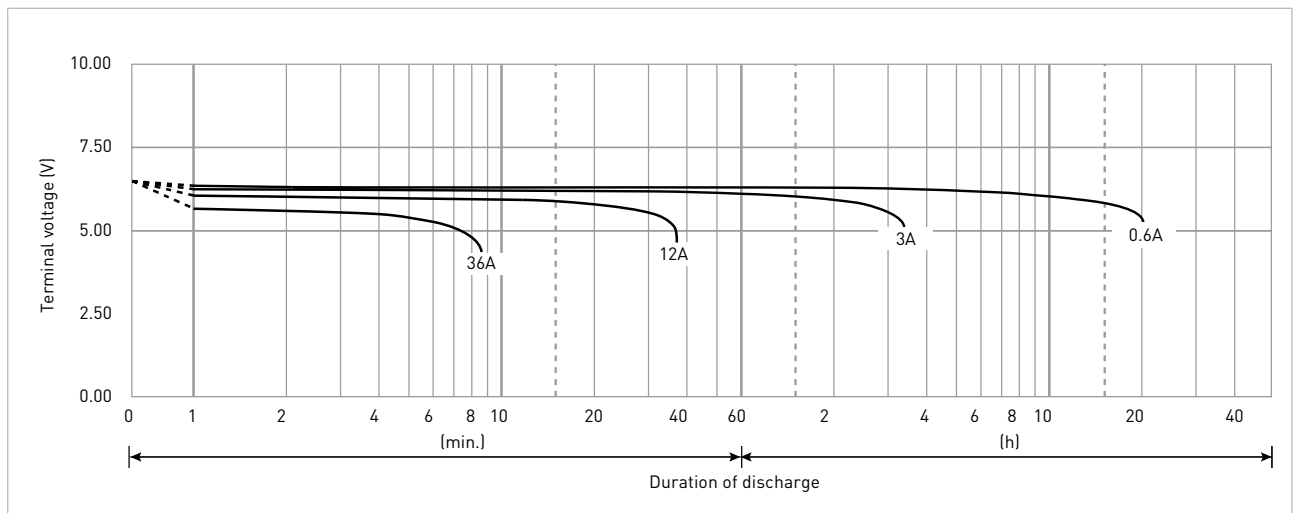

*1 This battery is also available with a flame-retardant battery case resin (UL94 V-0): LC-V0612P/P1.

LC-R121R3PG*1

FOR MAIN AND STANDBY POWER SUPPLIES.
 EXPECTED TRICKLE DESIGN LIFE: 6 - 9 YEARS
 AT 20°C ACCORDING TO EUROBAT.



G196049

DIMENSIONS (MM)



Terminal type

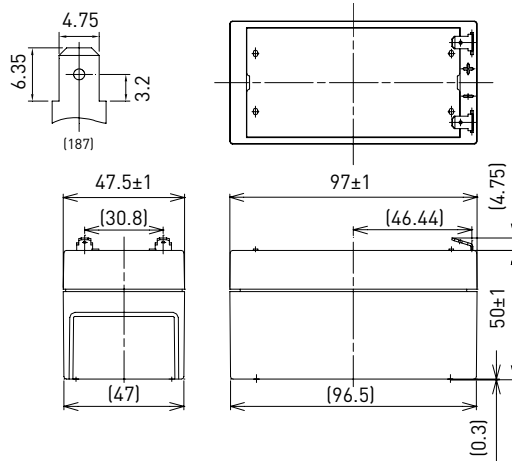

Contents indicated (including the recycle marking, etc.) are subject to change without notice. Battery case resin: standard (UL94 HB)

Specifications		LC-R121R3PG*1
Nominal voltage (V)		12
Nominal capacity	20 hours rate (Ah)	1.3
Dimensions	Length (mm)	47.5
	Width (mm)	97
	Total height (mm)	55
Approx. mass (kg)		0.59
Terminal type		Faston 187
Capacity (25°C)	20 hours rate (Ah)	1.3
	10 hours rate (Ah)	1.2
	3 hours rate (Ah)	1.1
	1 hour rate (Ah)	0.9
Impedance (mΩ)	Fully charged battery (25°C)	90
	Temperature dependency of capacity (%) - 20 hours rate	
	40°C	102
	25°C	100
	0°C	85
	-15°C	65
Remaining capacity (25°C)	After 3 months (%)	91
	After 6 months (%)	82
	After 12 months (%)	64

DURATION OF DISCHARGE VS. DISCHARGE CURRENT

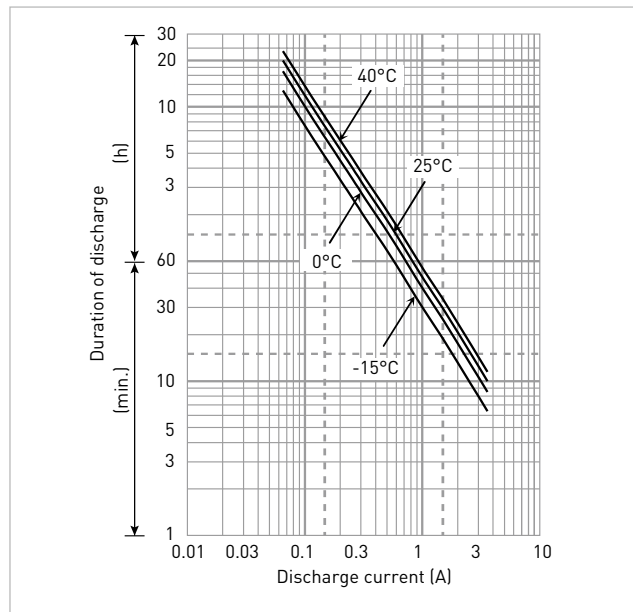

WATT TABLE (25°C)

(Wattage/battery)

Cut-off	3min.	5min.	10min.	15min.	20min.	30min.	45min.	1h	1.5h	2h	3h	4h	5h	6h	10h	20h
9.6V	78.1	61.6	40.2	30.7	25.8	19.2	13.6	10.8	7.49	5.73	4.32	3.30	2.73	2.22	1.46	0.787
9.9V	72.5	57.8	39.4	30.5	25.3	19.0	13.5	10.7	7.34	5.68	4.30	3.28	2.70	2.21	1.45	0.784
10.2V	66.9	54.2	38.4	29.9	24.9	18.8	13.4	10.6	7.19	5.54	4.25	3.26	2.68	2.19	1.44	0.782
10.5V	59.4	48.5	35.6	27.8	23.7	18.4	13.1	10.4	7.04	5.34	4.19	3.25	2.66	2.17	1.43	0.780
10.8V	50.2	42.9	31.7	26.0	23.0	17.7	12.9	10.2	6.82	5.13	4.08	3.24	2.60	2.16	1.41	0.758

AMPERE TABLE (25°C)

(Ampere/battery)

Cut-off	3min.	5min.	10min.	15min.	20min.	30min.	45min.	1h	1.5h	2h	3h	4h	5h	6h	10h	20h
9.6V	7.02	5.53	3.59	2.67	2.22	1.64	1.16	0.921	0.634	0.484	0.363	0.276	0.228	0.185	0.122	0.0655
9.9V	6.52	5.18	3.52	2.65	2.18	1.63	1.15	0.912	0.621	0.480	0.361	0.274	0.226	0.184	0.121	0.0654
10.2V	6.01	4.86	3.43	2.60	2.15	1.61	1.14	0.903	0.609	0.468	0.358	0.273	0.224	0.183	0.120	0.0652
10.5V	5.34	4.35	3.18	2.42	2.04	1.57	1.12	0.885	0.596	0.451	0.352	0.272	0.222	0.182	0.119	0.0650
10.8V	4.51	3.85	2.83	2.26	1.99	1.52	1.10	0.867	0.578	0.433	0.343	0.271	0.217	0.181	0.117	0.0632

All mentioned values are average values

*1 This battery is also available with a flame-retardant battery case resin (UL94 V-0): LC-V121R3PG.

LC-R121R3PG*1

CHARGING METHOD (25°C)

Cycle use	Control voltage: 14.5V - 14.9V Initial current: 0.52A or smaller
------------------	---

CUT-OFF VOLTAGE

Discharge current	0.065A - 0.26A	0.26A - 0.65A	0.65A - 1.3A	1.3A - 2.6A	2.6A - 3.9A
Cut-off voltage	10.5V	10.2V	9.9V	9.3V	8.7V

CYCLE LIFE VS. DEPTH OF DISCHARGE (ACC. IEC 61056)

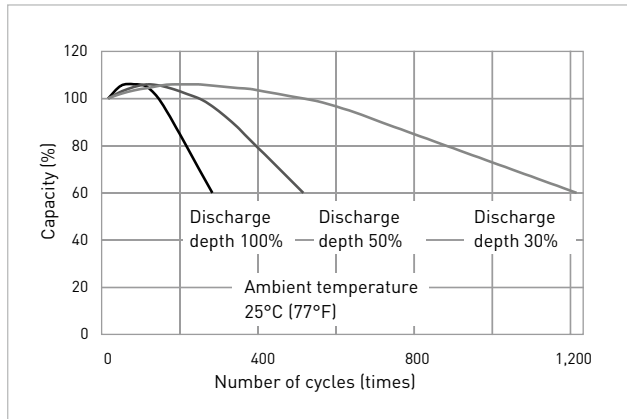

RESIDUAL CAPACITY TEST RESULT

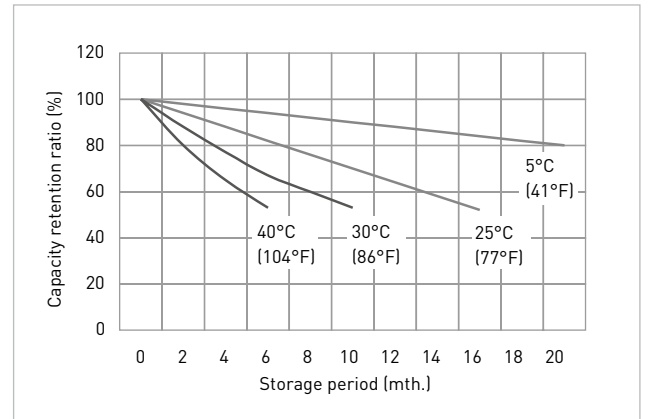

CONSTANT-VOLTAGE CONSTANT-CURRENT CHARGE CHARACTERISTICS FOR CYCLE USE

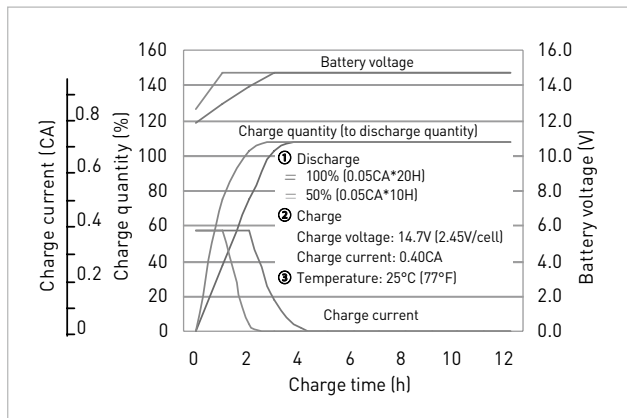

DISCHARGE CAPACITY BY TEMPERATURE AND BY DISCHARGE CURRENT

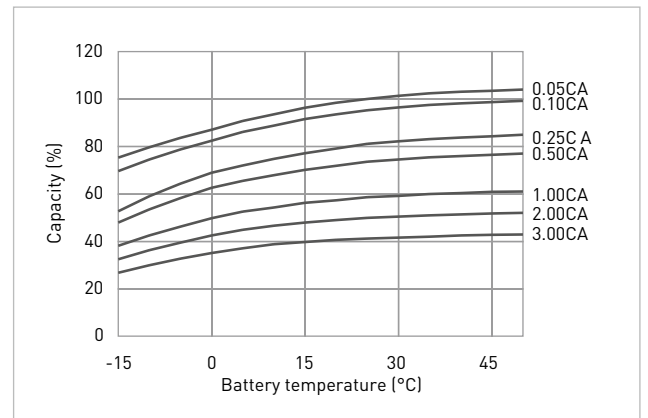

DISCHARGE CHARACTERISTICS

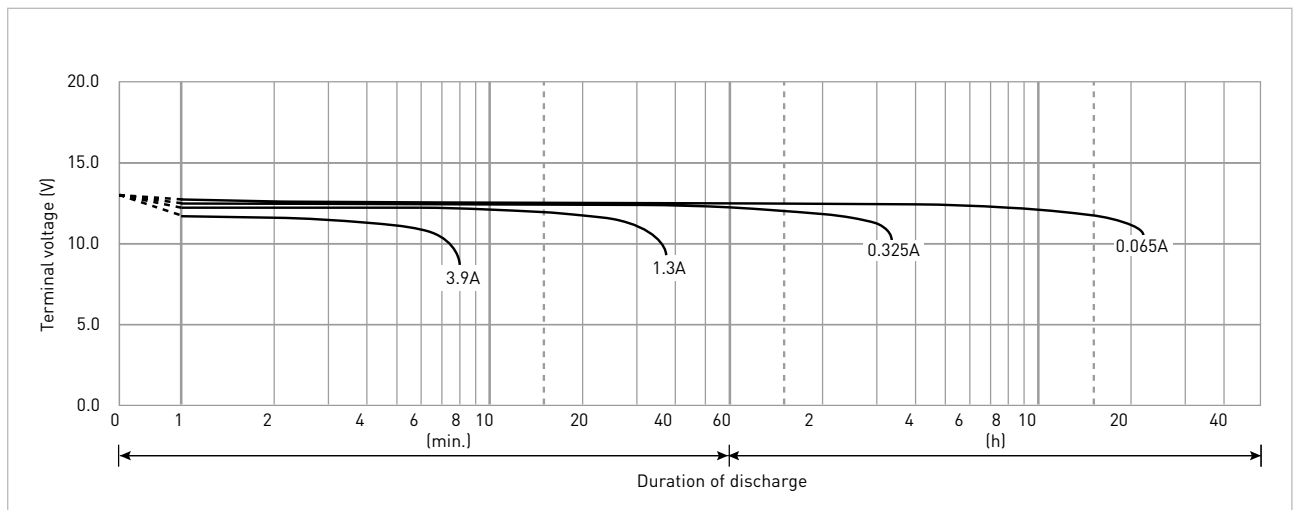

*1 This battery is also available with a flame-retardant battery case resin (UL94 V-0): LC-V121R3PG.

LC-R122R2PG*1

FOR MAIN AND STANDBY POWER SUPPLIES.
EXPECTED TRICKLE DESIGN LIFE: 6 - 9 YEARS
AT 20°C ACCORDING TO EUROBAT.



G188151

DIMENSIONS (MM)

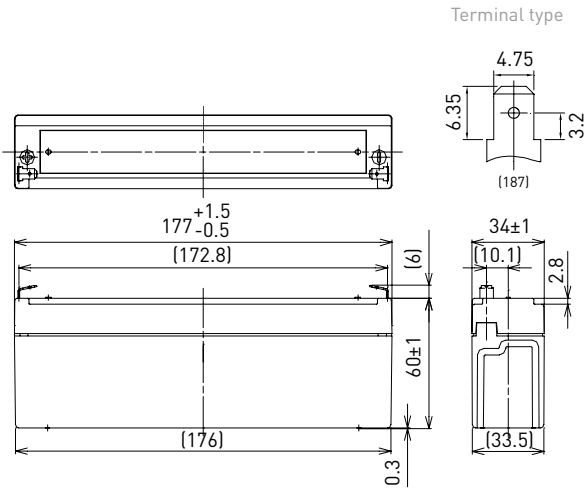

Contents indicated (including the recycle marking, etc.) are subject to change without notice. Battery case resin: standard (UL94 HB)

Specifications		LC-R122R2PG*1
Nominal voltage (V)		12
Nominal capacity	20 hours rate (Ah)	2.2
Dimensions	Length (mm)	34
	Width (mm)	177
	Total height (mm)	66
Approx. mass (kg)		0.80
Terminal type		Faston 187
Capacity (25°C)	20 hours rate (Ah)	2.2
	10 hours rate (Ah)	2.0
	3 hours rate (Ah)	1.8
	1 hour rate (Ah)	1.5
Impedance (mΩ)	Fully charged battery (25°C)	70
	40°C	102
Temperature dependency of capacity (%) - 20 hours rate	25°C	100
	0°C	85
	-15°C	65
	After 3 months (%)	91
Remaining capacity (25°C)	After 6 months (%)	82
	After 12 months (%)	64

DURATION OF DISCHARGE VS. DISCHARGE CURRENT

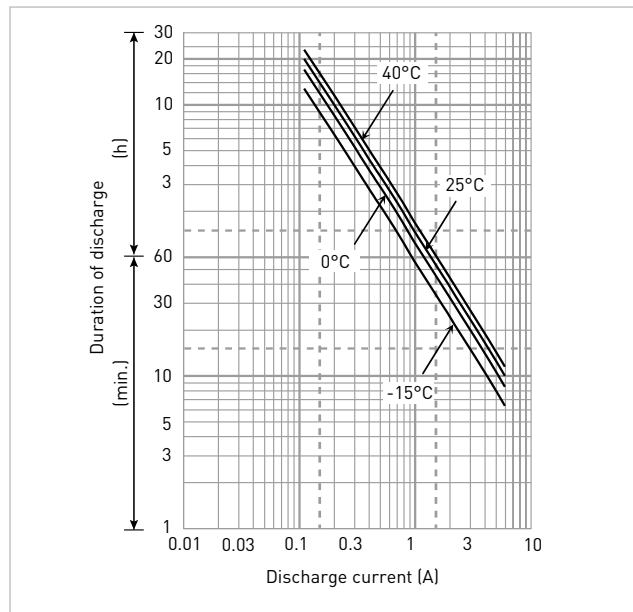

WATT TABLE (25°C)

(Wattage/battery)

Cut-off	3min.	5min.	10min.	15min.	20min.	30min.	45min.	1h	1.5h	2h	3h	4h	5h	6h	10h	20h
9.6V	132	104	68.1	52.0	43.6	32.5	23.0	18.4	12.6	9.77	7.27	5.59	4.61	3.71	2.46	1.33
9.9V	123	97.8	66.7	51.7	42.9	32.2	22.8	18.2	12.4	9.70	7.24	5.55	4.58	3.69	2.45	1.33
10.2V	113	91.6	65.0	50.6	42.2	31.8	22.6	18.0	12.1	9.44	7.16	5.51	4.54	3.66	2.42	1.32
10.5V	101	82.1	60.2	47.1	40.1	31.1	22.2	17.6	11.9	9.12	7.05	5.48	4.50	3.62	2.41	1.32
10.8V	84.9	72.6	53.7	43.9	39.0	30.0	21.9	17.3	11.5	8.68	6.91	5.40	4.39	3.56	2.38	1.31

AMPERE TABLE (25°C)

(Ampere/battery)

Cut-off	3min.	5min.	10min.	15min.	20min.	30min.	45min.	1h	1.5h	2h	3h	4h	5h	6h	10h	20h
9.6V	11.9	9.35	6.08	4.52	3.76	2.78	1.96	1.56	1.07	0.825	0.611	0.468	0.385	0.309	0.205	0.111
9.9V	11.0	8.77	5.96	4.49	3.70	2.75	1.94	1.55	1.05	0.819	0.608	0.464	0.382	0.308	0.204	0.111
10.2V	10.2	8.22	5.81	4.40	3.64	2.72	1.93	1.53	1.03	0.798	0.602	0.461	0.379	0.306	0.202	0.110
10.5V	9.04	7.36	5.38	4.09	3.45	2.66	1.89	1.50	1.01	0.770	0.593	0.458	0.376	0.302	0.201	0.110
10.8V	7.64	6.51	4.80	3.82	3.36	2.57	1.86	1.47	0.978	0.733	0.581	0.452	0.367	0.297	0.199	0.109

All mentioned values are average values

*1 This battery is also available with a flame-retardant battery case resin (UL94 V-0): LC-V122R2PG.

LC-R122R2PG*1

CHARGING METHOD (25°C)

Cycle use	Control voltage: 14.5V - 14.9V Initial current: 0.88A or smaller
------------------	---

CUT-OFF VOLTAGE

Discharge current	0.110A - 0.440A	0.440A - 1.10A	1.10A - 2.20A	2.20A - 4.40A	4.40A - 6.60A
Cut-off voltage	10.5V	10.2V	9.9V	9.3V	8.7V

CYCLE LIFE VS. DEPTH OF DISCHARGE (ACC. IEC 61056)

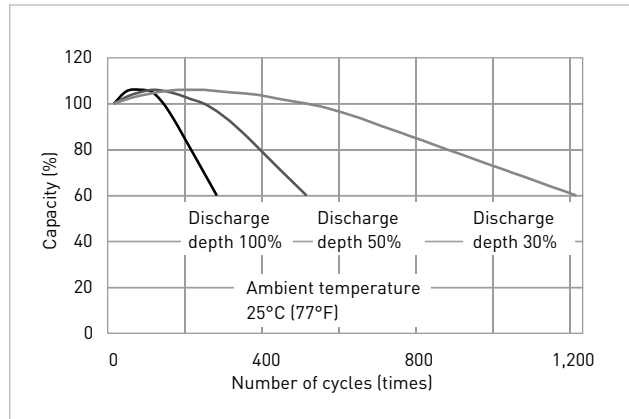

RESIDUAL CAPACITY TEST RESULT

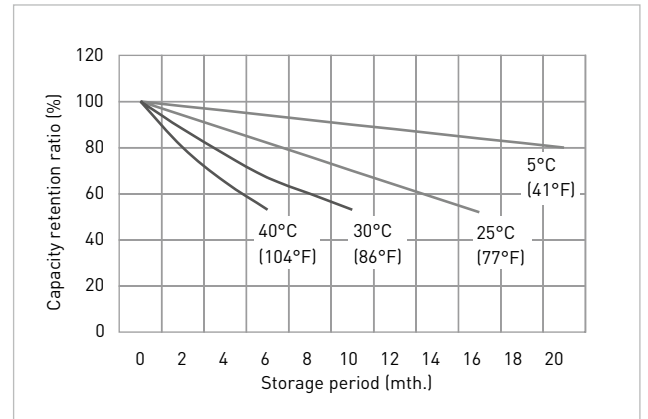

CONSTANT-VOLTAGE CONSTANT-CURRENT CHARGE CHARACTERISTICS FOR CYCLE USE

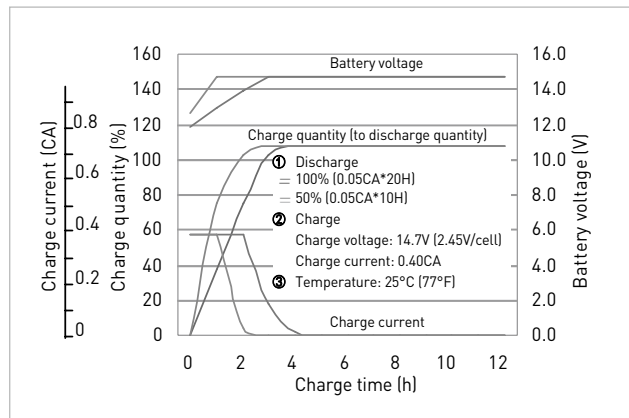

DISCHARGE CAPACITY BY TEMPERATURE AND BY DISCHARGE CURRENT

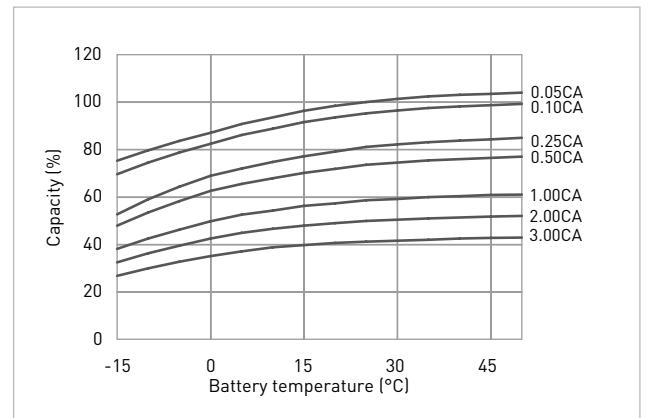

DISCHARGE CHARACTERISTICS

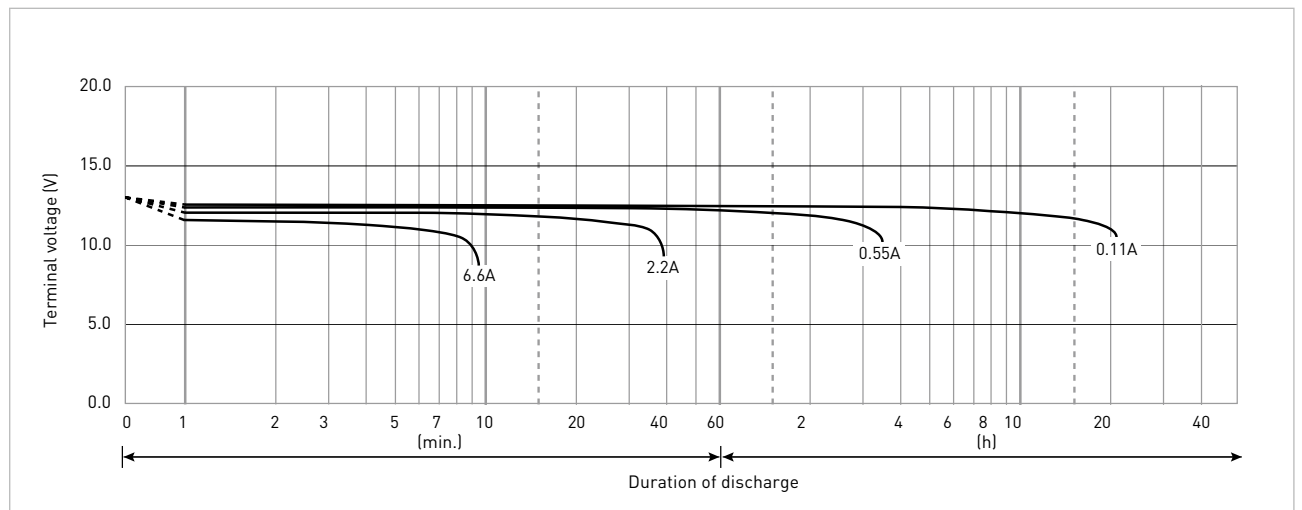

*1 This battery is also available with a flame-retardant battery case resin (UL94 V-0): LC-V122R2PG.

LC-R123R4PG*1

FOR MAIN AND STANDBY POWER SUPPLIES.
EXPECTED TRICKLE DESIGN LIFE: 6 - 9 YEARS
AT 20°C ACCORDING TO EUROBAT.



G191053

DIMENSIONS (MM)



Terminal type

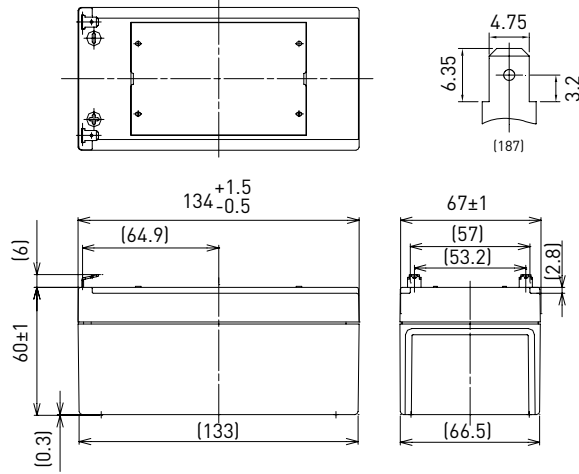

Contents indicated (including the recycle marking, etc.) are subject to change without notice. Battery case resin: standard (UL94 HB)

Specifications		LC-R123R4PG*1
Nominal voltage [V]		12
Nominal capacity	20 hours rate (Ah)	3.4
Dimensions	Length (mm)	67
	Width (mm)	134
	Total height (mm)	66
Approx. mass (kg)		1.15
Terminal type		Faston 187
Capacity [25°C]	20 hours rate (Ah)	3.4
	10 hours rate (Ah)	3.1
	3 hours rate (Ah)	2.8
	1 hour rate (Ah)	2.3
Impedance (mΩ)	Fully charged battery (25°C)	50
	40°C	102
Temperature dependency of capacity (%) - 20 hours rate	25°C	100
	0°C	85
	-15°C	65
	-20°C	55
Remaining capacity [25°C]	After 3 months (%)	91
	After 6 months (%)	82
	After 12 months (%)	64

DURATION OF DISCHARGE VS. DISCHARGE CURRENT

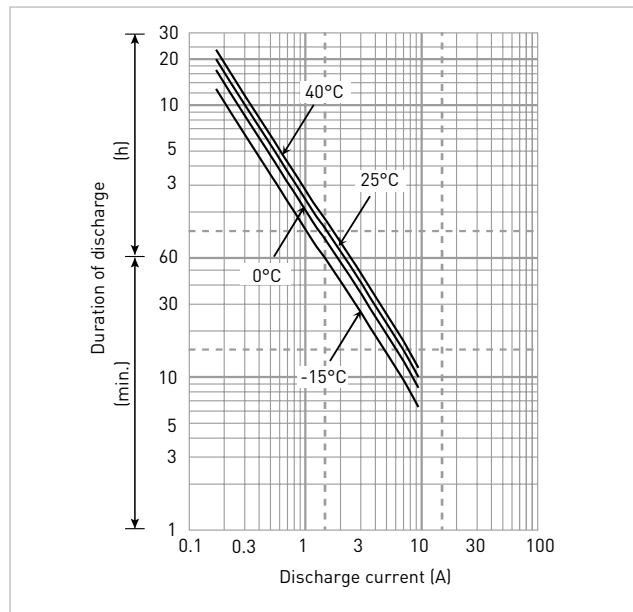

WATT TABLE (25°C)

(Wattage/battery)

Cut-off	3min.	5min.	10min.	15min.	20min.	30min.	45min.	1h	1.5h	2h	3h	4h	5h	6h	10h	20h
9.6V	204	161	105	80.4	67.4	50.3	35.5	28.4	19.6	15.0	11.3	8.63	7.13	5.80	3.81	2.06
9.9V	190	151	103	79.8	66.3	49.7	35.3	28.1	19.2	14.9	11.2	8.58	7.07	5.78	3.80	2.05
10.2V	175	142	100	78.2	65.2	49.2	34.9	27.8	18.8	14.5	11.1	8.52	7.01	5.73	3.76	2.05
10.5V	155	127	93.1	72.8	61.9	48.1	34.4	27.3	18.4	14.0	11.0	8.49	6.96	5.66	3.74	2.04
10.8V	131	112	83.0	67.9	60.3	46.4	33.8	26.7	17.8	13.4	10.7	8.46	6.79	5.66	3.68	1.98

AMPERE TABLE (25°C)

(Ampere/battery)

Cut-off	3min.	5min.	10min.	15min.	20min.	30min.	45min.	1h	1.5h	2h	3h	4h	5h	6h	10h	20h
9.6V	18.4	14.4	9.40	6.99	5.81	4.30	3.02	2.41	1.66	1.26	0.949	0.722	0.595	0.484	0.318	0.171
9.9V	17.0	13.6	9.21	6.94	5.71	4.25	3.00	2.39	1.62	1.24	0.945	0.718	0.590	0.482	0.316	0.171
10.2V	15.7	12.7	8.97	6.80	5.62	4.20	2.97	2.36	1.59	1.22	0.935	0.713	0.586	0.478	0.313	0.170
10.5V	14.0	11.4	8.31	6.33	5.34	4.11	2.93	2.31	1.56	1.18	0.921	0.710	0.581	0.475	0.312	0.170
10.8V	11.8	10.1	7.41	5.90	5.19	3.97	2.88	2.27	1.51	1.13	0.897	0.708	0.567	0.472	0.307	0.165

All mentioned values are average values

*1 This battery is also available with a flame-retardant battery case resin (UL94 V-0): LC-V123R4PG.

LC-R123R4PG*1

CHARGING METHOD (25°C)

Cycle use	Control voltage: 14.5V - 14.9V Initial current: 1.36A or smaller
------------------	---

CUT-OFF VOLTAGE

Discharge current	0.170A - 0.680A	0.680A - 1.70A	1.70A - 3.40A	3.40A - 6.80A	6.80A - 10.2A
Cut-off voltage	10.5V	10.2V	9.9V	9.3V	8.7V

CYCLE LIFE VS. DEPTH OF DISCHARGE (ACC. IEC 61056)

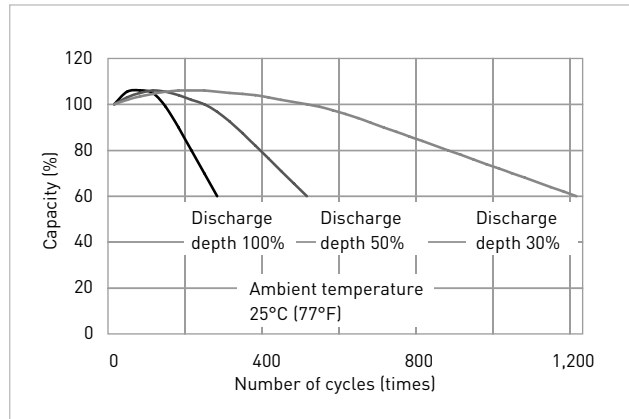

RESIDUAL CAPACITY TEST RESULT

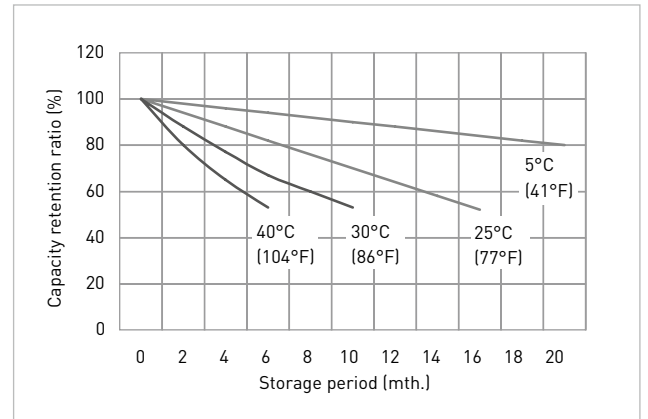

CONSTANT-VOLTAGE CONSTANT-CURRENT CHARGE CHARACTERISTICS FOR CYCLE USE

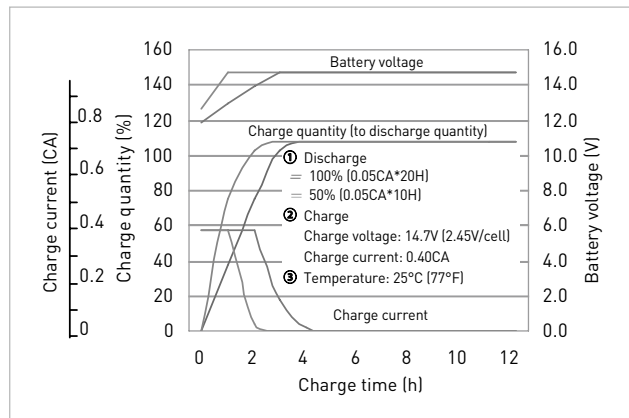

DISCHARGE CAPACITY BY TEMPERATURE AND BY DISCHARGE CURRENT

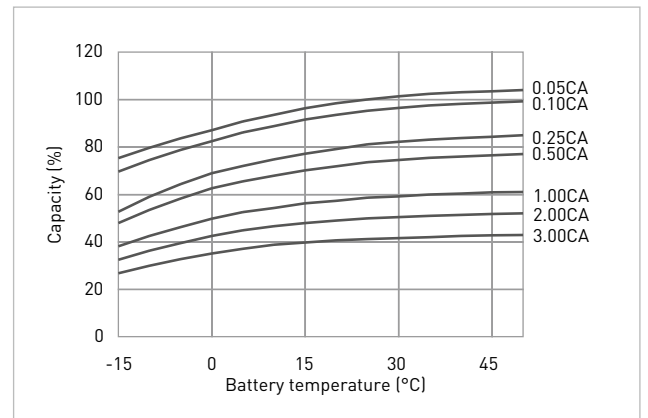

DISCHARGE CHARACTERISTICS

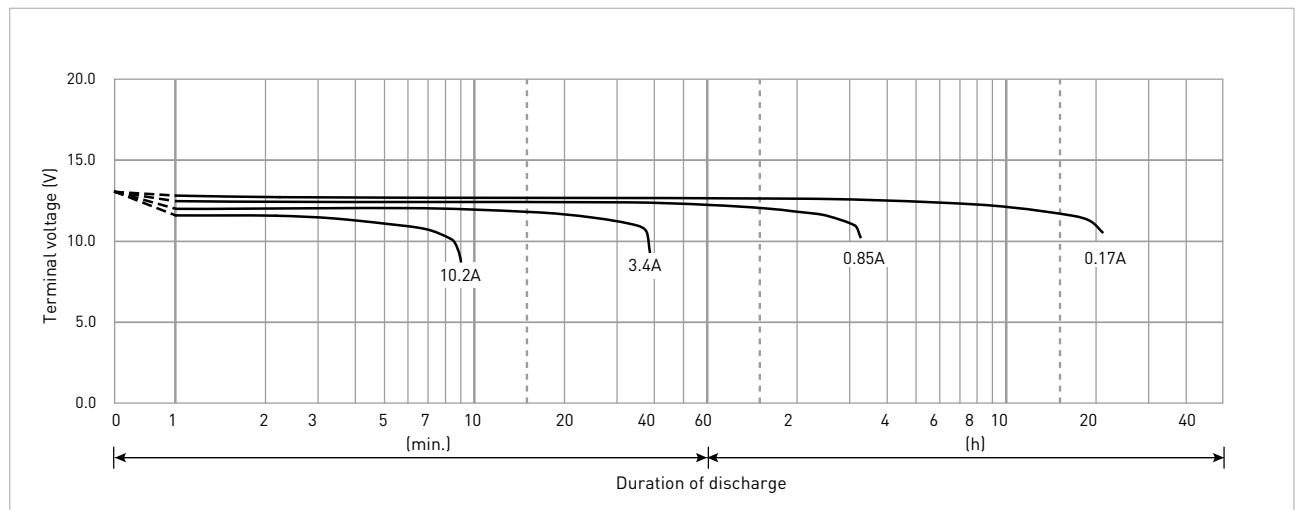

*1 This battery is also available with a flame-retardant battery case resin (UL94 V-0): LC-V123R4PG.

LC-R124R5P*1

FOR MAIN AND STANDBY POWER SUPPLIES.
 EXPECTED TRICKLE DESIGN LIFE: 6 - 9 YEARS AT 20°C
 ACCORDING TO EUROBAT.

DIMENSIONS (MM)



Terminal type

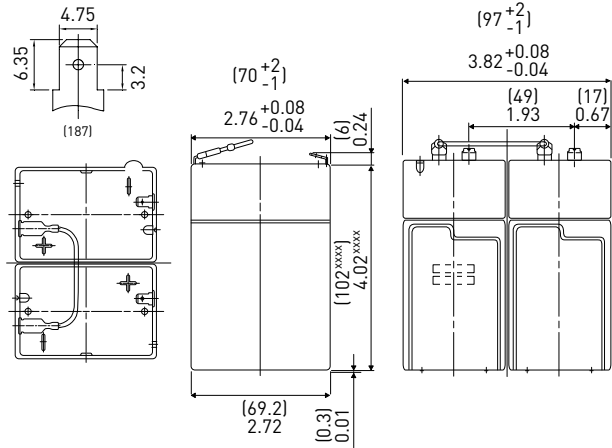

Contents indicated (including the recycle marking, etc.) are subject to change without notice. Battery case resin: standard (UL94 HB)

Specifications		LC-R124R5P*1
Nominal voltage [V]		12
Nominal capacity	20 hours rate [Ah]	4.5
Dimensions	Length [mm]	70
	Width [mm]	97
	Total height [mm]	108
Approx. mass [kg]		1.45
Terminal type		Faston 187
Capacity [25°C]	20 hours rate [Ah]	4.5
	10 hours rate [Ah]	4.1
	3 hours rate [Ah]	3.6
	1 hour rate [Ah]	3.1
Impedance [mΩ]	Fully charged battery [25°C]	40
	Temperature dependency of capacity [%] - 20 hours rate	
	40°C	102
	25°C	100
	0°C	85
	-15°C	65
Remaining capacity [25°C]	After 3 months [%]	91
	After 6 months [%]	82
	After 12 months [%]	64

DURATION OF DISCHARGE VS. DISCHARGE CURRENT

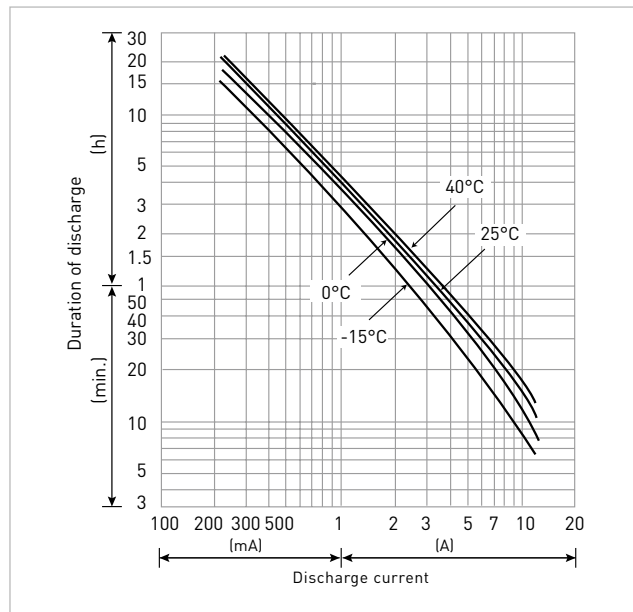

WATT TABLE (25°C)

(Wattage/battery)

Cut-off	3min.	5min.	10min.	15min.	20min.	30min.	45min.	1h	1.5h	2h	3h	4h	5h	6h	10h	20h
9.6V	270	214	139.4	106.4	89.2	66.6	47	37.6	25.8	19.98	14.88	11.42	9.44	7.58	5.02	2.72
9.9V	250	200	136.6	105.6	87.8	65.8	46.6	37.6	25.4	19.84	14.8	11.36	9.36	7.56	5	2.72
10.2V	232	188	133	103.6	86.2	65	46.2	36.8	24.8	19.32	14.66	11.28	9.28	7.5	4.96	2.7
10.5V	206	168	123.2	96.4	82	63.6	45.4	36	24.2	18.64	14.42	11.2	9.2	7.4	4.92	2.7
10.8V	174	148	110	89.8	79.8	61.4	44.8	35.4	23.6	17.76	14.14	11.06	8.98	7.28	4.88	2.68

AMPERE TABLE (25°C)

(Ampere/battery)

Cut-off	3min.	5min.	10min.	15min.	20min.	30min.	45min.	1h	1.5h	2h	3h	4h	5h	6h	10h	20h
9.6V	24.3	19.13	12.44	9.25	7.69	5.69	4.00	3.19	2.19	1.69	1.25	0.956	0.788	0.633	0.419	0.227
9.9V	22.6	17.94	12.19	9.19	7.56	5.63	3.98	3.19	2.14	1.68	1.24	0.950	0.781	0.630	0.417	0.226
10.2V	20.8	16.81	11.88	9.00	7.44	5.56	3.94	3.13	2.10	1.63	1.23	0.944	0.775	0.625	0.413	0.226
10.5V	18.5	15.06	11.00	8.38	7.06	5.44	3.88	3.06	2.06	1.58	1.21	0.938	0.769	0.618	0.411	0.225
10.8V	15.6	13.31	9.81	7.81	6.88	5.25	3.81	3.00	2.00	1.50	1.19	0.925	0.750	0.608	0.406	0.224

All mentioned values are average values

*1 This battery is also available with a flame-retardant battery case resin (UL94 V-0): LC-V124R5P.

LC-R124R5P*1

CHARGING METHOD (25°C)

Cycle use	Control voltage: 14.5V - 14.9V Initial current: 1.80A or smaller
------------------	---

CUT-OFF VOLTAGE

Discharge current	0.225A - 0.9A	0.9A - 2.25A	2.25A - 4.5A	4.5A - 9.0A	9.0A - 13.5A
Cut-off voltage	10.5V	10.2V	9.9V	9.3V	8.7V

CYCLE LIFE VS. DEPTH OF DISCHARGE (ACC. IEC 61056)

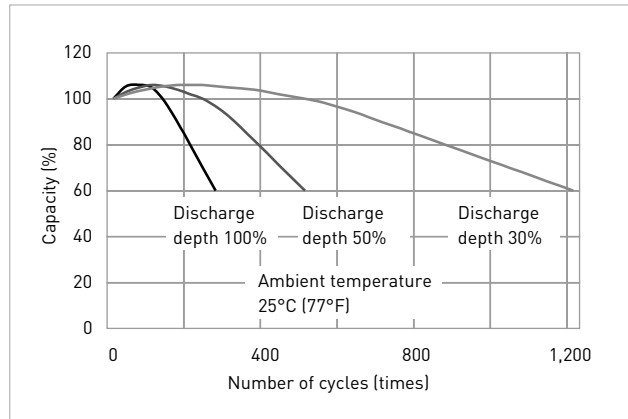

RESIDUAL CAPACITY TEST RESULT

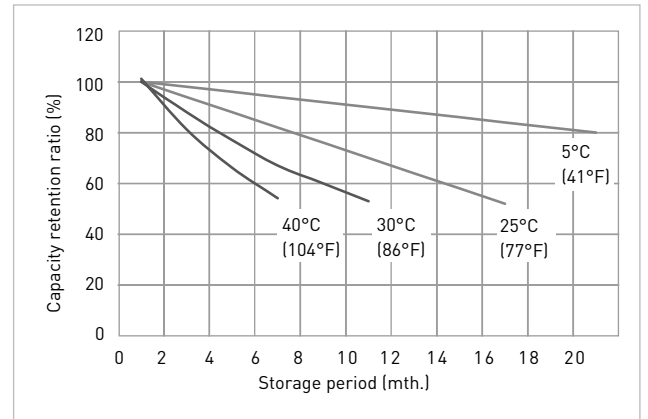

CONSTANT-VOLTAGE CONSTANT-CURRENT CHARGE CHARACTERISTICS FOR CYCLE USE

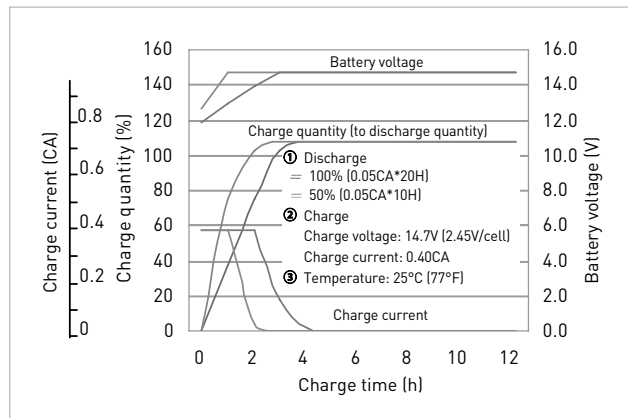

DISCHARGE CAPACITY BY TEMPERATURE AND BY DISCHARGE CURRENT

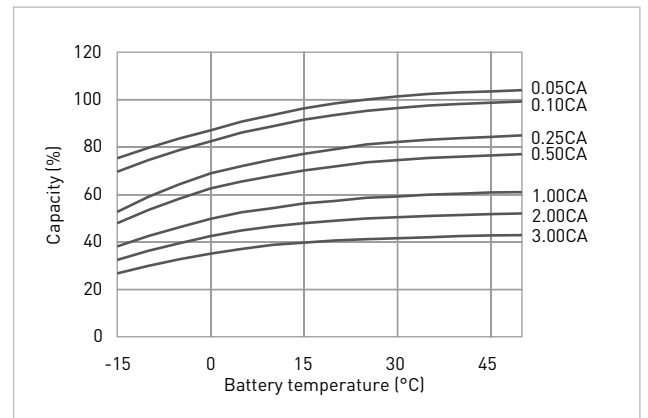

DISCHARGE CHARACTERISTICS

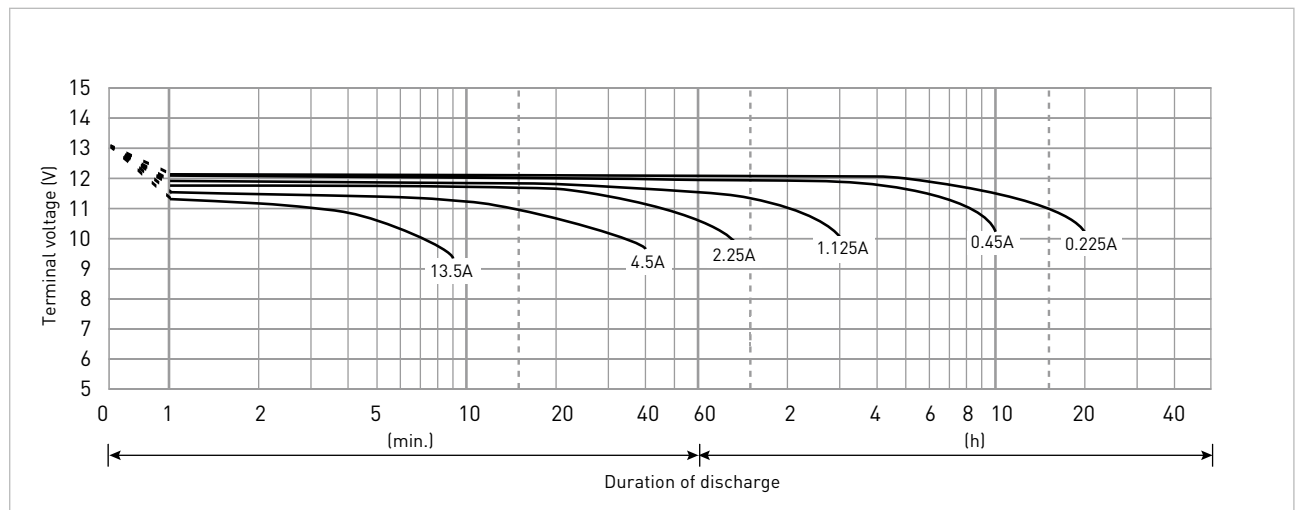

*1 This battery is also available with a flame-retardant battery case resin (UL94 V-0): LC-V124R5P.

LC-R127R2PG/PG1*1

FOR MAIN AND STANDBY POWER SUPPLIES.
 EXPECTED TRICKLE DESIGN LIFE: 6 - 9 YEARS
 AT 20°C ACCORDING TO EUROBAT.



G193046

DIMENSIONS (MM)

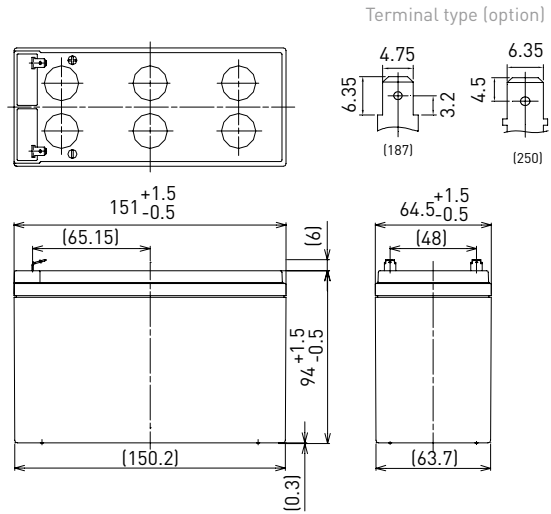

Contents indicated (including the recycle marking, etc.) are subject to change without notice. Battery case resin: standard (UL94 HB)

Specifications		LC-R127R2PG/PG1*1
Nominal voltage (V)		12
Nominal capacity	20 hours rate (Ah)	7.2
Dimensions	Length (mm)	64.5
	Width (mm)	151
	Total height (mm)	100
Approx. mass (kg)		2.50
Terminal type		Faston 187/250
Capacity (25°C)	20 hours rate (Ah)	7.2
	10 hours rate (Ah)	6.6
	3 hours rate (Ah)	5.8
	1 hour rate (Ah)	4.9
Impedance (mΩ)	Fully charged battery (25°C)	21
Temperature dependency of capacity (%) - 20 hours rate	40°C	102
	25°C	100
	0°C	85
	-15°C	65
Remaining capacity (25°C)	After 3 months (%)	91
	After 6 months (%)	82
	After 12 months (%)	64

DURATION OF DISCHARGE VS. DISCHARGE CURRENT

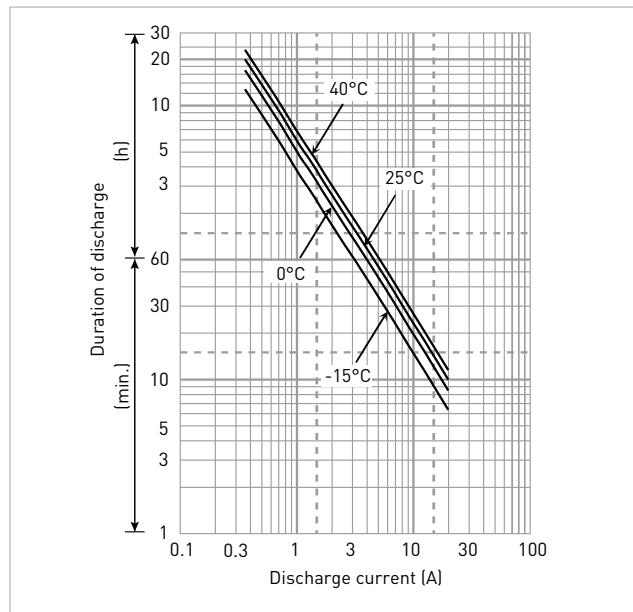

WATT TABLE (25°C)

(Wattage/battery)

Cut-off	3min.	5min.	10min.	15min.	20min.	30min.	45min.	1h	1.5h	2h	3h	4h	5h	6h	10h	20h
9.6V	430	335	220	167	134	98.4	72.1	56.5	44.6	34.7	24.7	19.2	15.4	12.8	8.39	4.60
9.9V	405	287	187	159	130	96.4	71.6	55.1	43.7	34.4	24.5	19.1	15.3	12.5	8.35	4.59
10.2V	379	273	182	151	126	94.3	68.6	53.6	41.4	32.5	23.5	18.7	14.6	12.2	8.00	4.43
10.5V	343	248	174	144	120	90.8	66.8	52.4	39.8	31.5	23.0	18.3	14.5	12.1	7.96	4.42
10.8V	308	223	164	138	115	87.2	62.6	48.4	37.2	28.1	21.4	16.9	13.3	11.2	7.41	4.13

AMPERE TABLE (25°C)

(Ampere/battery)

Cut-off	3min.	5min.	10min.	15min.	20min.	30min.	45min.	1h	1.5h	2h	3h	4h	5h	6h	10h	20h
9.6V	38.9	30.6	19.9	14.8	12.3	9.10	6.40	5.10	3.50	2.70	2.00	1.53	1.26	1.02	0.670	0.363
9.9V	36.1	28.7	19.5	14.7	12.1	9.00	6.36	5.05	3.43	2.68	1.99	1.52	1.25	1.01	0.667	0.362
10.2V	34.2	26.9	19.0	14.4	11.9	8.90	6.30	5.00	3.36	2.61	1.97	1.51	1.24	1.00	0.660	0.361
10.5V	31.4	24.1	17.6	13.4	11.3	8.70	6.20	4.90	3.29	2.52	1.94	1.50	1.23	0.988	0.657	0.360
10.8V	29.0	22.3	15.7	12.5	11.0	8.40	6.10	4.80	3.20	2.40	1.90	1.48	1.20	0.972	0.650	0.358

All mentioned values are average values

*1 This battery is also available with a flame-retardant battery case resin (UL94 V-0): LC-V127R2PG/PG1.

LC-R127R2PG/PG1*1

CHARGING METHOD (25°C)

Cycle use	Control voltage: 14.5V - 14.9V Initial current: 2.88A or smaller
------------------	---

CUT-OFF VOLTAGE

Discharge current	0.360A - 1.44A	1.44A - 3.60A	3.60A - 7.20A	7.20A - 14.4A	14.4A - 21.6A
Cut-off voltage	10.5V	10.2V	9.9V	9.3V	8.7V

CYCLE LIFE VS. DEPTH OF DISCHARGE (ACC. IEC 61056)

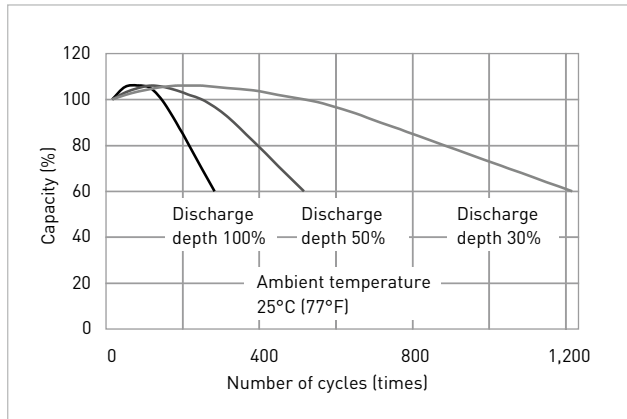

RESIDUAL CAPACITY TEST RESULT

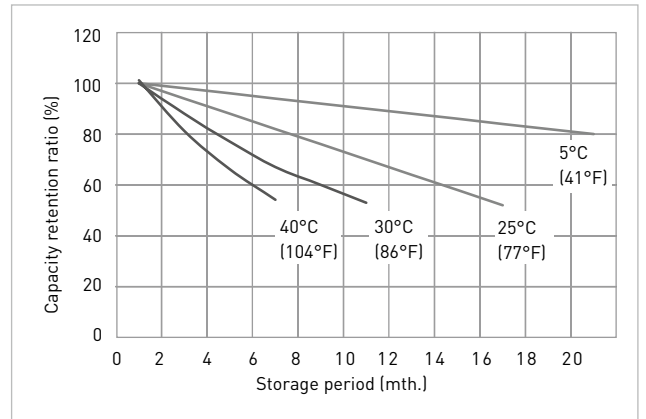

CONSTANT-VOLTAGE CONSTANT-CURRENT CHARGE CHARACTERISTICS FOR CYCLE USE

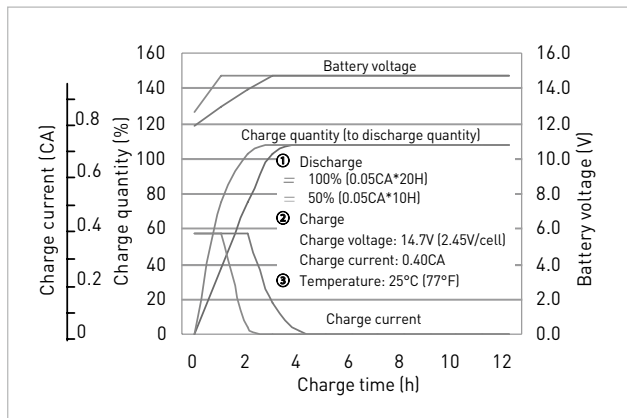

DISCHARGE CAPACITY BY TEMPERATURE AND BY DISCHARGE CURRENT

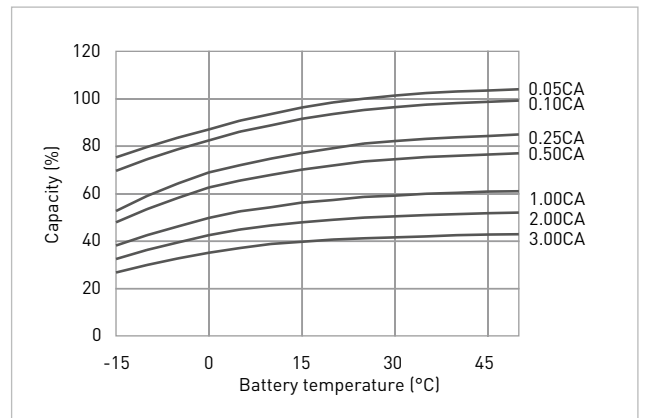

DISCHARGE CHARACTERISTICS

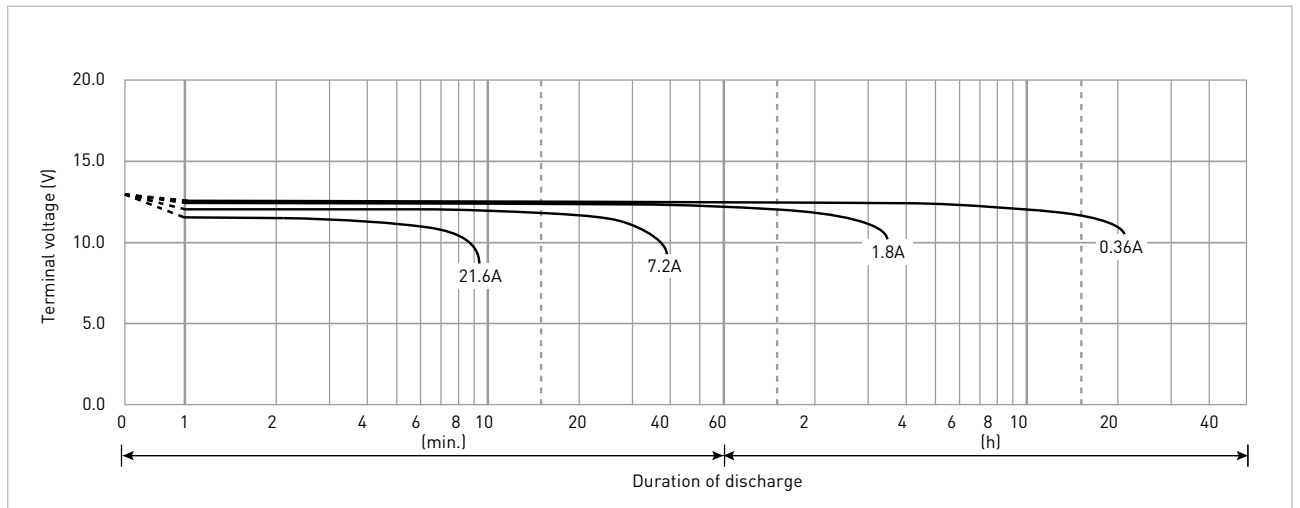

*1 This battery is also available with a flame-retardant battery case resin (UL94 V-0): LC-V127R2PG/PG1.

LC-RA1212PG/PG1*1

FOR MAIN AND STANDBY POWER SUPPLIES.
 EXPECTED TRICKLE DESIGN LIFE: 6 - 9 YEARS
 AT 20°C ACCORDING TO EUROBAT.



G100001

DIMENSIONS (MM)

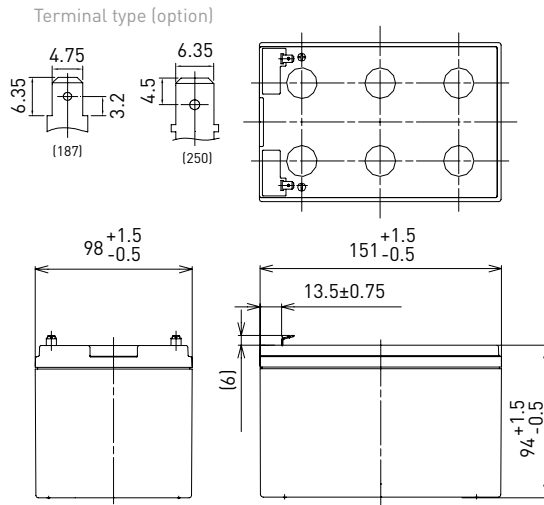

Contents indicated (including the recycle marking, etc.) are subject to change without notice. Battery case resin: standard (UL94 HB)

Specifications		LC-RA1212PG/PG1*1
Nominal voltage (V)		12
Nominal capacity	20 hours rate (Ah)	12.0
Dimensions	Length (mm)	98
	Width (mm)	151
	Total height (mm)	100
Approx. mass (kg)		3.80
Terminal type		Faston 187/250
Capacity (25°C)	20 hours rate (Ah)	12.0
	10 hours rate (Ah)	11.0
	3 hours rate (Ah)	9.3
	1 hour rate (Ah)	8.5
Impedance (mΩ)	Fully charged battery (25°C)	15
	Temperature dependency of capacity (%) - 20 hours rate	
	40°C	102
	25°C	100
	0°C	85
	-15°C	65
Remaining capacity (25°C)	After 3 months (%)	91
	After 6 months (%)	82
	After 12 months (%)	64

DURATION OF DISCHARGE VS. DISCHARGE CURRENT

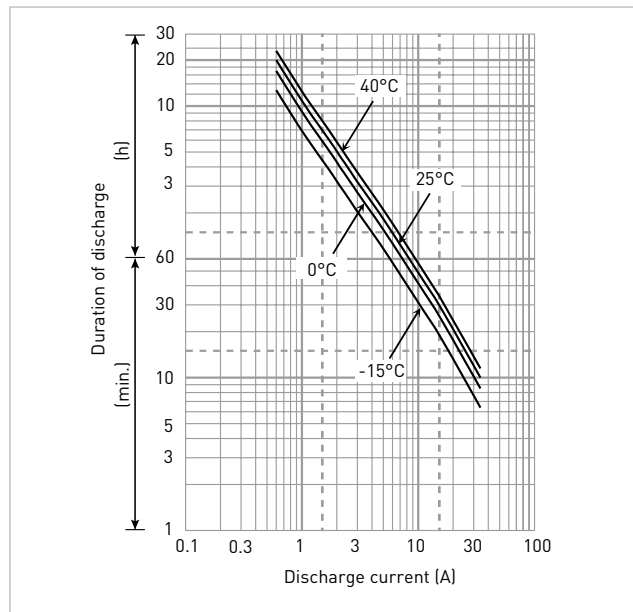

WATT TABLE (25°C)

(Wattage/battery)

Cut-off	3min.	5min.	10min.	15min.	20min.	30min.	45min.	1h	1.5h	2h	3h	4h	5h	6h	10h	20h
9.6V	679	559	384	298	247	183	137	105	70.3	54.5	38.1	28.8	24.1	21.7	13.3	7.22
9.9V	649	537	373	288	241	177	135	104	69.9	54.2	37.8	28.7	24.0	21.7	13.3	7.22
10.2V	607	506	363	282	235	175	134	102	69.1	53.9	37.5	28.6	23.9	21.6	13.2	7.21
10.5V	556	475	343	271	231	172	133	100	68.5	53.3	36.9	28.5	23.8	21.6	13.2	7.20
10.8V	495	434	321	261	225	166	123	97.8	66.1	52.1	36.3	28.4	23.7	21.5	13.1	7.18

AMPERE TABLE (25°C)

(Ampere/battery)

Cut-off	3min.	5min.	10min.	15min.	20min.	30min.	45min.	1h	1.5h	2h	3h	4h	5h	6h	10h	20h
9.6V	61.1	50.1	34.3	25.9	21.3	15.6	11.7	8.90	5.95	4.60	3.20	2.41	2.01	1.81	1.11	0.602
9.9V	58.4	48.2	33.3	25.0	20.8	15.1	11.5	8.80	5.92	4.58	3.18	2.40	2.01	1.81	1.11	0.602
10.2V	54.6	45.4	32.4	24.5	20.3	14.9	11.4	8.70	5.85	4.55	3.15	2.39	2.00	1.80	1.10	0.601
10.5V	50.0	42.6	30.6	23.6	19.9	14.7	11.3	8.50	5.80	4.50	3.10	2.38	2.00	1.80	1.10	0.600
10.8V	44.5	38.9	28.7	22.7	19.4	14.2	10.5	8.30	5.60	4.40	3.05	2.37	1.99	1.79	1.09	0.598

All mentioned values are average values

*1 This battery is also available with a flame-retardant battery case resin (UL94 V-0): LC-VA1212PG/PG1.

LC-RA1212PG/PG1*1

CHARGING METHOD (25°C)

Cycle use	Control voltage: 14.5V - 14.9V Initial current: 4.80A or smaller
------------------	---

CUT-OFF VOLTAGE

Discharge current	0.600A - 2.40A	2.40A - 6.00A	6.00A - 12.0A	12.0A - 24.0A	24.0A - 36.0A
Cut-off voltage	10.5V	10.2V	9.9V	9.3V	8.7V

CYCLE LIFE VS. DEPTH OF DISCHARGE (ACC. IEC 61056)

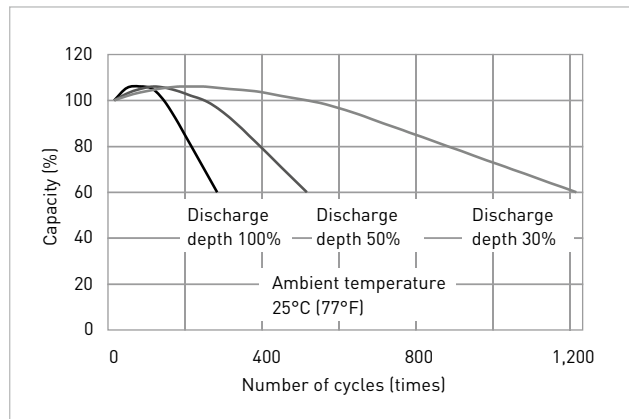

RESIDUAL CAPACITY TEST RESULT

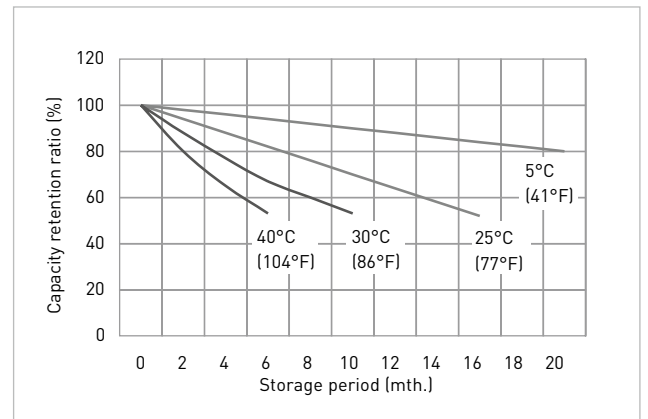

CONSTANT-VOLTAGE CONSTANT-CURRENT CHARGE CHARACTERISTICS FOR CYCLE USE

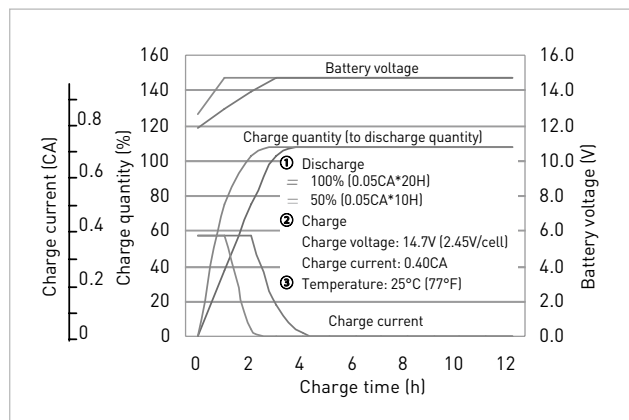

DISCHARGE CAPACITY BY TEMPERATURE AND BY DISCHARGE CURRENT

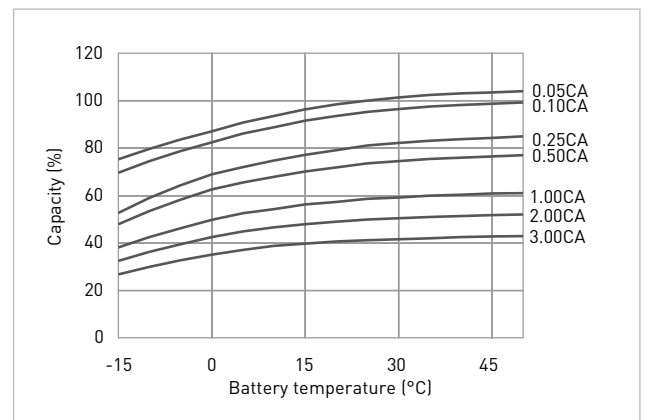

DISCHARGE CHARACTERISTICS

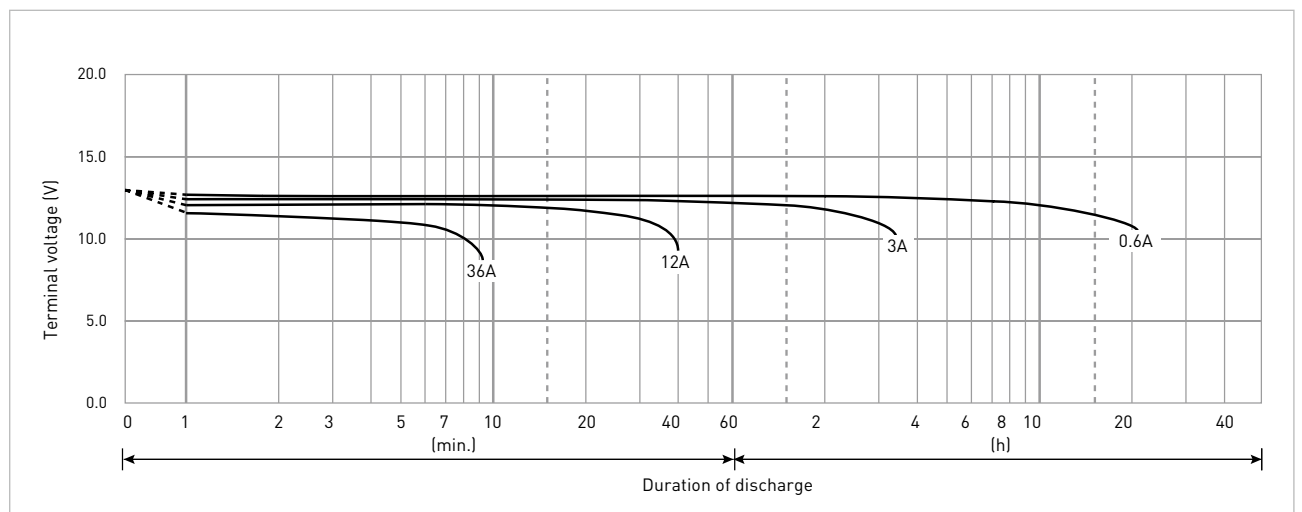

*1 This battery is also available with a flame-retardant battery case resin (UL94 V-0): LC-VA1212PG/PG1.

LC-RA1215P/P1*1

FOR MAIN AND STANDBY POWER SUPPLIES.
 EXPECTED TRICKLE DESIGN LIFE: 6 - 9 YEARS AT 20°C
 ACCORDING TO EUROBAT.

DIMENSIONS (MM)

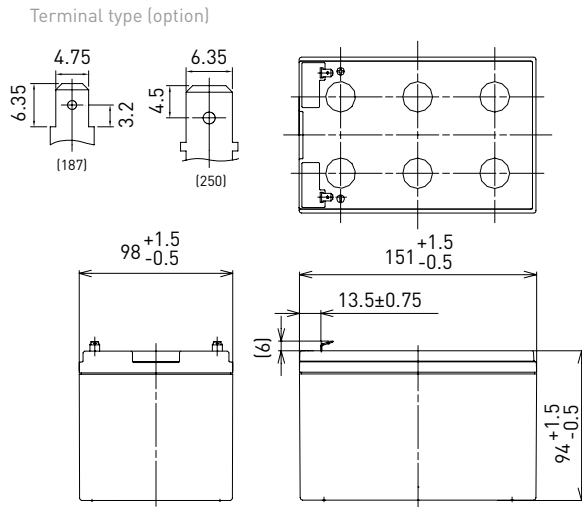

Contents indicated (including the recycle marking, etc.) are subject to change without notice. Battery case resin: standard (UL94 HB)

Specifications		LC-RA1215P/P1*1
Nominal voltage (V)		12
Nominal capacity	20 hours rate (Ah)	15.0
Dimensions	Length (mm)	98
	Width (mm)	151
	Total height (mm)	100
Approx. mass (kg)		4.15
Terminal type		Faston 187/250
Capacity (25°C)	20 hours rate (Ah)	15.0
	10 hours rate (Ah)	13.0
	3 hours rate (Ah)	12.0
	1 hour rate (Ah)	10.0
Impedance (mΩ)	Fully charged battery (25°C)	15
	Temperature dependency of capacity (%) - 20 hours rate	
	40°C	102
	25°C	100
	0°C	85
	-15°C	65
Remaining capacity (25°C)	After 3 months (%)	91
	After 6 months (%)	82
	After 12 months (%)	64

DURATION OF DISCHARGE VS. DISCHARGE CURRENT

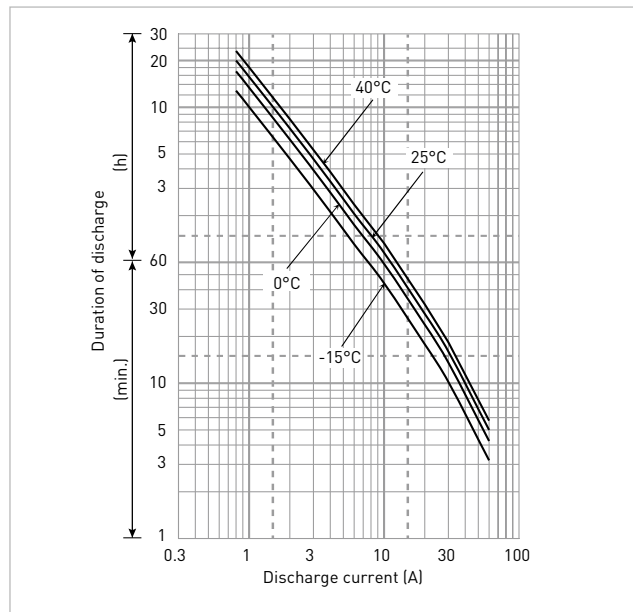

WATT TABLE (25°C)

(Wattage/battery)

Cut-off	3min.	5min.	10min.	15min.	20min.	30min.	45min.	1h	1.5h	2h	3h	4h	5h	6h	10h	20h
9.6V	850	682	455	350	292	217	157	123	83.9	65.0	47.1	36.0	29.9	25.2	16.2	8.75
9.9V	799	646	444	343	286	213	156	122	82.8	64.6	46.9	35.8	29.7	25.1	16.1	8.74
10.2V	741	607	433	336	281	211	154	121	81.4	63.4	46.4	35.7	29.5	24.9	15.9	8.72
10.5V	667	555	404	318	270	206	152	118	80.1	61.9	45.7	35.5	29.4	24.8	15.8	8.70
10.8V	576	497	368	300	263	199	146	116	77.7	59.6	44.8	35.1	28.9	24.5	15.7	8.66

AMPERE TABLE (25°C)

(Ampere/battery)

Cut-off	3min.	5min.	10min.	15min.	20min.	30min.	45min.	1h	1.5h	2h	3h	4h	5h	6h	10h	20h
9.6V	76.5	61.2	40.6	30.4	25.2	18.5	13.4	10.50	7.11	5.49	3.96	3.01	2.49	2.10	1.35	0.755
9.9V	71.8	58.0	39.7	29.9	24.7	18.2	13.3	10.40	7.01	5.45	3.94	3.00	2.48	2.09	1.34	0.753
10.2V	66.6	54.5	38.6	29.2	24.2	18.1	13.1	10.30	6.89	5.36	3.90	2.99	2.46	2.08	1.33	0.752
10.5V	59.9	49.8	36.1	27.6	23.3	17.6	13.0	10.00	6.78	5.22	3.84	2.97	2.45	2.07	1.32	0.750
10.8V	51.8	44.6	32.9	26.1	22.7	17.0	12.5	9.82	6.58	5.03	3.77	2.94	2.41	2.04	1.31	0.747

All mentioned values are average values

*1 This battery is also available with a flame-retardant battery case resin (UL94 V-0): LC-VA1215P/P1.

LC-RA1215P/P1*1

CHARGING METHOD (25°C)

Cycle use	Control voltage: 14.5V - 14.9V Initial current: 6A or smaller
------------------	--

CUT-OFF VOLTAGE

Discharge current	0.75A - 3A	3A - 7.5A	7.5A - 15A	15A - 30A	30A - 45A
Cut-off voltage	10.5V	10.2V	9.9V	9.3V	8.7V

CYCLE LIFE VS. DEPTH OF DISCHARGE (ACC. IEC 61056)

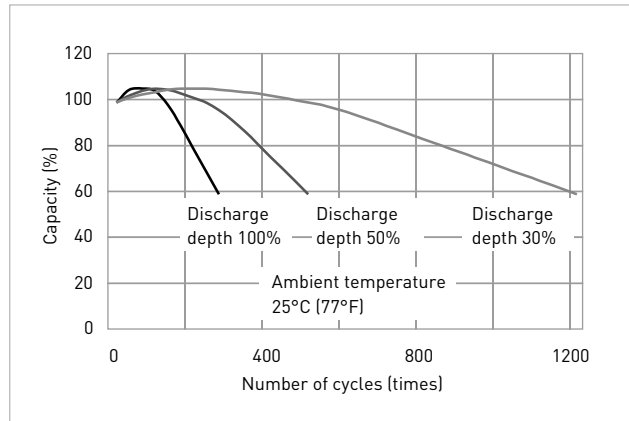

RESIDUAL CAPACITY TEST RESULT

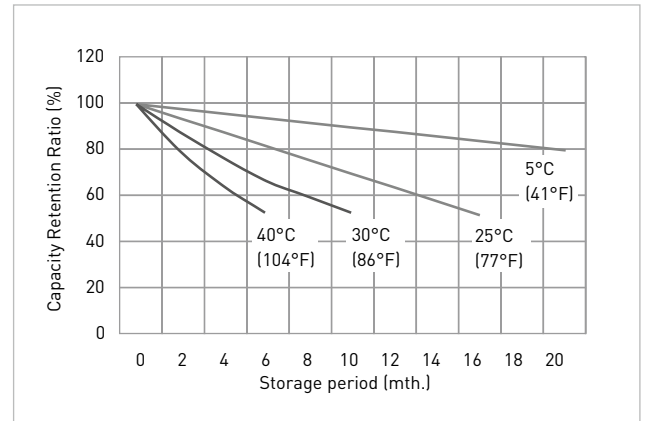

CONSTANT-VOLTAGE CONSTANT-CURRENT CHARGE CHARACTERISTICS FOR CYCLE USE

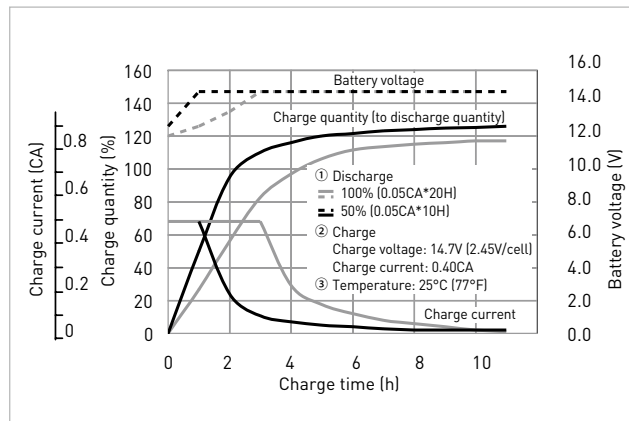

DISCHARGE CAPACITY BY TEMPERATURE AND BY DISCHARGE CURRENT

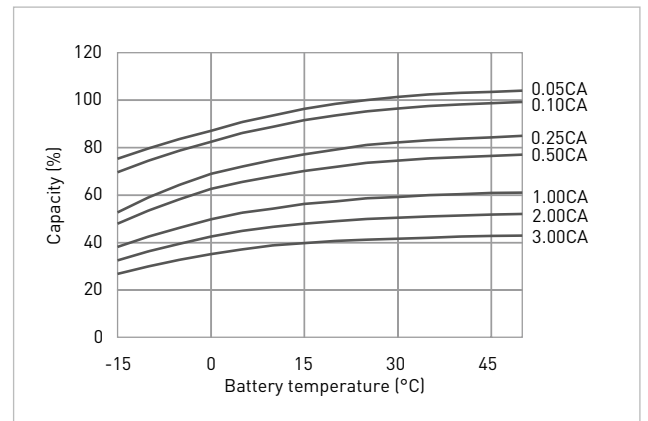

DISCHARGE CHARACTERISTICS

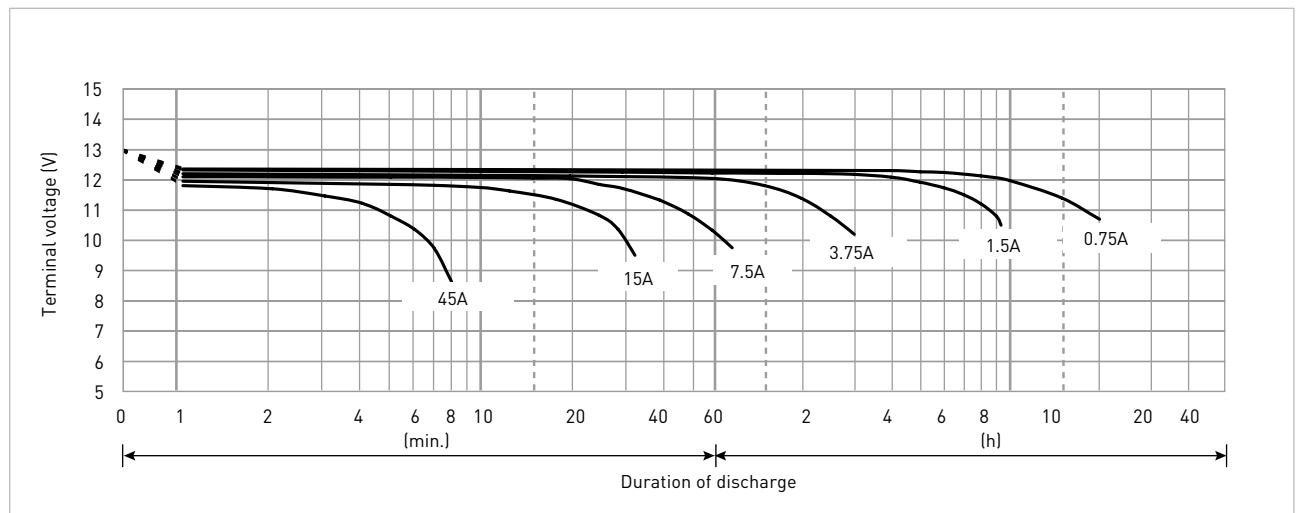

*1 This battery is also available with a flame-retardant battery case resin (UL94 V-0): LC-VA1215P/P1.

LC-V1233P

FOR MAIN AND STANDBY POWER SUPPLIES.
 EXPECTED TRICKLE DESIGN LIFE: 6 - 9 YEARS AT 20°C
 ACCORDING TO EUROBAT.

DIMENSIONS (MM)



Contents indicated (including the recycle marking, etc.) are subject to change without notice. Battery case resin: flame-retardant (UL94 V-0)

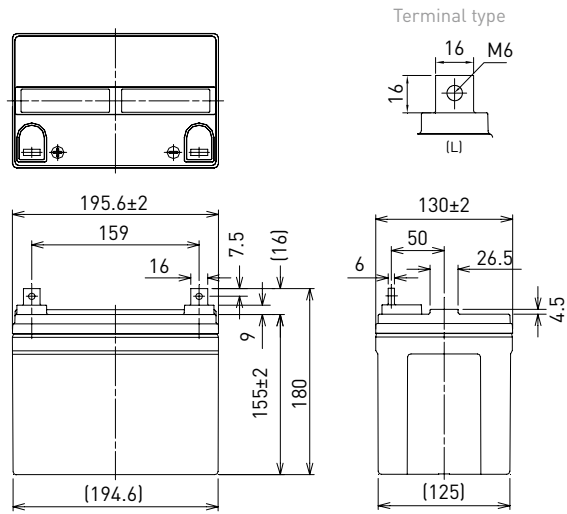

Specifications		LC-V1233P
Nominal voltage (V)		12
Nominal capacity	20 hours rate (Ah)	33.0
Dimensions	Length (mm)	130
	Width (mm)	195.6
	Total height (mm)	180
Approx. mass (kg)		11.5
Terminal type		M6 bolt/nut
Capacity (25°C)	20 hours rate (Ah)	33.0
	10 hours rate (Ah)	31.0
	3 hours rate (Ah)	26.0
	1 hour rate (Ah)	22.0
Impedance (mΩ)	Fully charged battery (25°C)	7
Temperature dependency of capacity (%) - 20 hours rate	40°C	102
	25°C	100
	0°C	85
	-15°C	65
Remaining capacity (25°C)	After 3 months (%)	91
	After 6 months (%)	82
	After 12 months (%)	64

DURATION OF DISCHARGE VS. DISCHARGE CURRENT

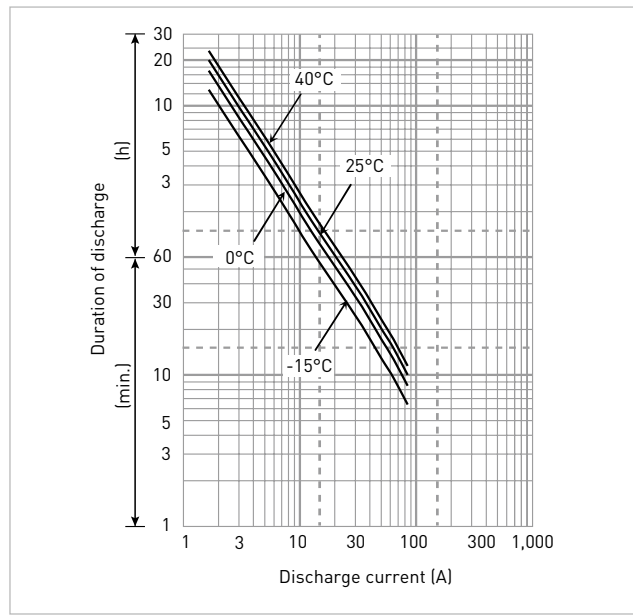

WATT TABLE (25°C)

(Wattage/battery)

Cut-off	5min.	10min.	15min.	20min.	30min.	45min.	1h	1.5h	2h	3h	4h	5h	6h	10h	20h
9.6V	1,254	948	732	635	457	328	268	187	149	107	86.6	69.5	60.5	36.9	19.8
9.9V	1,182	928	721	630	452	322	262	182	148	106	85.4	68.3	60.1	36.9	19.8
10.2V	1,115	899	706	619	443	321	259	170	147	105	84.2	67.7	59.7	36.9	19.8
10.5V	1,051	868	684	603	433	314	256	168	146	104	83.6	67.4	59.2	36.9	19.8
10.8V	1,001	823	663	590	421	281	233	162	137	99.4	82.5	67.1	58.8	36.9	19.8

AMPERE TABLE (25°C)

(Ampere/battery)

Cut-off	5min.	10min.	15min.	20min.	30min.	45min.	1h	1.5h	2h	3h	4h	5h	6h	10h	20h
9.6V	113	84.6	63.7	54.8	39.1	27.9	22.8	15.8	12.6	9.00	7.25	5.80	5.10	3.10	1.65
9.9V	106	82.9	62.7	54.4	38.6	27.4	22.2	15.5	12.5	8.85	7.15	5.70	5.05	3.10	1.65
10.2V	100	80.3	61.4	53.4	37.9	27.1	22.0	14.4	12.4	8.75	7.05	5.65	5.00	3.10	1.65
10.5V	94.3	77.5	59.5	52.0	37.0	26.8	21.8	14.3	12.3	8.70	6.98	5.63	4.95	3.10	1.65
10.8V	89.8	73.5	57.7	50.9	36.0	24.0	19.8	13.7	11.6	8.35	6.90	5.60	4.90	3.10	1.65

All mentioned values are average values

LC-V1233P

CHARGING METHOD (25°C)

Cycle use	Control voltage: 13.6V - 13.8V Initial current: 4.95A or smaller
------------------	---

CUT-OFF VOLTAGE

Discharge current	1.65A - 6.60A	6.60A - 16.5A	16.5A - 33.0A	33.0A - 66.0A	66.0A - 99.0A
Cut-off voltage	10.5V	10.2V	9.9V	9.3V	8.7V

INFLUENCE OF TEMPERATURE ON TRICKLE LIFE

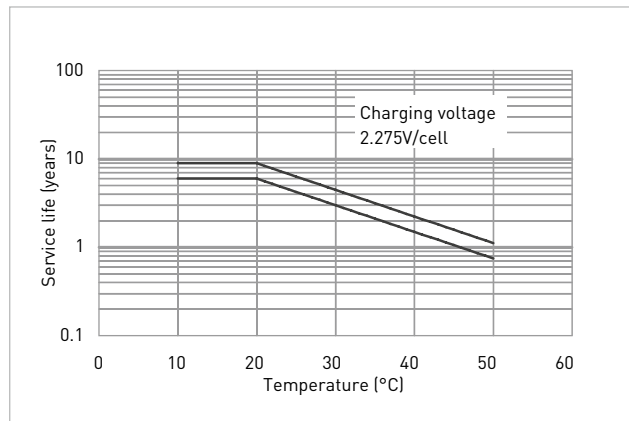

RESIDUAL CAPACITY TEST RESULT

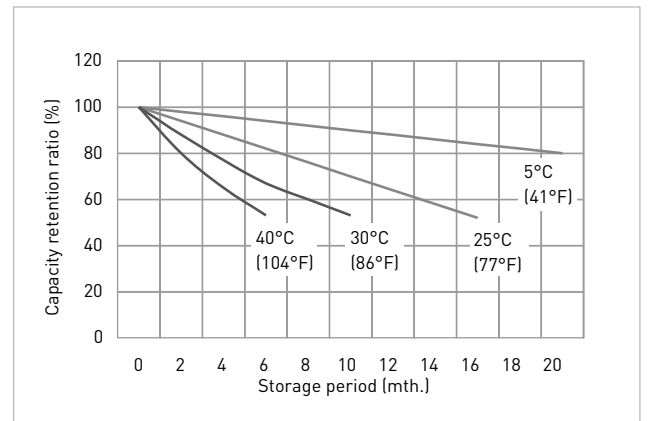

CONSTANT-VOLTAGE CONSTANT-CURRENT CHARGE CHARACTERISTICS FOR CYCLE USE

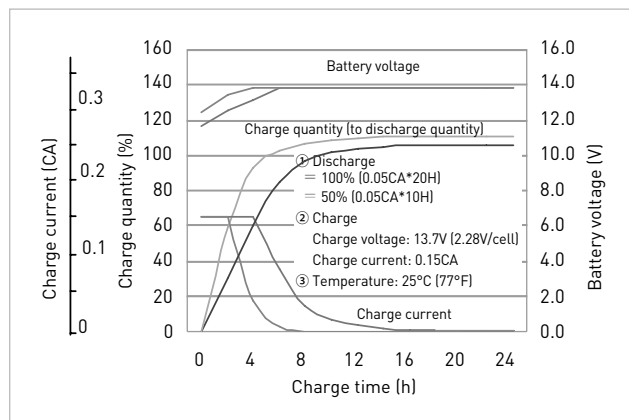

DISCHARGE CAPACITY BY TEMPERATURE AND BY DISCHARGE CURRENT

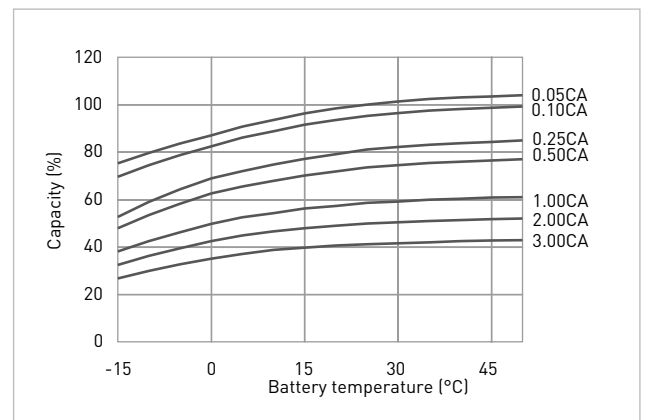

DISCHARGE CHARACTERISTICS

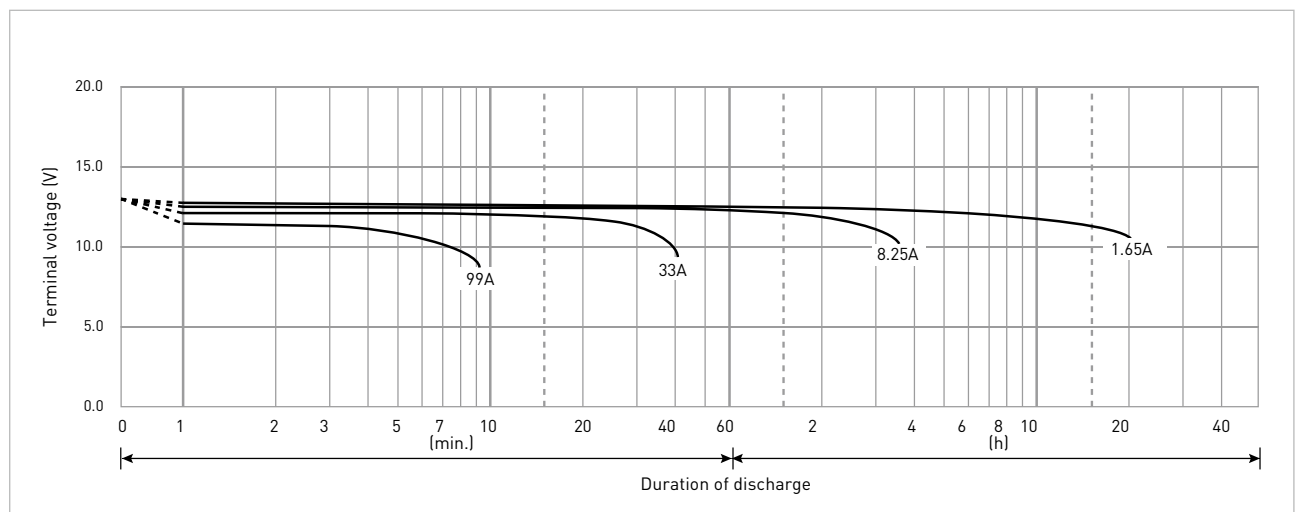

LC-P067R2P/P1

FOR STANDBY POWER SUPPLIES.
 EXPECTED TRICKLE DESIGN LIFE: 10 – 12 YEARS AT 20°C
 ACCORDING TO EUROBAT.

DIMENSIONS (MM)

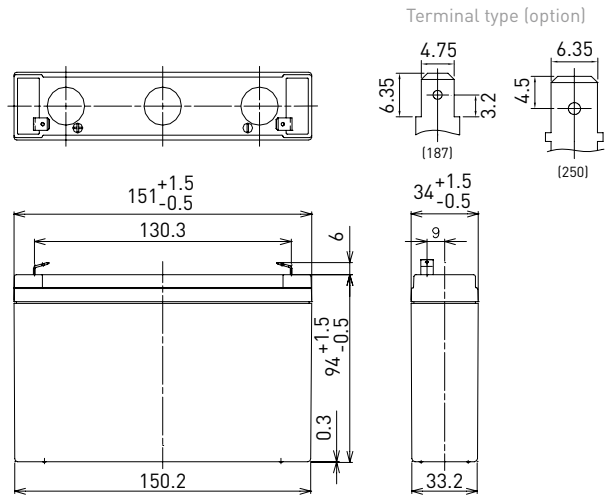

Contents indicated (including the recycle marking, etc.) are subject to change without notice. Battery case resin: flame-retardant (UL94 V-0)

Specifications		LC-P067R2P/P1
Nominal voltage (V)		6
Nominal capacity	20 hours rate (Ah)	7.2
Dimensions	Length (mm)	34
	Width (mm)	151
	Total height (mm)	100
Approx. mass (kg)		1.30
Terminal type		Faston 187/250
Capacity (25°C)	20 hours rate (Ah)	7.2
	10 hours rate (Ah)	6.6
	3 hours rate (Ah)	5.8
	1 hour rate (Ah)	4.9
Impedance (mΩ)	Fully charged battery (25°C)	15
	Temperature dependency of capacity (%) – 20 hours rate	
	40°C	102
	25°C	100
	0°C	85
	-15°C	65
Remaining capacity (25°C)	After 3 months (%)	91
	After 6 months (%)	82
	After 12 months (%)	64

DURATION OF DISCHARGE VS. DISCHARGE CURRENT

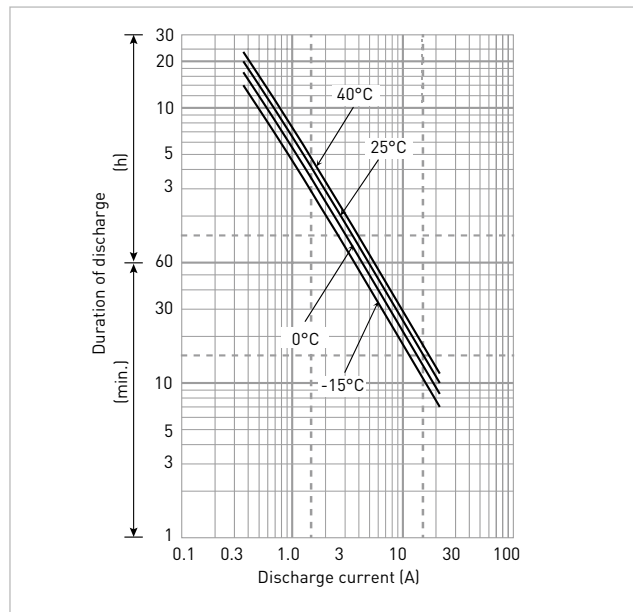

WATT TABLE (25°C)

(Wattage/battery)

Cut-off	3min.	5min.	10min.	15min.	20min.	30min.	45min.	1h	1.5h	2h	3h	4h	5h	6h	10h	20h
4.80V	215	167	110	83.5	67.1	49.2	36.0	28.2	22.3	17.3	12.3	9.60	7.69	6.40	4.19	2.30
4.95V	202	143	93.5	79.5	64.8	48.2	35.8	27.6	21.9	17.2	12.1	9.53	7.63	6.27	4.18	2.29
5.10V	189	136	91.0	75.5	63.0	47.2	34.3	26.8	20.7	16.3	11.8	9.33	7.32	6.11	4.00	2.21
5.25V	172	124	86.8	72.2	60.2	45.4	33.4	26.2	19.9	15.8	11.5	9.15	7.27	6.05	3.98	2.14
5.40V	154	112	82.0	69.1	57.7	43.6	31.3	24.2	18.6	14.0	10.7	8.46	6.67	5.60	3.71	2.07

AMPERE TABLE (25°C)

(Ampere/battery)

Cut-off	3min.	5min.	10min.	15min.	20min.	30min.	45min.	1h	1.5h	2h	3h	4h	5h	6h	10h	20h
4.80V	38.9	30.6	19.9	14.8	12.3	9.10	6.40	5.10	3.50	2.70	2.00	1.53	1.26	1.02	0.670	0.363
4.95V	36.1	28.7	19.5	14.7	12.1	9.00	6.36	5.05	3.43	2.68	1.99	1.52	1.25	1.01	0.667	0.362
5.10V	34.2	26.9	19.0	14.4	11.9	8.90	6.30	5.00	3.36	2.61	1.97	1.51	1.24	1.00	0.660	0.361
5.25V	31.4	24.1	17.6	13.4	11.3	8.70	6.20	4.90	3.29	2.52	1.94	1.50	1.23	0.988	0.657	0.360
5.40V	29.0	22.3	15.7	12.5	11.0	8.40	6.10	4.80	3.20	2.40	1.90	1.48	1.20	0.972	0.650	0.358

All mentioned values are average values

LC-P067R2P/P1

CHARGING METHOD (25°C)

Cycle use	Control voltage 6.8V - 6.9V Initial current 1.08A or smaller
------------------	---

CUT-OFF VOLTAGE

Discharge current	0.36A - 1.44A	1.44A - 3.6A	3.6A - 7.2A	7.2A - 14.4A	14.4A - 21.6A
Cut-off voltage	5.25V	5.10V	4.95V	4.65V	4.35V

INFLUENCE OF TEMPERATURE ON TRICKLE LIFE

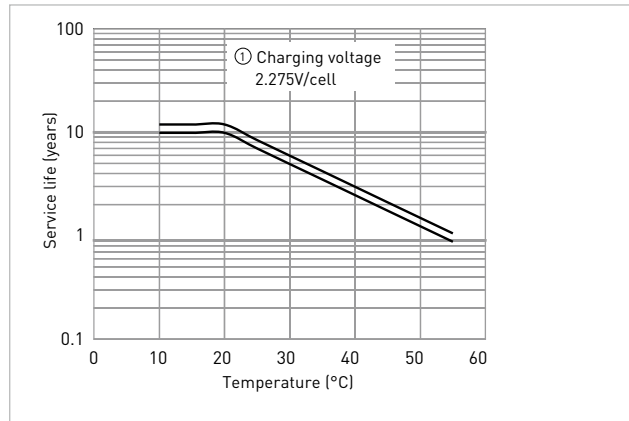

RESIDUAL CAPACITY VS. STORAGE PERIOD

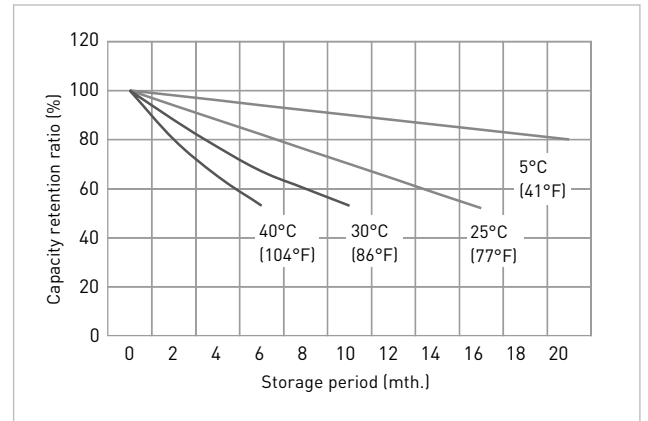

CONSTANT-VOLTAGE CONSTANT-CURRENT CHARGE CHARACTERISTICS FOR TRICKLE USE

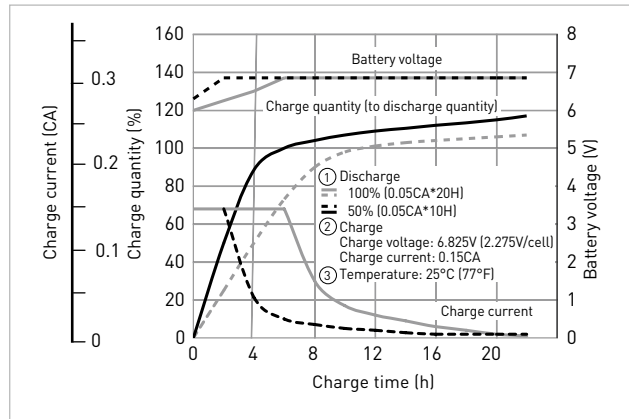

DISCHARGE CAPACITY BY TEMPERATURE AND BY DISCHARGE CURRENT

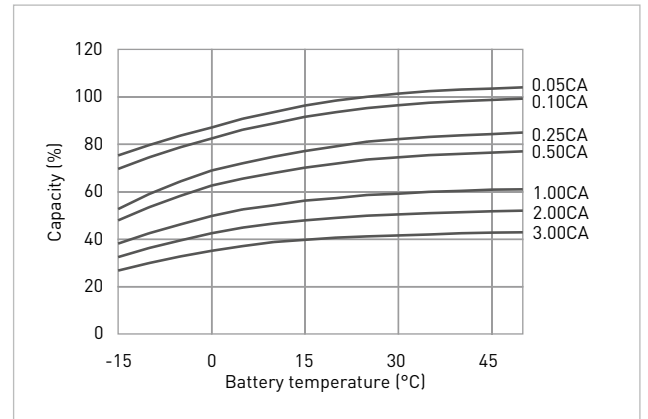

DISCHARGE CHARACTERISTICS

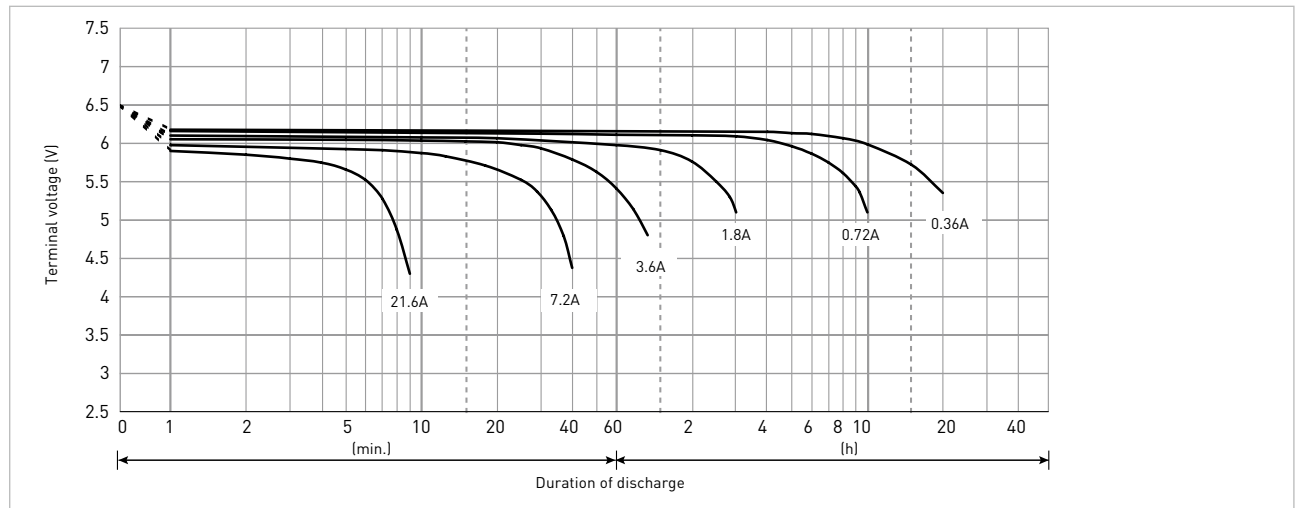

LC-P0612P/P1

FOR STANDBY POWER SUPPLIES.
 EXPECTED TRICKLE DESIGN LIFE: 10 – 12 YEARS AT 20°C
 ACCORDING TO EUROBAT.

DIMENSIONS (MM)



Terminal type (option)

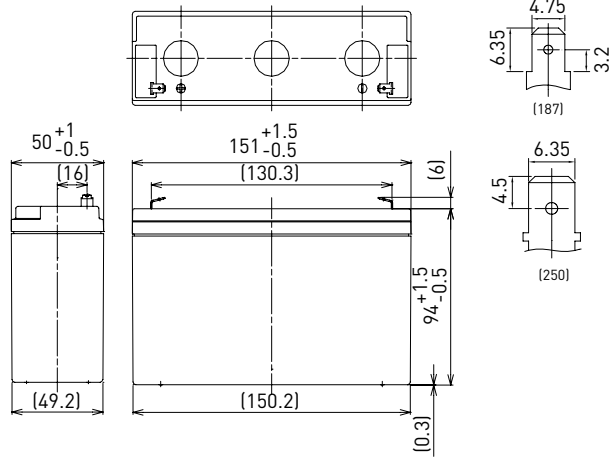

Contents indicated (including the recycle marking, etc.) are subject to change without notice. Battery case resin: flame-retardant (UL94 V-0)

Specifications		LC-P0612P/P1
Nominal voltage [V]		6
Nominal capacity	20 hours rate (Ah)	12.0
Dimensions	Length (mm)	50
	Width (mm)	151
	Total height (mm)	100
Approx. mass (kg)		2.00
Terminal type		Faston 187/250
Capacity (25°C)	20 hours rate (Ah)	12.0
	10 hours rate (Ah)	11.0
	3 hours rate (Ah)	9.3
	1 hour rate (Ah)	8.5
Impedance (mΩ)	Fully charged battery (25°C)	11
Temperature dependency of capacity (%) – 20 hours rate	40°C	102
	25°C	100
	0°C	85
	-15°C	65
Remaining capacity (25°C)	After 3 months (%)	91
	After 6 months (%)	82
	After 12 months (%)	64

DURATION OF DISCHARGE VS. DISCHARGE CURRENT

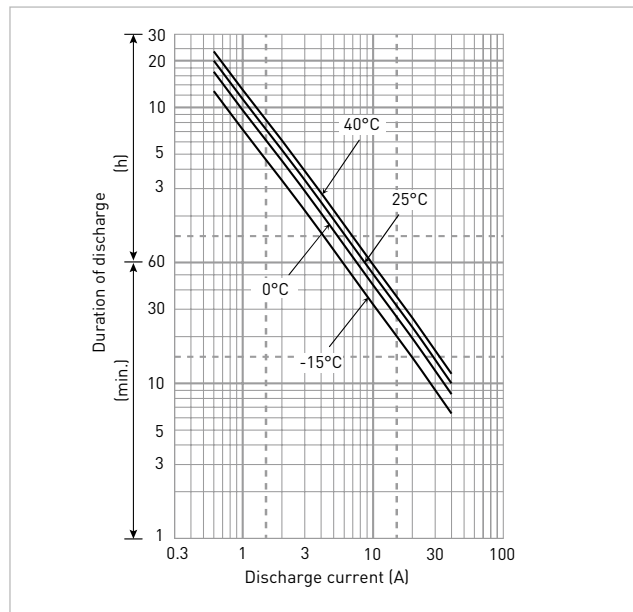

WATT TABLE (25°C)

(Wattage/battery)

Cut-off	3min.	5min.	10min.	15min.	20min.	30min.	45min.	1h	1.5h	2h	3h	4h	5h	6h	10h	20h
4.80V	340	279	192	149	124	91.3	68.7	52.4	35.1	27.2	19.0	14.4	12.0	10.9	6.66	3.61
4.95V	325	269	186	144	121	88.3	67.5	51.8	35.0	27.1	18.9	14.4	12.0	10.9	6.66	3.61
5.10V	304	253	181	141	118	88.3	66.9	51.2	34.5	26.9	18.7	14.4	12.0	10.8	6.60	3.61
5.25V	278	237	171	136	115	86.0	66.3	50.1	34.2	26.6	18.4	14.3	12.0	10.8	6.60	3.60
5.40V	247	217	161	131	113	83.1	61.6	48.9	33.1	26.0	18.1	14.2	11.9	10.7	6.54	3.59

AMPERE TABLE (25°C)

(Ampere/battery)

Cut-off	3min.	5min.	10min.	15min.	20min.	30min.	45min.	1h	1.5h	2h	3h	4h	5h	6h	10h	20h
4.80V	61.1	50.1	34.3	25.9	21.3	15.6	11.7	8.90	5.95	4.60	3.20	2.41	2.01	1.81	1.11	0.602
4.95V	58.4	48.2	33.3	25.0	20.8	15.1	11.5	8.80	5.92	4.58	3.18	2.41	2.01	1.81	1.11	0.602
5.10V	54.6	45.4	32.4	24.5	20.3	15.1	11.4	8.70	5.85	4.55	3.15	2.41	2.00	1.80	1.10	0.601
5.25V	50.0	42.6	30.6	23.6	19.9	14.7	11.3	8.50	5.80	4.50	3.10	2.40	2.00	1.80	1.10	0.600
5.40V	44.5	38.9	28.7	22.7	19.4	14.2	10.5	8.30	5.60	4.40	3.05	2.38	1.99	1.79	1.09	0.598

All mentioned values are average values

LC-P0612P/P1

CHARGING METHOD (25°C)

Cycle use	Control voltage: 6.8V - 6.9V Initial current: 1.8A or smaller
------------------	--

CUT-OFF VOLTAGE

Discharge current	0.6A - 2.4A	2.4A - 6A	6A - 12A	12A - 24A	24A - 36A
Cut-off voltage	5.25V	5.10V	4.95V	4.65V	4.35V

INFLUENCE OF TEMPERATURE ON TRICKLE LIFE

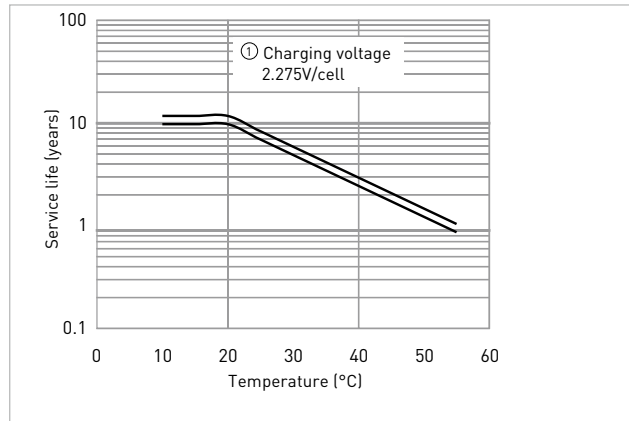

RESIDUAL CAPACITY VS. STORAGE PERIOD

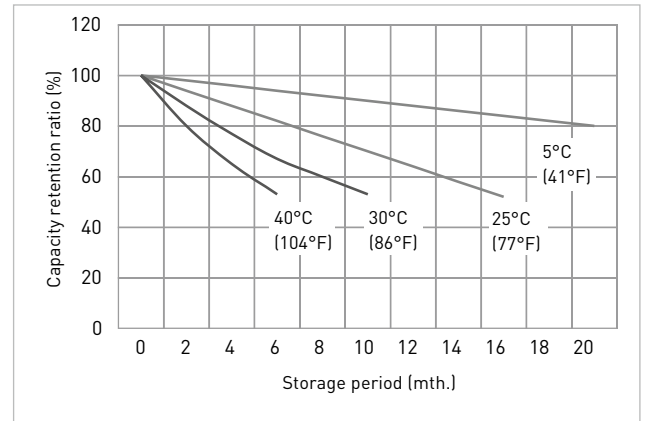

CONSTANT-VOLTAGE CONSTANT-CURRENT CHARGE CHARACTERISTICS FOR TRICKLE USE

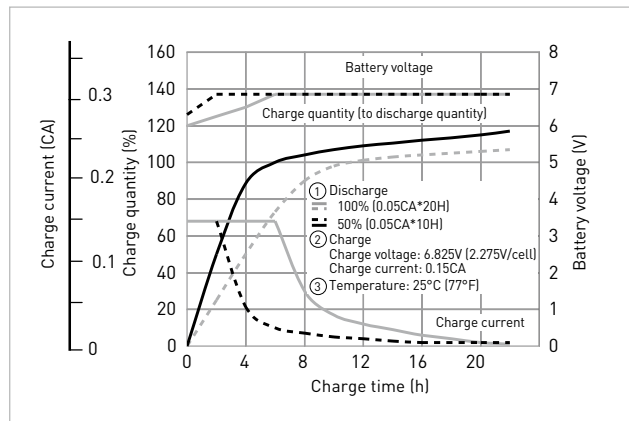

DISCHARGE CAPACITY BY TEMPERATURE AND BY DISCHARGE CURRENT

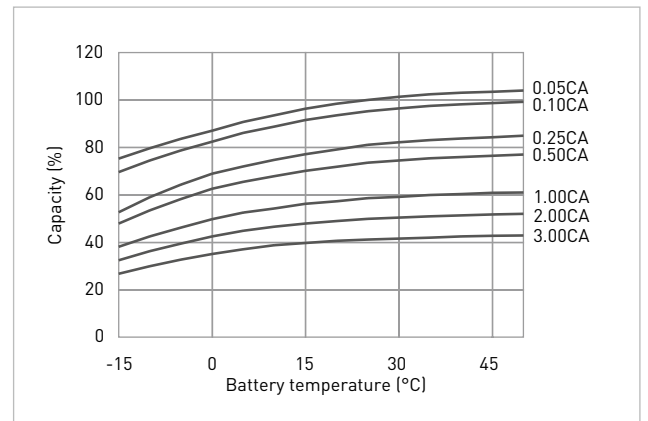

DISCHARGE CHARACTERISTICS

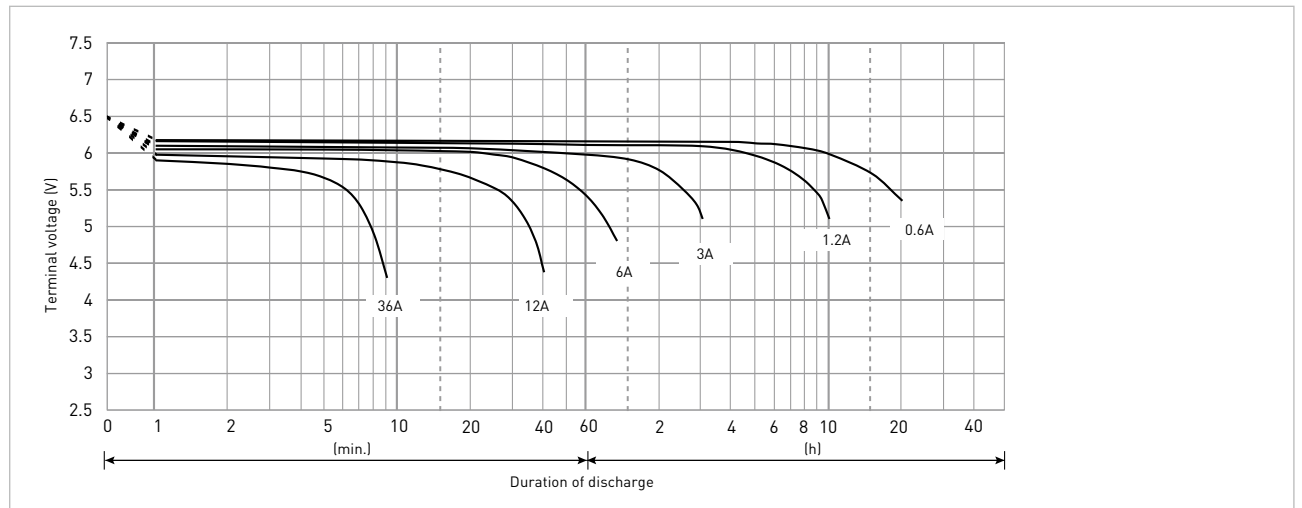

LC-P06200TA

FOR STANDBY POWER SUPPLIES.
 EXPECTED TRICKLE DESIGN LIFE: 10 – 12 YEARS AT 20°C
 ACCORDING TO EUROBAT.

DIMENSIONS (MM)



Contents indicated (including the recycle marking, etc.) are subject to change without notice. Battery case resin: flame-retardant (UL94 V-0)

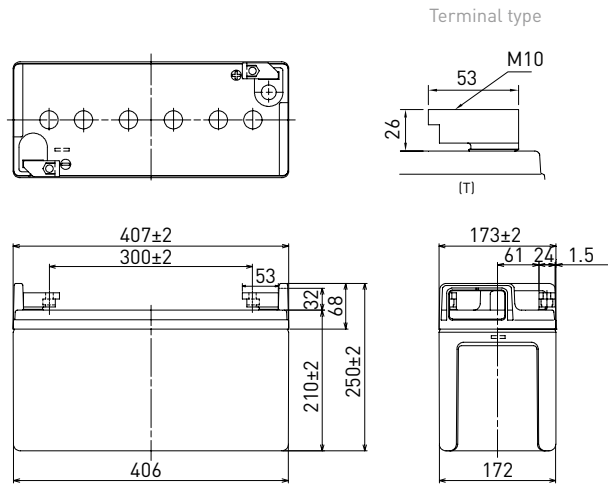

Specifications		LC-P06200TA
Nominal voltage (V)		6
Nominal capacity	20 hours rate (Ah)	200
Dimensions	Length (mm)	173
	Width (mm)	407
	Total height (mm)	250
Approx. mass (kg)		33.5
Terminal type		M10 T-shape
Capacity (25°C)	20 hours rate (Ah)	200
	10 hours rate (Ah)	195
	3 hours rate (Ah)	166
	1 hour rate (Ah)	120
Impedance (mΩ)	Fully charged battery (25°C)	2
	Temperature dependency of capacity (%) – 20 hours rate	
	40°C	102
	25°C	100
	0°C	85
	-15°C	65
Remaining capacity (25°C)	After 3 months (%)	91
	After 6 months (%)	82
	After 12 months (%)	64

DURATION OF DISCHARGE VS. DISCHARGE CURRENT

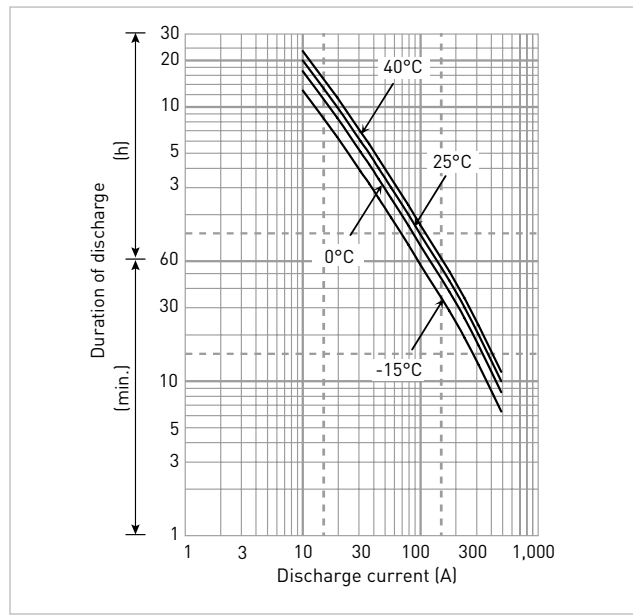

WATT TABLE (25°C)

(Wattage/battery)

Cut-off	5min.	10min.	15min.	20min.	30min.	45min.	1h	1.5h	2h	3h	4h	5h	6h	10h	20h
4.80V	2,786	2,306	1,892	1,592	1,206	892	721	525	434	296	225	183	154	93.2	47.0
4.95V	2,737	2,254	1,847	1,554	1,177	885	702	511	423	291	220	178	149	90.0	46.7
5.10V	2,565	2,204	1,781	1,498	1,139	877	683	497	417	286	215	173	145	88.9	46.1
5.25V	2,298	2,134	1,759	1,487	1,130	852	664	483	408	281	213	170	143	87.9	45.8
5.40V	2,031	1,947	1,676	1,479	1,094	840	655	476	399	275	208	167	140	86.8	45.5

AMPERE TABLE (25°C)

(Ampere/battery)

Cut-off	5min.	10min.	15min.	20min.	30min.	45min.	1h	1.5h	2h	3h	4h	5h	6h	10h	20h
4.80V	591	485	384	318	241	179	135	99.0	81.8	57.9	44.9	37.8	31.2	19.8	10.3
4.95V	530	480	382	316	239	174	130	97.1	81.2	56.8	44.5	37.2	31.1	19.7	10.2
5.10V	468	467	380	312	235	173	125	96.3	80.2	56.4	44.1	36.6	31.0	19.6	10.1
5.25V	408	433	359	298	231	172	120	95.2	79.2	55.2	43.6	36.4	30.5	19.5	10.0
5.40V	357	379	348	290	228	148	115	85.7	75.2	53.9	43.0	36.2	30.0	19.4	9.80

All mentioned values are average values

LC-P06200TA

CHARGING METHOD (25°C)

Cycle use	Control voltage: 6.8V - 6.9V Initial current: 30.0A or smaller
------------------	---

CUT-OFF VOLTAGE

Discharge current	10.0A - 40.0A	40.0A - 100A	100A - 200A	200A - 400A	400A - 600A
Cut-off voltage	5.25V	5.10V	4.95V	4.65V	4.35V

INFLUENCE OF TEMPERATURE ON TRICKLE LIFE

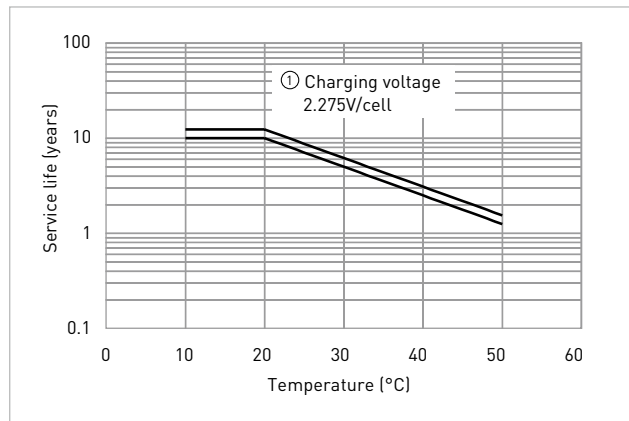

RESIDUAL CAPACITY TEST RESULT

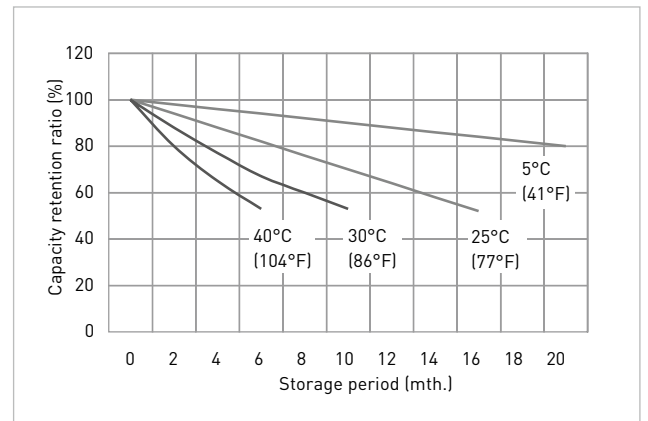

CONSTANT-VOLTAGE CONSTANT-CURRENT CHARGE CHARACTERISTICS FOR TRICKLE USE

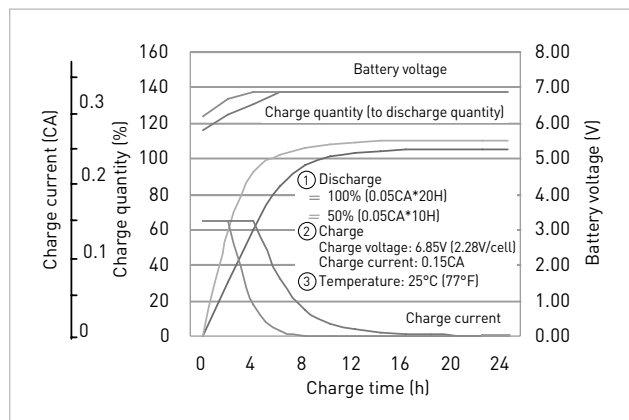

DISCHARGE CAPACITY BY TEMPERATURE AND BY DISCHARGE CURRENT

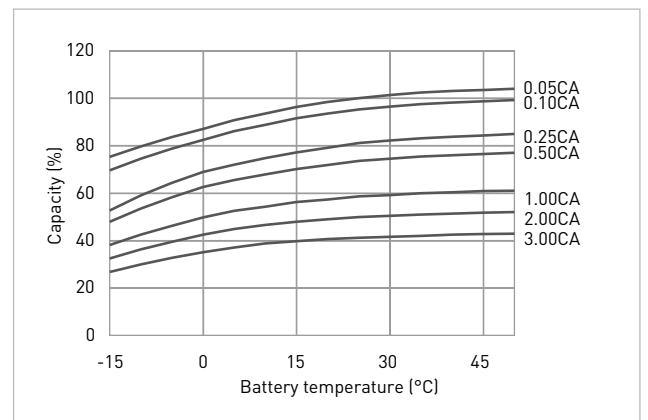

DISCHARGE CHARACTERISTICS

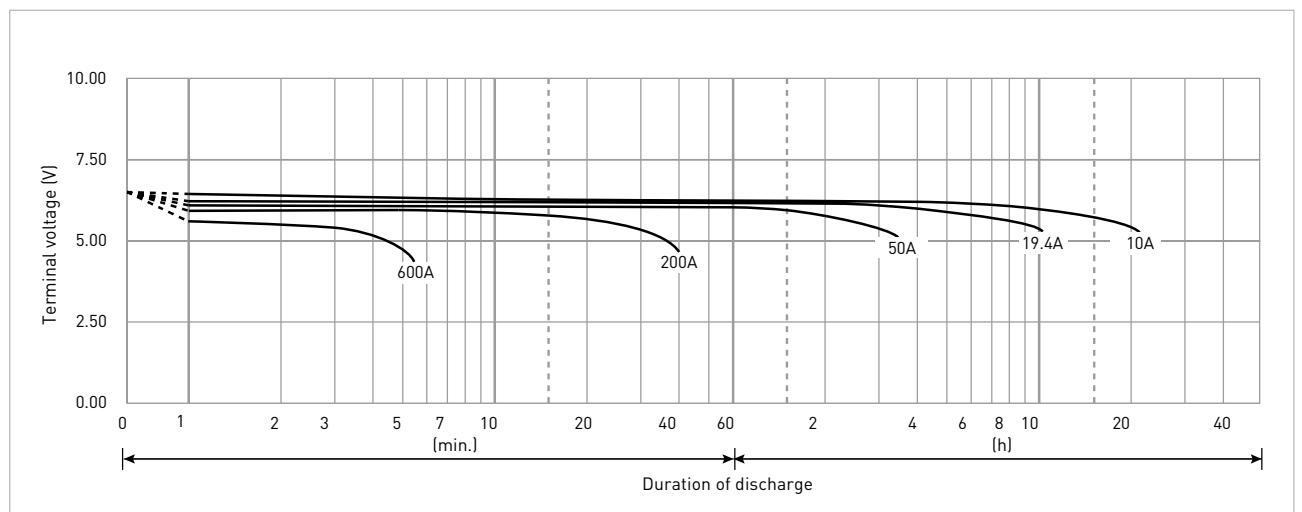

LC-P122R2P

FOR STANDBY POWER SUPPLIES.
 EXPECTED TRICKLE DESIGN LIFE: 10 – 12 YEARS AT 20°C
 ACCORDING TO EUROBAT.

DIMENSIONS (MM)



Contents indicated (including the recycle marking, etc.) are subject to change without notice. Battery case resin: flame-retardant (UL94 V-0)

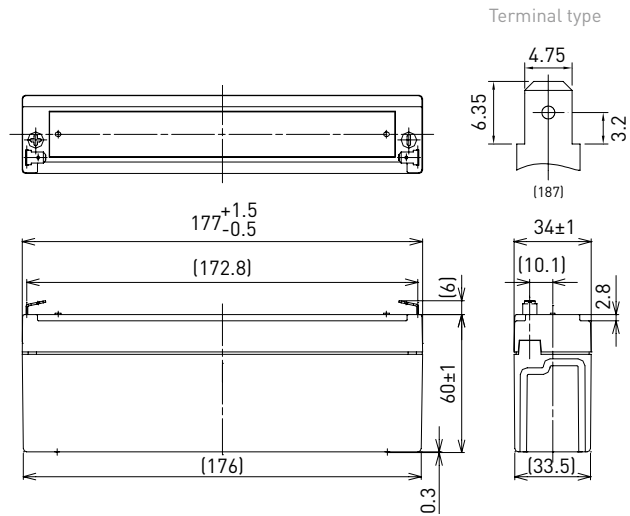

Specifications		LC-P122R2P
Nominal voltage [V]		12
Nominal capacity	20 hours rate [Ah]	2.2
Dimensions	Length [mm]	34
	Width [mm]	177
	Total height [mm]	66
Approx. mass [kg]		0.80
Terminal type		Faston 187
Capacity [25°C]	20 hours rate [Ah]	2.2
	10 hours rate [Ah]	2.0
	3 hours rate [Ah]	1.8
	1 hour rate [Ah]	1.5
Impedance [mΩ]	Fully charged battery [25°C]	70
	40°C	102
Temperature dependency of capacity [%] – 20 hours rate	25°C	100
	0°C	85
	-15°C	65
	After 3 months [%]	91
Remaining capacity [25°C]	After 6 months [%]	82
	After 12 months [%]	64

DURATION OF DISCHARGE VS. DISCHARGE CURRENT

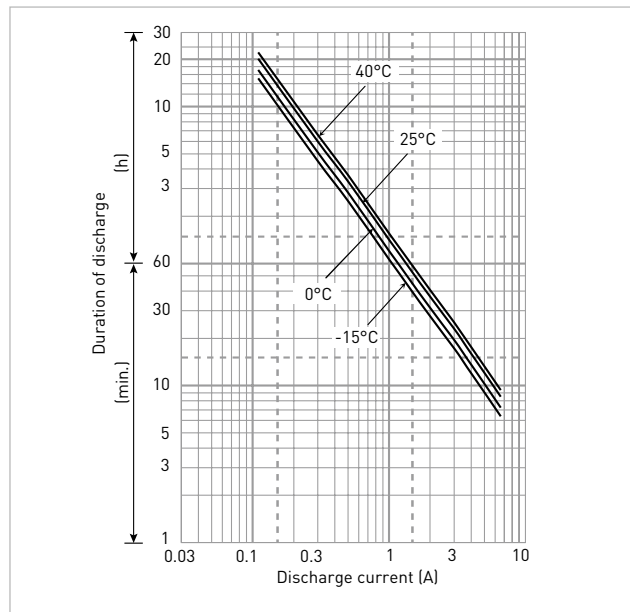

WATT TABLE (25°C)

(Wattage/battery)

Cut-off	3min.	5min.	10min.	15min.	20min.	30min.	45min.	1h	1.5h	2h	3h	4h	5h	6h	10h	20h
9.6V	132	104	68.1	52.0	43.6	32.5	23.0	18.4	12.6	9.77	7.27	5.59	4.61	3.71	2.46	1.33
9.9V	123	97.8	66.7	51.7	42.9	32.2	22.8	18.4	12.4	9.70	7.24	5.55	4.58	3.69	2.45	1.33
10.2V	113	91.6	65.0	50.6	42.2	31.8	22.6	18.0	12.1	9.44	7.16	5.51	4.54	3.66	2.42	1.32
10.5V	101	82.1	60.2	47.1	40.1	31.1	22.2	17.6	11.9	9.12	7.05	5.48	4.50	3.62	2.41	1.32
10.8V	85	72.6	53.7	43.9	39.0	30.0	21.9	17.3	11.5	8.68	6.91	5.40	4.39	3.56	2.38	1.31

AMPERE TABLE (25°C)

(Ampere/battery)

Cut-off	3min.	5min.	10min.	15min.	20min.	30min.	45min.	1h	1.5h	2h	3h	4h	5h	6h	10h	20h
9.6V	11.9	9.35	6.08	4.52	3.76	2.78	1.96	1.56	1.07	0.825	0.611	0.468	0.385	0.309	0.205	0.111
9.9V	11.0	8.77	5.96	4.49	3.70	2.75	1.94	1.56	1.05	0.819	0.608	0.464	0.382	0.308	0.204	0.111
10.2V	10.2	8.22	5.81	4.40	3.64	2.72	1.93	1.53	1.03	0.798	0.602	0.461	0.379	0.306	0.202	0.110
10.5V	9.0	7.36	5.38	4.09	3.45	2.66	1.89	1.50	1.01	0.770	0.593	0.458	0.376	0.302	0.201	0.110
10.8V	7.6	6.51	4.80	3.82	3.36	2.57	1.86	1.47	0.98	0.733	0.581	0.452	0.367	0.297	0.199	0.109

All mentioned values are average values

LC-P122R2P

CHARGING METHOD (25°C)

Cycle use	Control voltage: 13.6V - 13.8V Initial current: 0.33A or smaller
------------------	---

CUT-OFF VOLTAGE

Discharge current	0.011A - 0.44A	0.44A - 1.1A	1.1A - 2.2A	2.2A - 4.4A	4.4A - 6.6A
Cut-off voltage	10.5V	10.2V	9.9V	9.3V	8.7V

INFLUENCE OF TEMPERATURE ON TRICKLE LIFE

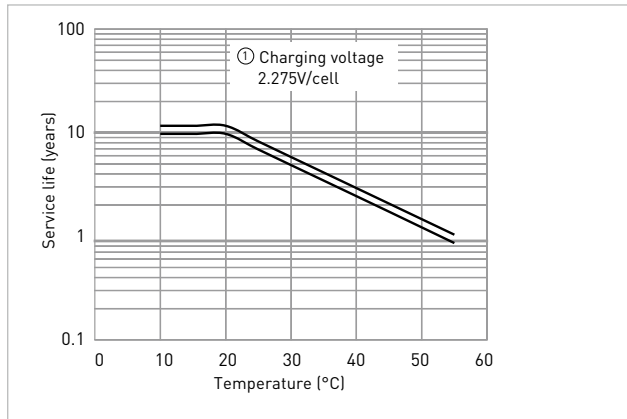

RESIDUAL CAPACITY VS. STORAGE PERIOD

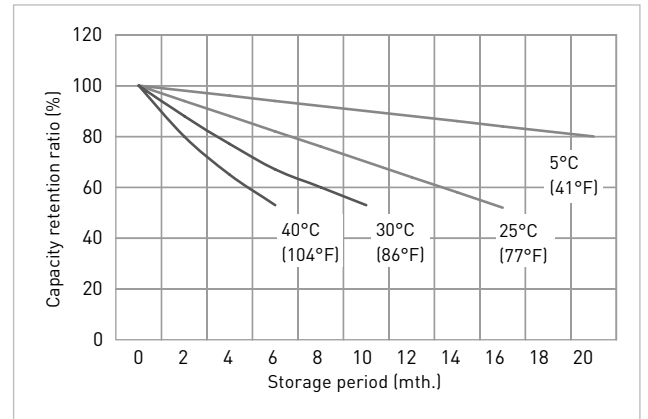

CONSTANT-VOLTAGE CONSTANT-CURRENT CHARGE CHARACTERISTICS FOR TRICKLE USE

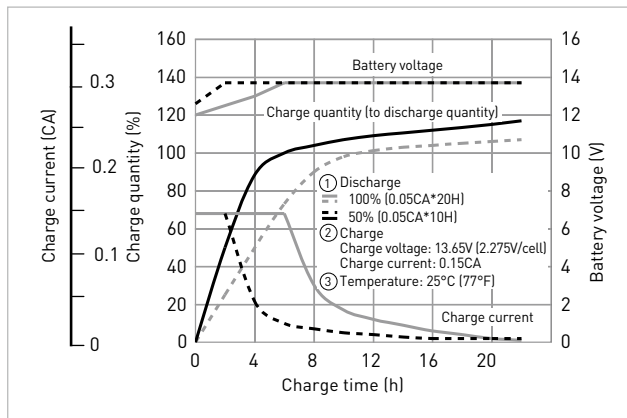

DISCHARGE CAPACITY BY TEMPERATURE AND BY DISCHARGE CURRENT

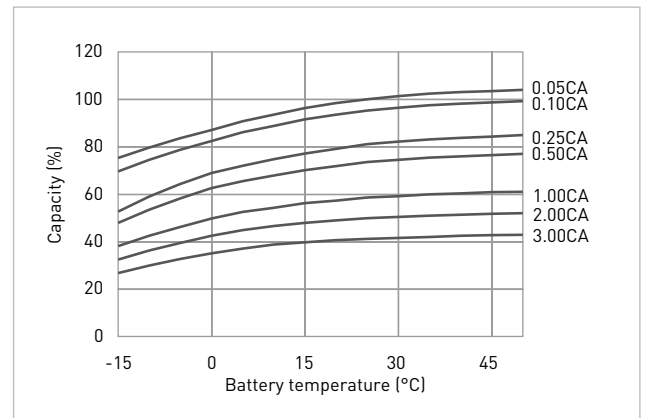

DISCHARGE CHARACTERISTICS

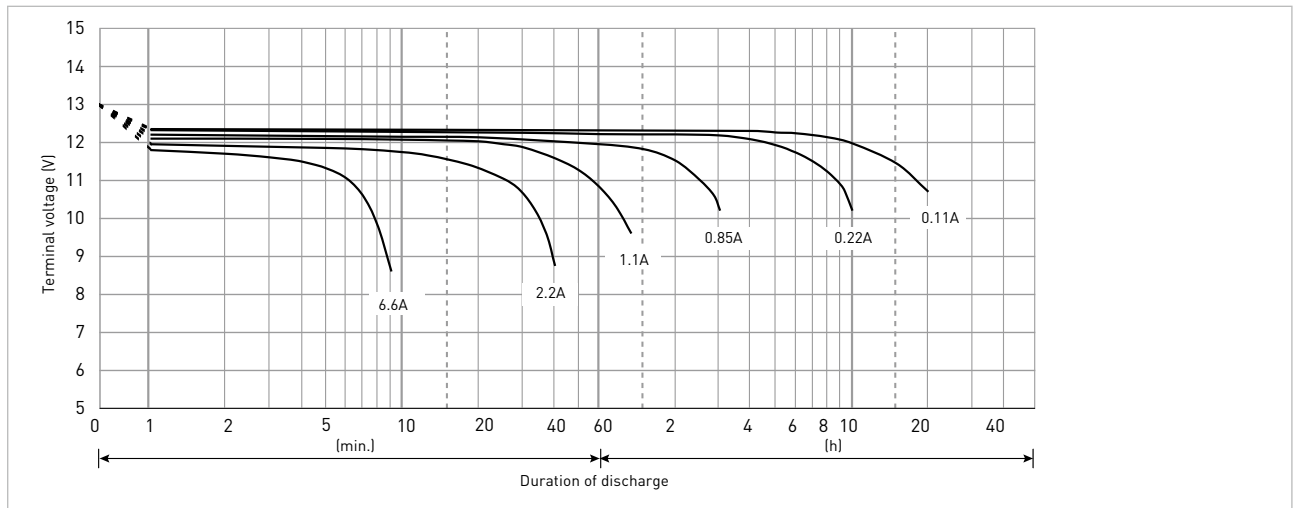

LC-P123R4P

FOR STANDBY POWER SUPPLIES.
 EXPECTED TRICKLE DESIGN LIFE: 10 – 12 YEARS AT 20°C
 ACCORDING TO EUROBAT.

DIMENSIONS (MM)



Contents indicated (including the recycle marking, etc.) are subject to change without notice. Battery case resin: flame-retardant (UL94 V-0)

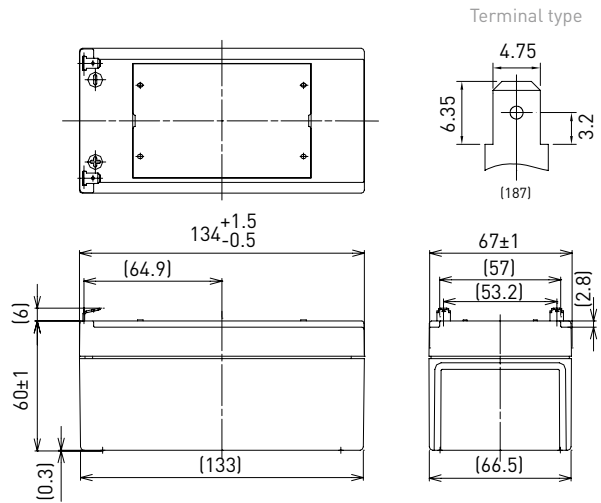

Specifications		LC-P123R4P
Nominal voltage (V)		12
Nominal capacity	20 hours rate (Ah)	3.4
Dimensions	Length (mm)	67
	Width (mm)	134
	Total height (mm)	66
Approx. mass (kg)		1.15
Terminal type		Faston 187
Capacity (25°C)	20 hours rate (Ah)	3.4
	10 hours rate (Ah)	3.1
	3 hours rate (Ah)	2.8
	1 hour rate (Ah)	2.3
Impedance (mΩ)	Fully charged battery (25°C)	50
	40°C	102
Temperature dependency of capacity (%) – 20 hours rate	25°C	100
	0°C	85
	-15°C	65
	-30°C	45
Remaining capacity (25°C)	After 3 months (%)	91
	After 6 months (%)	82
	After 12 months (%)	64

DURATION OF DISCHARGE VS. DISCHARGE CURRENT

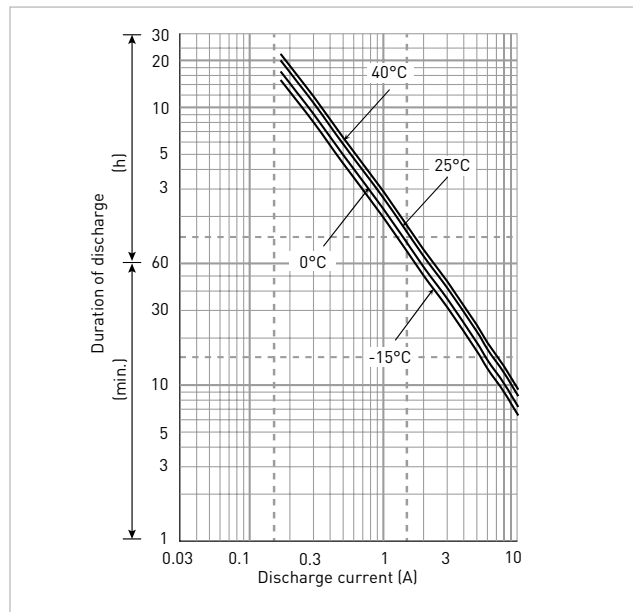

WATT TABLE (25°C)

(Wattage/battery)

Cut-off	3min.	5min.	10min.	15min.	20min.	30min.	45min.	1h	1.5h	2h	3h	4h	5h	6h	10h	20h
9.6V	204	161	105	80.4	67.4	50.3	35.5	28.4	19.6	15.0	11.3	8.63	7.13	5.80	3.81	2.06
9.9V	190	151	103	79.8	66.3	49.7	35.3	28.4	19.2	14.9	11.2	8.58	7.07	5.78	3.80	2.05
10.2V	175	142	100	78.2	65.2	49.2	34.9	27.8	18.8	14.5	11.1	8.52	7.01	5.73	3.76	2.05
10.5V	155	127	93	72.8	61.9	48.1	34.4	27.3	18.4	14.0	11.0	8.46	6.96	5.66	3.74	2.04
10.8V	131	112	83	67.9	60.3	46.4	33.8	26.7	17.8	13.4	10.7	8.46	6.79	5.66	3.68	1.98

AMPERE TABLE (25°C)

(Ampere/battery)

Cut-off	3min.	5min.	10min.	15min.	20min.	30min.	45min.	1h	1.5h	2h	3h	4h	5h	6h	10h	20h
9.6V	18.4	14.4	9.40	6.99	5.81	4.30	3.02	2.41	1.66	1.26	0.949	0.722	0.595	0.484	0.318	0.171
9.9V	17.0	13.6	9.21	6.94	5.71	4.25	3.00	2.41	1.62	1.26	0.945	0.718	0.590	0.482	0.316	0.171
10.2V	15.7	12.7	8.97	6.80	5.62	4.20	2.97	2.36	1.59	1.22	0.935	0.713	0.586	0.478	0.313	0.170
10.5V	14.0	11.4	8.31	6.33	5.34	4.11	2.93	2.31	1.56	1.18	0.921	0.708	0.581	0.472	0.312	0.170
10.8V	11.8	10.1	7.41	5.90	5.19	3.97	2.88	2.27	1.51	1.13	0.897	0.708	0.567	0.472	0.307	0.165

All mentioned values are average values

LC-P123R4P

CHARGING METHOD (25°C)

Cycle use	Control voltage: 13.6V - 13.8V Initial current: 0.51A or smaller
------------------	---

CUT-OFF VOLTAGE

Discharge current	0.17A - 0.68A	0.68A - 1.7A	1.7A - 3.4A	3.4A - 6.8A	6.8A - 10.2A
Cut-off voltage	10.5V	10.2V	9.9V	9.3V	8.7V

INFLUENCE OF TEMPERATURE ON TRICKLE LIFE

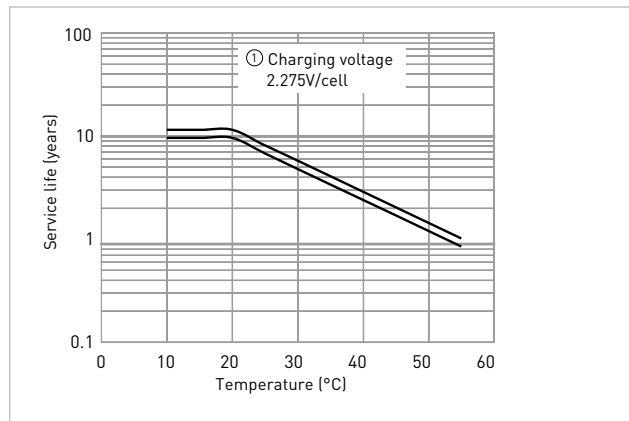

RESIDUAL CAPACITY VS. STORAGE PERIOD

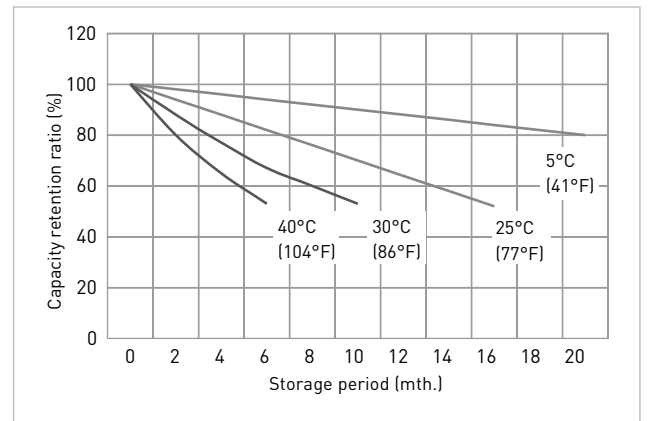

CONSTANT-VOLTAGE CONSTANT-CURRENT CHARGE CHARACTERISTICS FOR TRICKLE USE

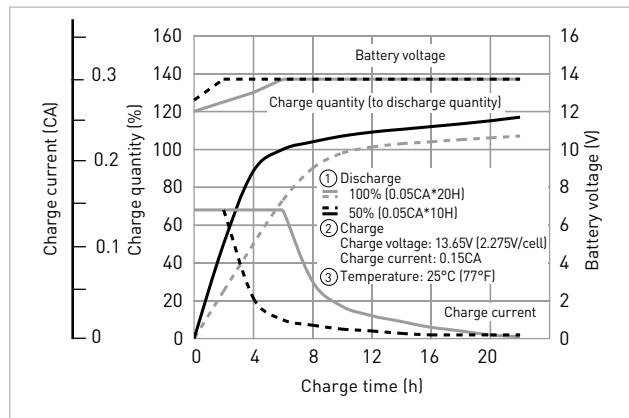

DISCHARGE CAPACITY BY TEMPERATURE AND BY DISCHARGE CURRENT

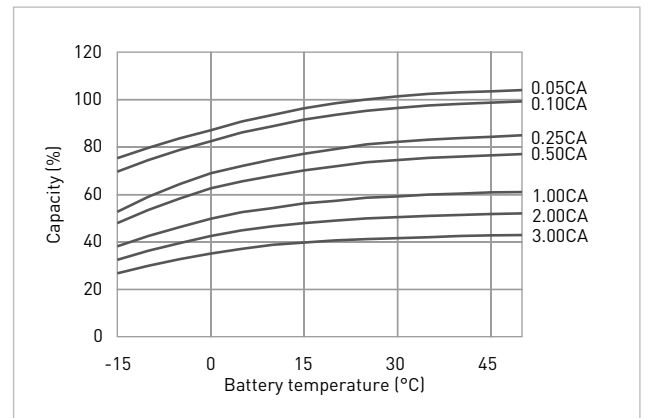

DISCHARGE CHARACTERISTICS

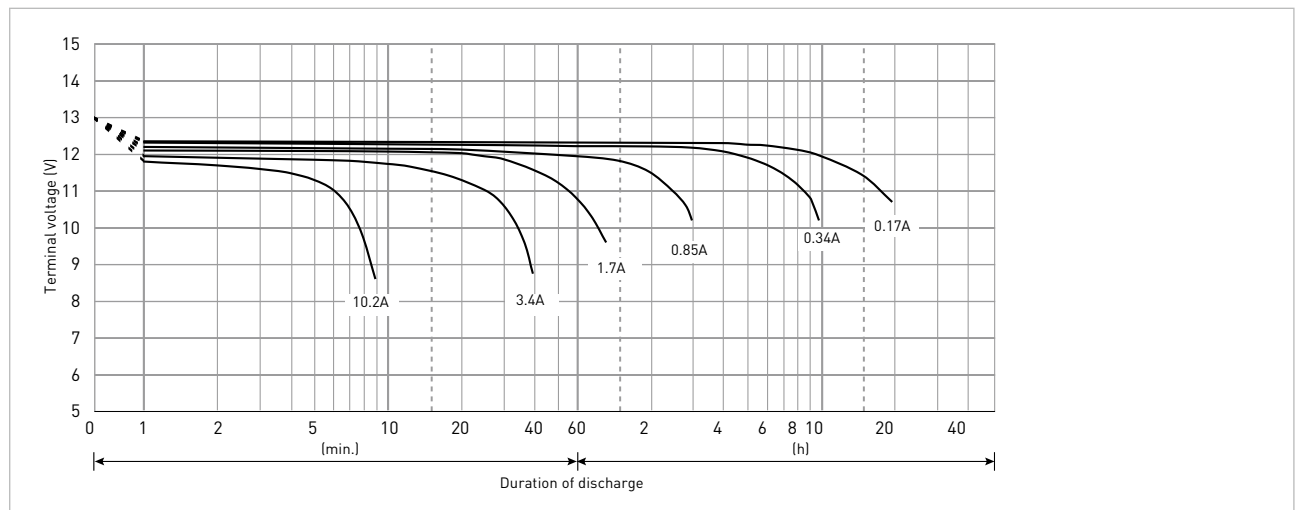

LC-P127R2P/P1

FOR STANDBY POWER SUPPLIES.
 EXPECTED TRICKLE DESIGN LIFE: 10 – 12 YEARS AT 20°C
 ACCORDING TO EUROBAT.

DIMENSIONS (MM)



Contents indicated (including the recycle marking, etc.) are subject to change without notice. Battery case resin: flame-retardant (UL94 V-0)

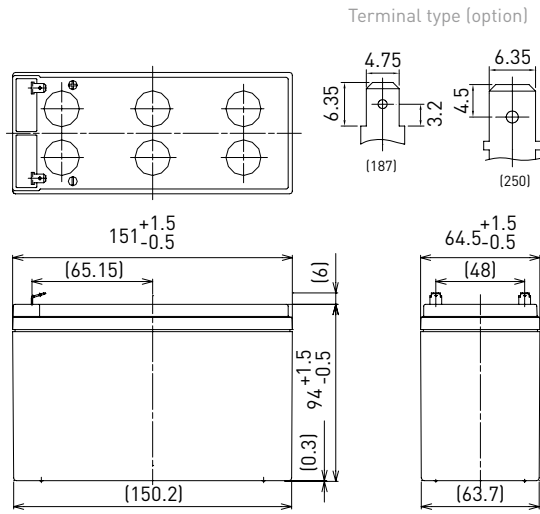

Specifications		LC-P127R2P/P1
Nominal voltage (V)		12
Nominal capacity	20 hours rate (Ah)	7.2
Dimensions	Length (mm)	64.5
	Width (mm)	151
	Total height (mm)	100
Approx. mass (kg)		2.30
Terminal type		Faston 187/250
Capacity (25°C)	20 hours rate (Ah)	7.2
	10 hours rate (Ah)	6.6
	3 hours rate (Ah)	5.8
	1 hour rate (Ah)	4.9
Impedance (mΩ)	Fully charged battery (25°C)	24
	Temperature dependency of capacity (%) – 20 hours rate	
	40°C	102
	25°C	100
	0°C	85
	-15°C	65
Remaining capacity (25°C)	After 3 months (%)	91
	After 6 months (%)	82
	After 12 months (%)	64

DURATION OF DISCHARGE VS. DISCHARGE CURRENT

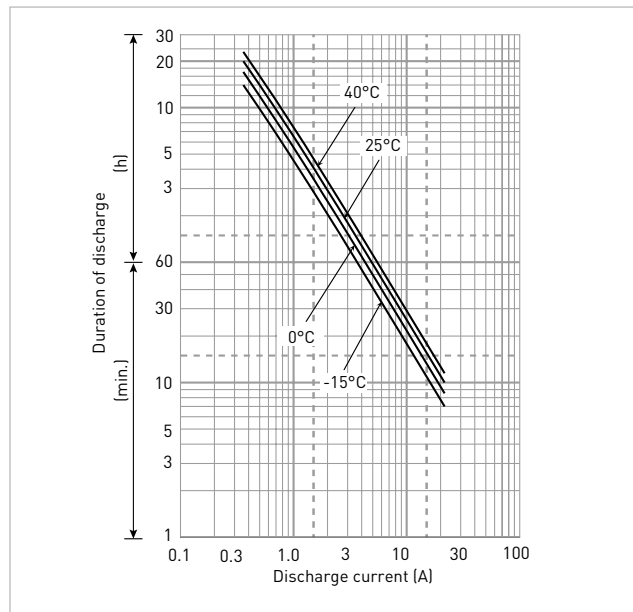

WATT TABLE (25°C)

(Wattage/battery)

Cut-off	3min.	5min.	10min.	15min.	20min.	30min.	45min.	1h	1.5h	2h	3h	4h	5h	6h	10h	20h
9.6V	430	335	220	167	134	98.4	72.1	56.5	44.6	34.7	24.7	19.2	15.4	12.8	8.39	4.60
9.9V	405	287	187	159	130	96.4	71.6	55.1	43.7	34.4	24.5	19.1	15.3	12.5	8.35	4.59
10.2V	379	273	182	151	126	94.3	68.6	53.6	41.4	32.5	23.5	18.7	14.6	12.2	8.00	4.43
10.5V	343	248	174	144	120	90.8	66.8	52.4	39.8	31.5	23.0	18.3	14.5	12.1	7.96	4.42
10.8V	308	223	164	138	115	87.2	62.6	48.4	37.2	28.1	21.4	16.9	13.3	11.2	7.41	4.13

AMPERE TABLE (25°C)

(Ampere/battery)

Cut-off	3min.	5min.	10min.	15min.	20min.	30min.	45min.	1h	1.5h	2h	3h	4h	5h	6h	10h	20h
9.6V	38.9	30.6	19.9	14.8	12.3	9.10	6.40	5.10	3.50	2.70	2.00	1.53	1.26	1.02	0.670	0.363
9.9V	36.1	28.7	19.5	14.7	12.1	9.00	6.36	5.05	3.43	2.68	1.99	1.52	1.25	1.01	0.667	0.362
10.2V	34.2	26.9	19.0	14.4	11.9	8.90	6.30	5.00	3.36	2.61	1.97	1.51	1.24	1.00	0.660	0.361
10.5V	31.4	24.1	17.6	13.4	11.3	8.70	6.20	4.90	3.29	2.52	1.94	1.50	1.23	0.988	0.657	0.360
10.8V	29.0	22.3	15.7	12.5	11.0	8.40	6.10	4.80	3.20	2.40	1.90	1.48	1.20	0.972	0.650	0.358

All mentioned values are average values

LC-P127R2P/P1

CHARGING METHOD (25°C)

Cycle use	Control voltage: 13.6V - 13.8V Initial current: 1.08A or smaller
------------------	---

CUT-OFF VOLTAGE

Discharge current	0.36A - 1.44A	1.44A - 3.6A	3.6A - 7.2A	7.2A - 14.4A	14.4A - 21.6A
Cut-off voltage	10.5V	10.2V	9.9V	9.3V	8.7V

INFLUENCE OF TEMPERATURE ON TRICKLE LIFE

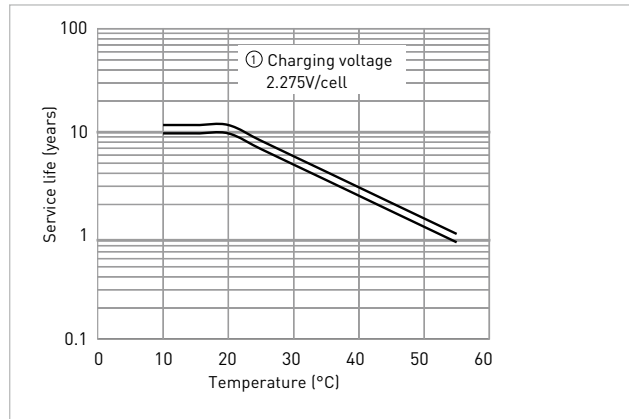

RESIDUAL CAPACITY VS. STORAGE PERIOD

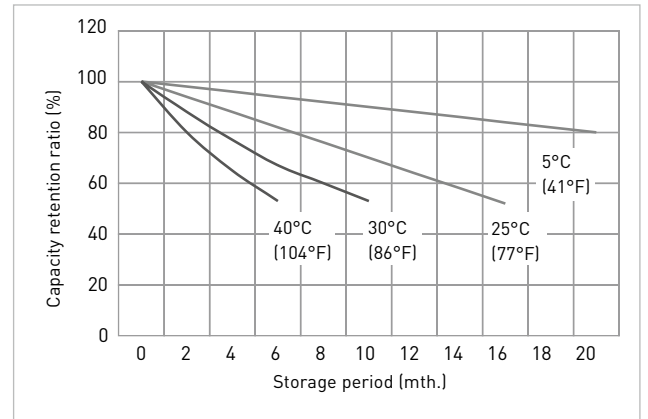

CONSTANT-VOLTAGE CONSTANT-CURRENT CHARGE CHARACTERISTICS FOR TRICKLE USE

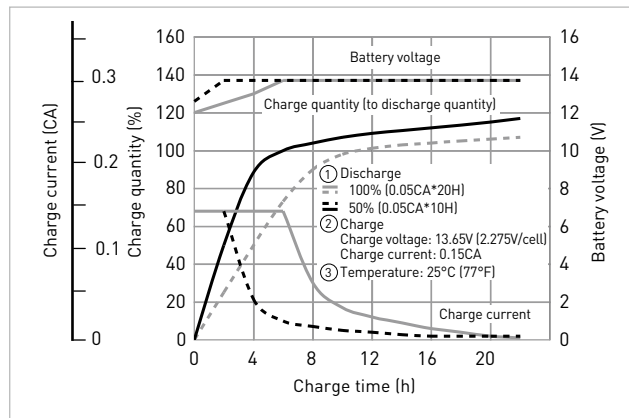

DISCHARGE CAPACITY BY TEMPERATURE AND BY DISCHARGE CURRENT

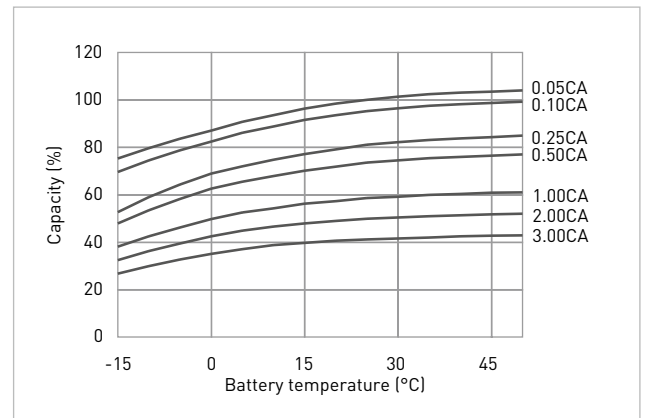

DISCHARGE CHARACTERISTICS

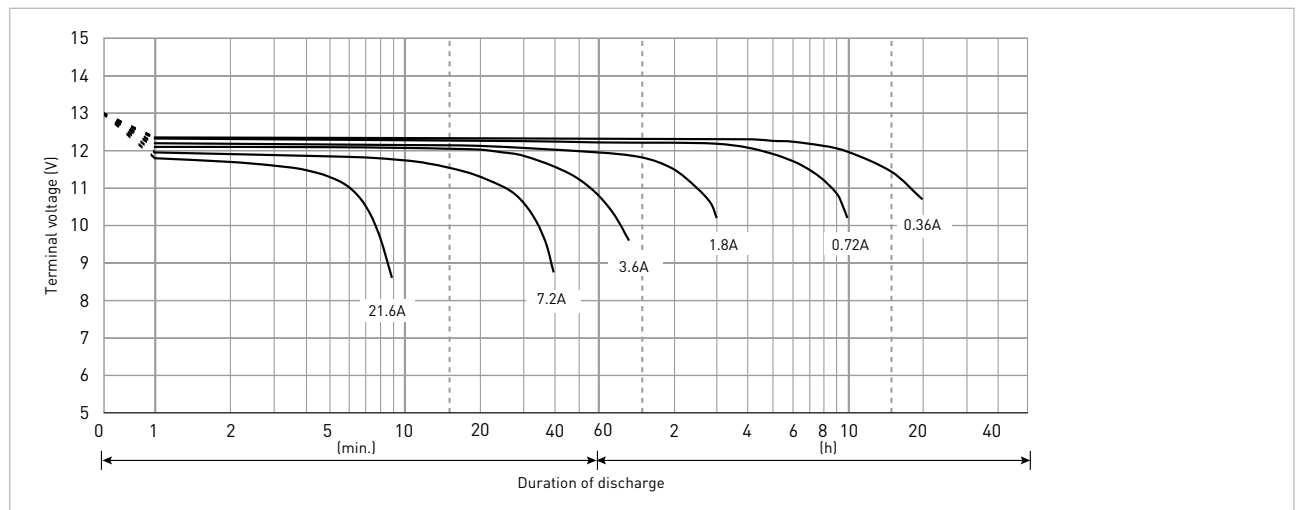

LC-PA1212P/P1

FOR STANDBY POWER SUPPLIES.
 EXPECTED TRICKLE DESIGN LIFE: 10 – 12 YEARS AT 20°C
 ACCORDING TO EUROBAT.

DIMENSIONS (MM)

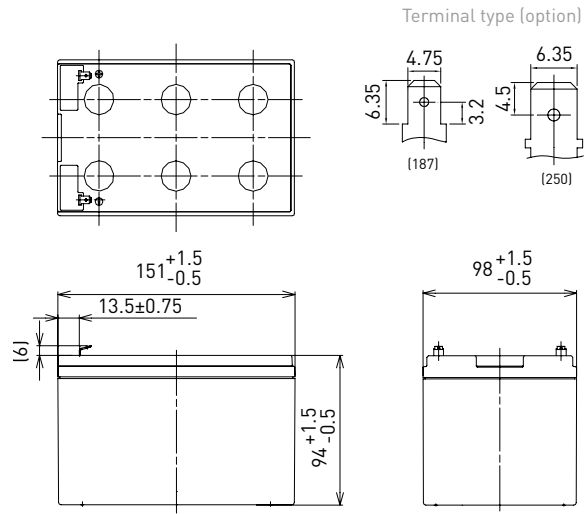

Contents indicated (including the recycle marking, etc.) are subject to change without notice. Battery case resin: flame-retardant (UL94 V-0)

Specifications		LC-PA1212P/P1
Nominal voltage (V)		12
Nominal capacity	20 hours rate (Ah)	12.0
Dimensions	Length (mm)	98
	Width (mm)	151
	Total height (mm)	100
Approx. mass (kg)		3.65
Terminal type		Faston 187/250
Capacity (25°C)	20 hours rate (Ah)	12.0
	10 hours rate (Ah)	11.0
	3 hours rate (Ah)	9.3
	1 hour rate (Ah)	8.5
Impedance (mΩ)	Fully charged battery (25°C)	18
Temperature dependency of capacity (%) – 20 hours rate	40°C	102
	25°C	100
	0°C	85
	-15°C	65
Remaining capacity (25°C)	After 3 months (%)	91
	After 6 months (%)	82
	After 12 months (%)	64

DURATION OF DISCHARGE VS. DISCHARGE CURRENT

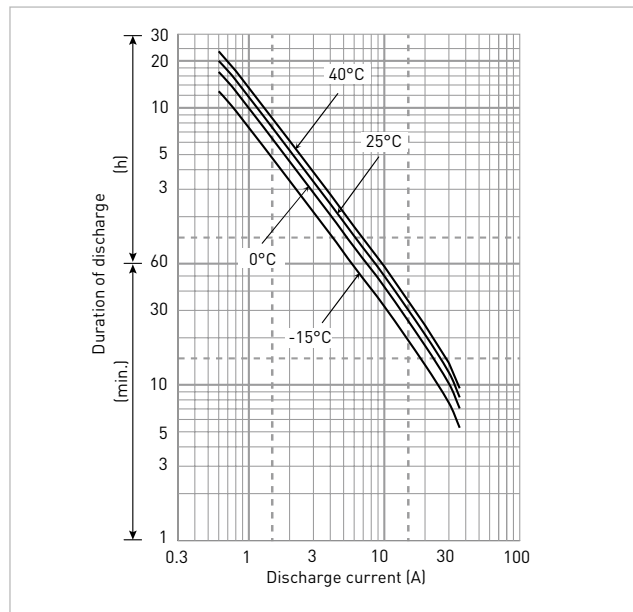

WATT TABLE (25°C)

(Wattage/battery)

Cut-off	3min.	5min.	10min.	15min.	20min.	30min.	45min.	1h	1.5h	2h	3h	4h	5h	6h	10h	20h
9.6V	679	559	384	298	247	183	137	105	70.3	54.5	38.1	28.8	24.1	21.7	13.3	7.22
9.9V	649	537	373	288	241	177	135	104	69.9	54.2	37.8	28.8	24.1	21.7	13.3	7.22
10.2V	607	506	363	282	235	177	134	102	69.1	53.9	37.5	28.8	24.0	21.6	13.2	7.21
10.5V	556	475	343	271	231	172	133	100	68.5	53.3	36.9	28.7	24.0	21.6	13.2	7.20
10.8V	495	434	321	261	225	166	123	98	66.1	52.1	36.3	28.4	23.8	21.5	13.1	7.18

AMPERE TABLE (25°C)

(Ampere/battery)

Cut-off	3min.	5min.	10min.	15min.	20min.	30min.	45min.	1h	1.5h	2h	3h	4h	5h	6h	10h	20h
9.6V	61.1	50.1	34.3	25.9	21.3	15.6	11.7	8.90	5.95	4.60	3.20	2.41	2.01	1.81	1.11	0.602
9.9V	58.4	48.2	33.3	25.0	20.8	15.1	11.5	8.80	5.92	4.58	3.18	2.41	2.01	1.81	1.11	0.602
10.2V	54.6	45.4	32.4	24.5	20.3	15.1	11.4	8.70	5.85	4.55	3.15	2.41	2.00	1.80	1.10	0.601
10.5V	50.0	42.6	30.6	23.6	19.9	14.7	11.3	8.50	5.80	4.50	3.10	2.40	2.00	1.80	1.10	0.600
10.8V	44.5	38.9	28.7	22.7	19.4	14.2	10.5	8.30	5.60	4.40	3.05	2.38	1.99	1.79	1.09	0.598

All mentioned values are average values

LC-PA1212P/P1

CHARGING METHOD (25°C)

Cycle use	Control voltage: 13.6V - 13.8V Initial current: 1.8A or smaller
------------------	--

CUT-OFF VOLTAGE

Discharge current	0.6A - 2.4A	2.4A - 6A	6A - 12A	12A - 24A	24A - 36A
Cut-off voltage	10.5V	10.2V	9.9V	9.3V	8.7V

INFLUENCE OF TEMPERATURE ON TRICKLE LIFE

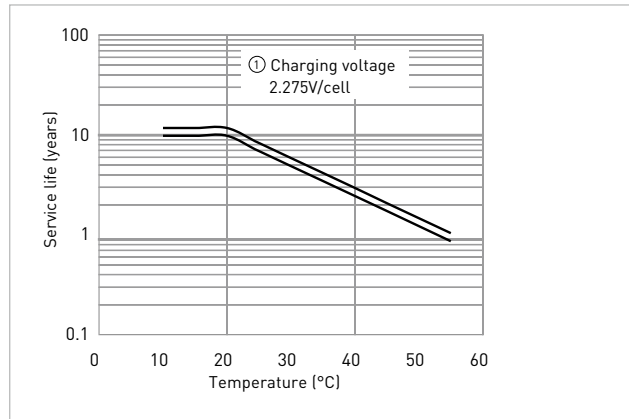

RESIDUAL CAPACITY VS. STORAGE PERIOD

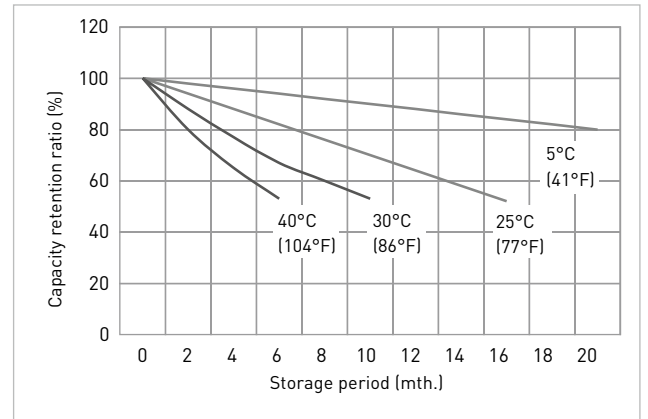

CONSTANT-VOLTAGE CONSTANT-CURRENT CHARGE CHARACTERISTICS FOR TRICKLE USE

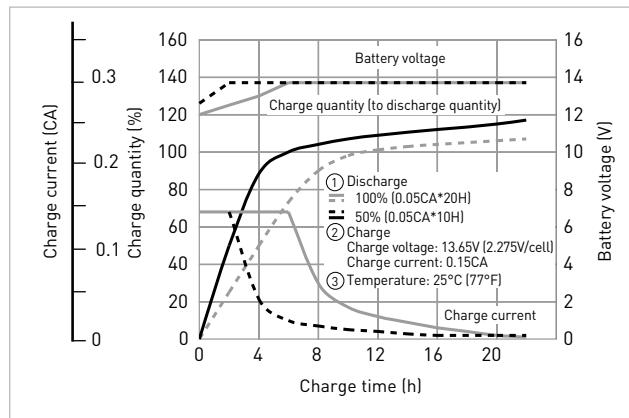

DISCHARGE CAPACITY BY TEMPERATURE AND BY DISCHARGE CURRENT

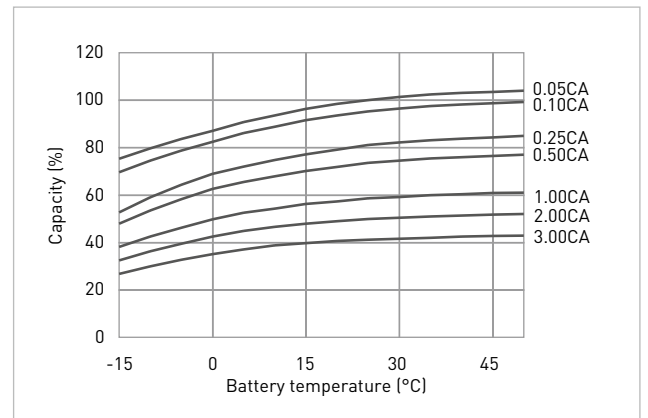

DISCHARGE CHARACTERISTICS

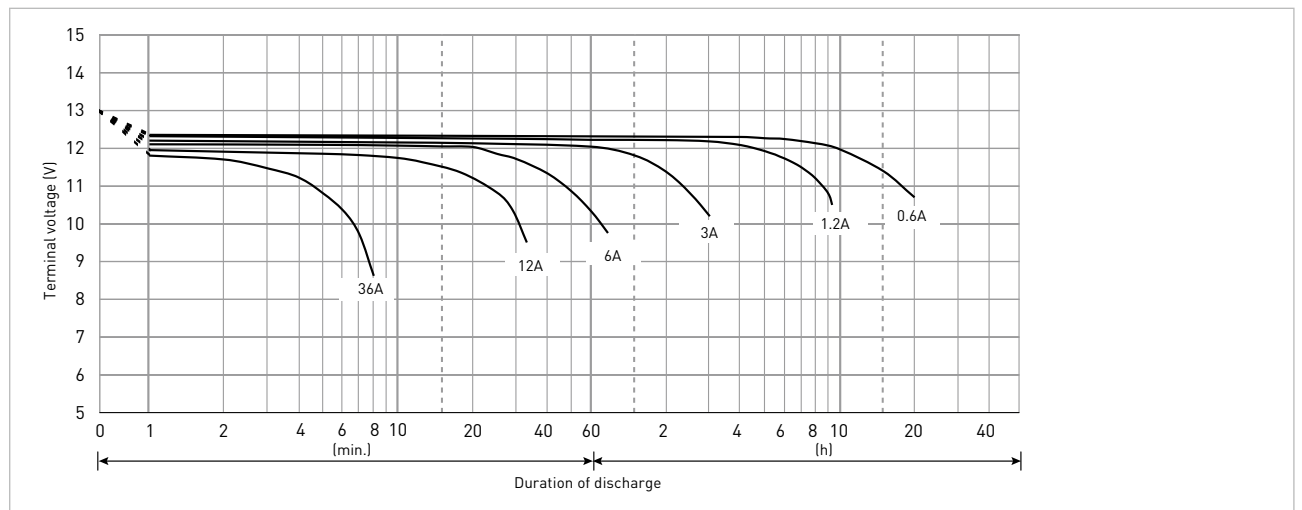

LC-PA1216P/P1

FOR STANDBY POWER SUPPLIES.
 EXPECTED TRICKLE DESIGN LIFE: 10 – 12 YEARS AT 20°C
 ACCORDING TO EUROBAT.

DIMENSIONS (MM)

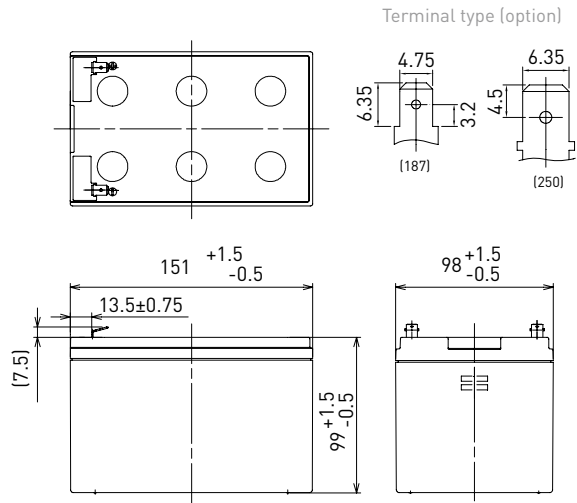

Contents indicated (including the recycle marking, etc.) are subject to change without notice. Battery case resin: flame-retardant (UL94 V-0)

Specifications		LC-PA1216P/P1
Nominal voltage (V)		12
Nominal capacity	20 hours rate (Ah)	16.0
Dimensions	Length (mm)	98
	Width (mm)	151
	Total height (mm)	105
Approx. mass (kg)		4.10
Terminal type		Faston 187/250
Capacity (25°C)	20 hours rate (Ah)	16.0
	10 hours rate (Ah)	15.0
	3 hours rate (Ah)	13.0
	1 hour rate (Ah)	11.0
Impedance (mΩ)	Fully charged battery (25°C)	13
Temperature dependency of capacity (%) – 20 hours rate	40°C	102
	25°C	100
	0°C	85
	-15°C	65
Remaining capacity (25°C)	After 3 months (%)	91
	After 6 months (%)	82
	After 12 months (%)	64

DURATION OF DISCHARGE VS. DISCHARGE CURRENT

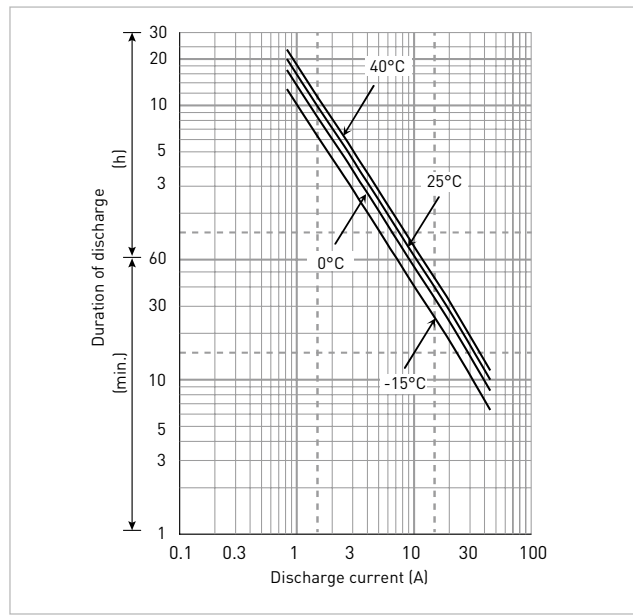

WATT TABLE (25°C)

(Wattage/battery)

Cut-off	3min.	5min.	10min.	15min.	20min.	30min.	45min.	1h	1.5h	2h	3h	4h	5h	6h	10h	20h
9.6V	850	716	445	339	277	201	151	124	91.9	73.1	52.8	41.2	34.5	29.7	19.0	10.2
9.9V	815	685	427	323	268	197	150	121	90.1	72.5	52.6	40.9	34.2	29.1	18.9	10.2
10.2V	760	640	417	307	260	193	144	117	85.4	68.5	50.3	40.1	32.8	28.4	18.1	9.81
10.5V	680	580	398	293	249	185	140	115	82.0	66.4	49.3	39.3	32.7	28.1	18.0	9.78
10.8V	590	520	350	281	238	178	131	106	76.5	59.2	45.7	36.3	29.9	26.0	16.8	9.16

AMPERE TABLE (25°C)

(Ampere/battery)

Cut-off	3min.	5min.	10min.	15min.	20min.	30min.	45min.	1h	1.5h	2h	3h	4h	5h	6h	10h	20h
9.6V	82.9	66.3	44.7	32.7	26.3	19.1	13.8	10.9	7.98	6.21	4.33	3.28	2.82	2.34	1.54	0.800
9.9V	76.5	62.2	43.8	32.5	25.9	18.9	13.7	10.8	7.82	6.17	4.31	3.26	2.79	2.33	1.53	0.800
10.2V	70.3	58.3	42.7	31.8	25.4	18.7	13.6	10.7	7.66	6.01	4.26	3.24	2.77	2.32	1.52	0.800
10.5V	62.3	52.2	39.5	29.6	24.2	18.3	13.4	10.5	7.50	5.80	4.20	3.22	2.75	2.31	1.51	0.800
10.8V	52.4	45.8	35.3	27.6	23.5	17.6	13.2	10.3	7.29	5.52	4.11	3.18	2.68	2.28	1.49	0.800

All mentioned values are average values

LC-PA1216P/P1

CHARGING METHOD (25°C)

Cycle use	Control voltage: 13.6V - 13.8V Initial current: 2.40A or smaller
------------------	---

CUT-OFF VOLTAGE

Discharge current	0.800A - 3.20A	3.20A - 8.00A	8.00A - 16.0A	16.0A - 32.0A	32.0A - 48.0A
Cut-off voltage	10.5V	10.2V	9.9V	9.3V	8.7V

INFLUENCE OF TEMPERATURE ON TRICKLE LIFE

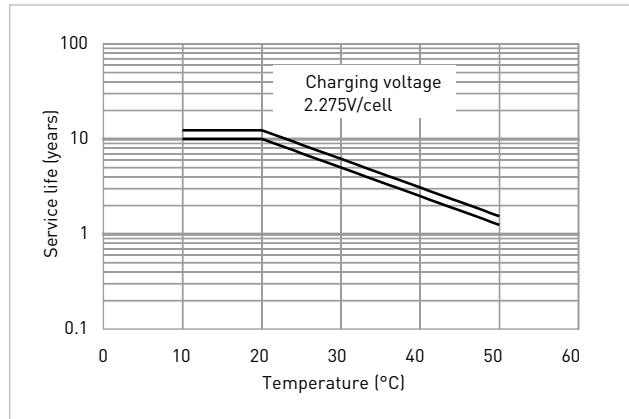

RESIDUAL CAPACITY TEST RESULT

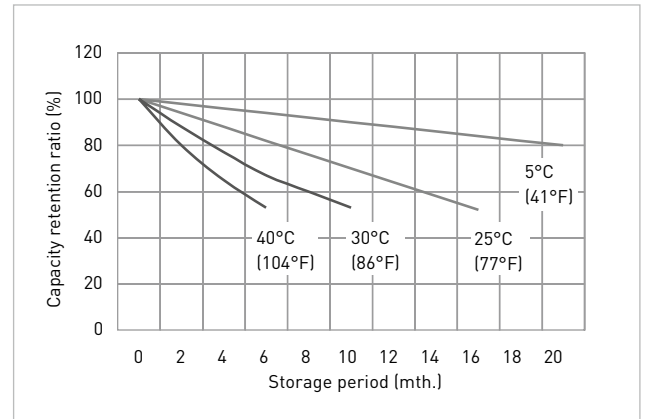

CONSTANT-VOLTAGE CONSTANT-CURRENT CHARGE CHARACTERISTICS FOR TRICKLE USE

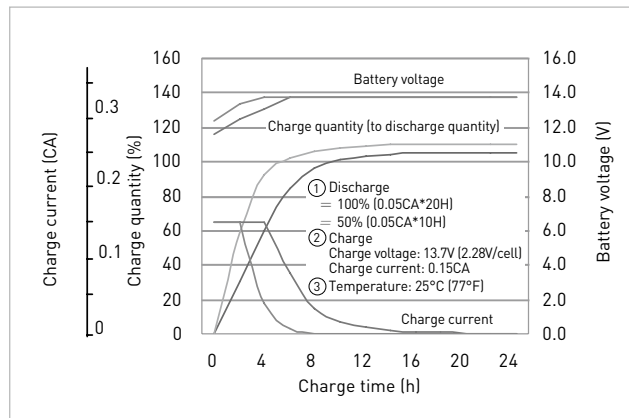

DISCHARGE CAPACITY BY TEMPERATURE AND BY DISCHARGE CURRENT

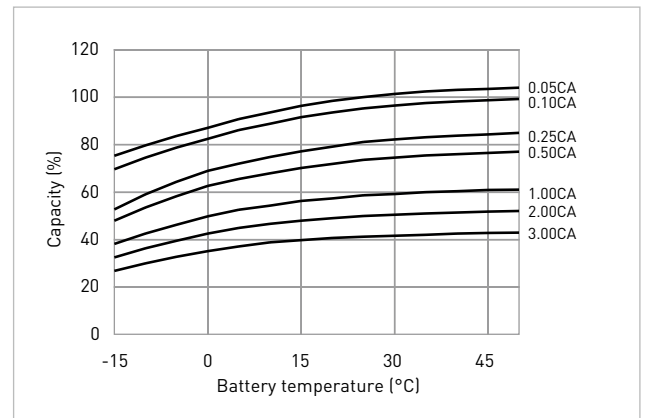

DISCHARGE CHARACTERISTICS

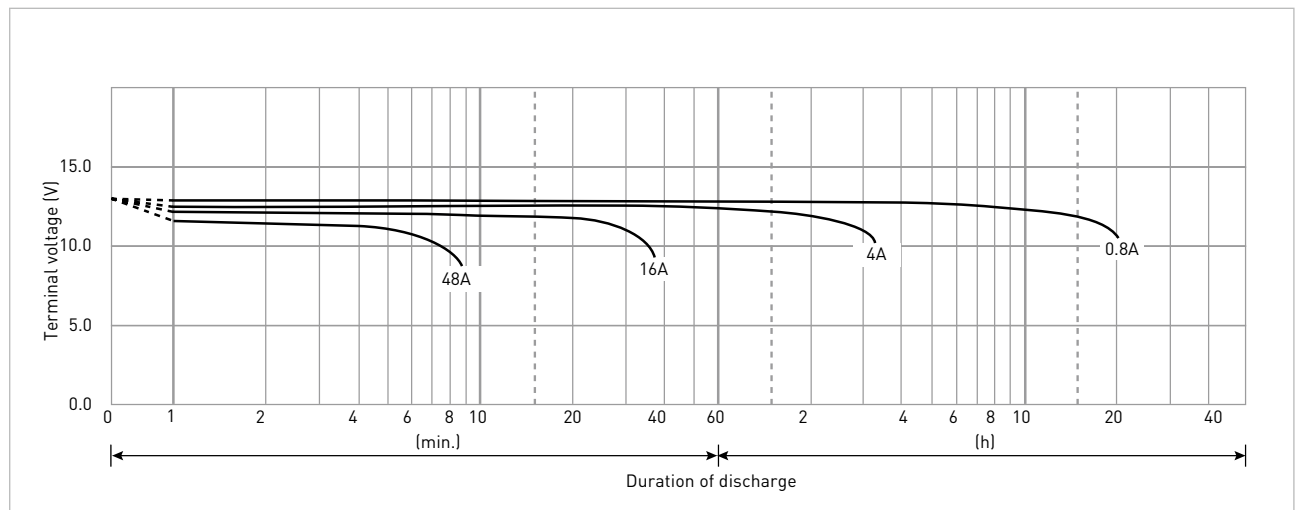

LC-XD1217PG/APG*1

FOR STANDBY POWER SUPPLIES.
EXPECTED TRICKLE DESIGN LIFE: 10 – 12 YEARS
AT 20°C ACCORDING TO EUROBAT.



G104101

DIMENSIONS (MM)



Terminal type (option)

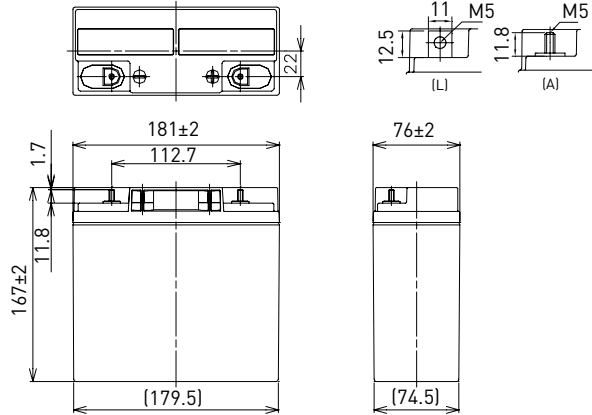

Contents indicated (including the recycle marking, etc.) are subject to change without notice. Battery case resin: standard (UL94 HB)

Specifications		LC-XD1217PG/APG*1
Nominal voltage (V)		12
Nominal capacity	20 hours rate (Ah)	17.0
Dimensions	Length (mm)	76
	Width (mm)	181
	Total height (mm)	167
Approx. mass (kg)		5.90
Terminal type	M5 bolt/nut & threaded post	
Capacity (25°C)	20 hours rate (Ah)	17.0
	10 hours rate (Ah)	16.0
	3 hours rate (Ah)	14.0
	1 hour rate (Ah)	12.0
Impedance (mΩ)	Fully charged battery (25°C)	12
	Temperature dependency of capacity (%) – 20 hours rate	
	40°C	102
	25°C	100
	0°C	85
	-15°C	65
Remaining capacity (25°C)	After 3 months (%)	91
	After 6 months (%)	82
	After 12 months (%)	64

DURATION OF DISCHARGE VS. DISCHARGE CURRENT

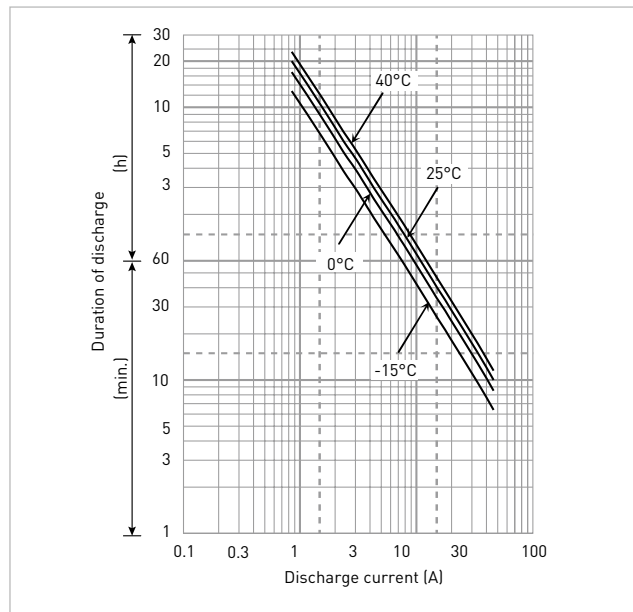

WATT TABLE (25°C)

(Wattage/battery)

Cut-off	3min.	5min.	10min.	15min.	20min.	30min.	45min.	1h	1.5h	2h	3h	4h	5h	6h	10h	20h
9.6V	1,021	806	526	402	337	251	177	142	97.6	75.5	56.2	43.2	35.6	28.6	19.0	10.3
9.9V	948	756	516	399	331	249	176	140	95.6	74.9	55.9	42.9	35.4	28.5	18.9	10.3
10.2V	874	708	502	391	326	246	175	139	93.7	73.0	55.4	42.6	35.1	28.3	18.7	10.2
10.5V	777	634	465	364	309	240	172	136	91.7	70.4	54.5	42.3	34.8	28.0	18.6	10.2
10.8V	656	561	415	339	301	232	169	134	89.2	67.1	53.4	41.8	33.9	27.5	18.4	10.1

AMPERE TABLE (25°C)

(Ampere/battery)

Cut-off	3min.	5min.	10min.	15min.	20min.	30min.	45min.	1h	1.5h	2h	3h	4h	5h	6h	10h	20h
9.6V	91.8	72.2	47.0	34.9	29.0	21.5	15.1	12.0	8.26	6.37	4.72	3.61	2.97	2.39	1.58	0.86
9.9V	85.2	67.8	46.0	34.7	28.6	21.2	15.0	11.9	8.10	6.33	4.70	3.59	2.95	2.38	1.57	0.85
10.2V	78.6	63.5	44.9	34.0	28.1	21.0	14.9	11.7	7.93	6.16	4.65	3.57	2.93	2.36	1.56	0.85
10.5V	69.9	56.9	41.6	31.6	26.7	20.5	14.6	11.6	7.77	5.95	4.58	3.54	2.90	2.33	1.55	0.85
10.8V	59.0	50.3	37.1	29.5	26.0	19.8	14.4	11.3	7.56	5.67	4.49	3.49	2.83	2.29	1.53	0.85

All mentioned values are average values

*1 This battery is also available with a flame-retardant battery case resin (UL94 V-0): LC-PD1217PG/APG.

LC-XD1217PG/APG*1

CHARGING METHOD (25°C)

Cycle use	Control voltage: 13.6V - 13.8V Initial current: 2.55A or smaller
------------------	---

CUT-OFF VOLTAGE

Discharge current	0.850A - 3.40A	3.40A - 8.50A	8.50A - 17.0A	17.0A - 34.0A	34.0A - 51.0A
Cut-off voltage	10.5V	10.2V	9.9V	9.3V	8.7V

INFLUENCE OF TEMPERATURE ON TRICKLE LIFE

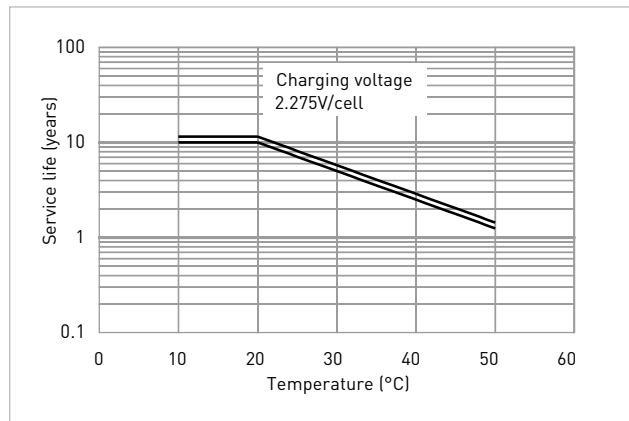

RESIDUAL CAPACITY TEST RESULT

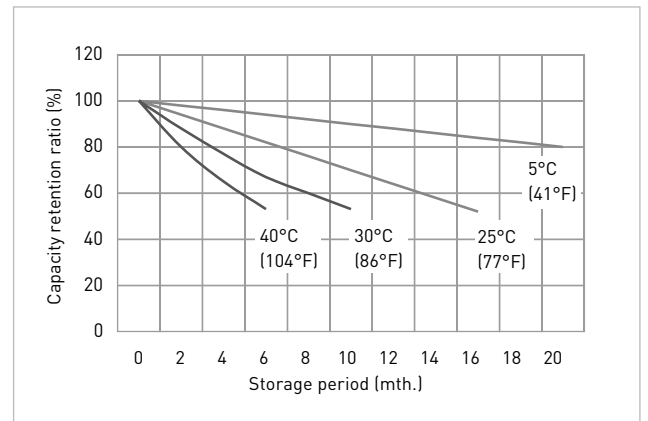

CONSTANT-VOLTAGE CONSTANT-CURRENT CHARGE CHARACTERISTICS FOR TRICKLE USE

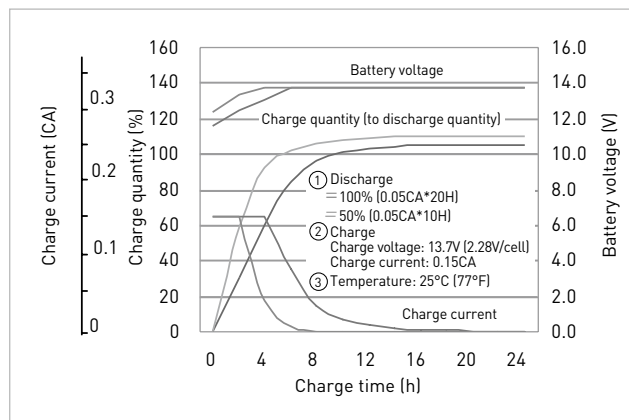

DISCHARGE CAPACITY BY TEMPERATURE AND BY DISCHARGE CURRENT

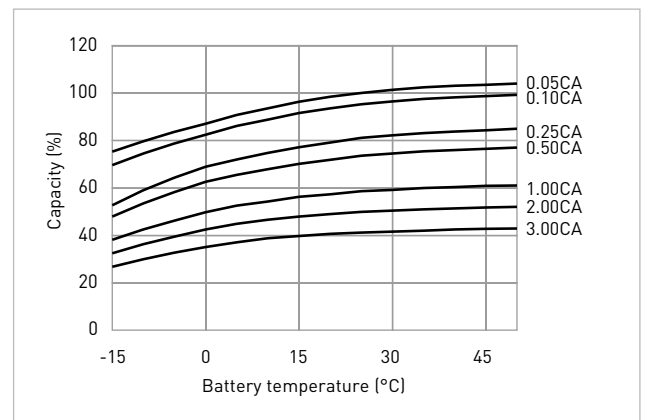

DISCHARGE CHARACTERISTICS

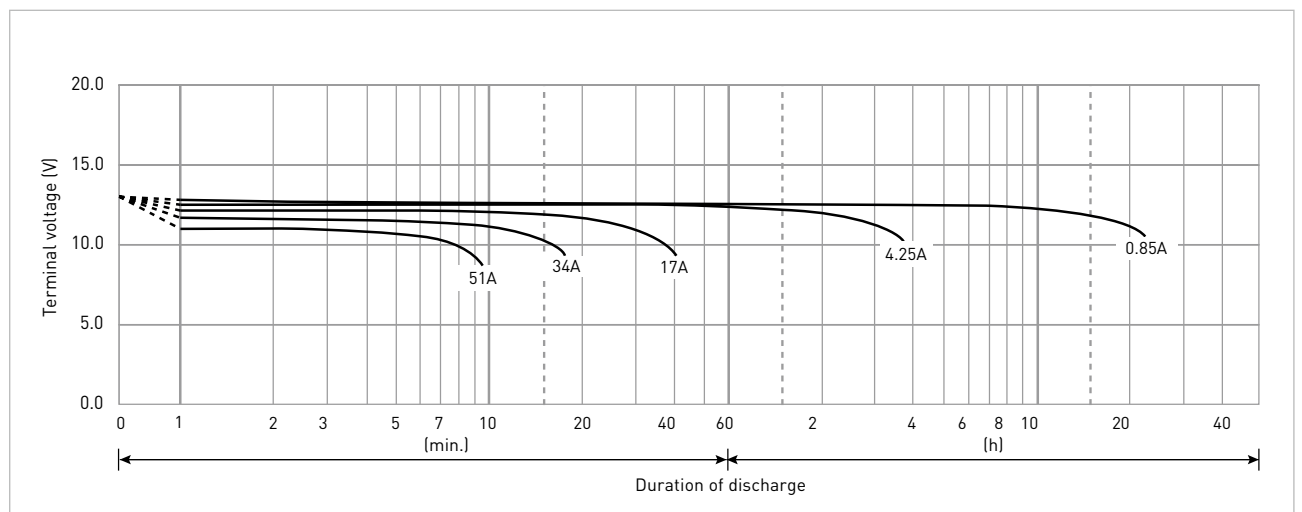

*1 This battery is also available with a flame-retardant battery case resin (UL94 V-0): LC-PD1217PG/APG.

LC-P1220P/AP

FOR STANDBY POWER SUPPLIES.
 EXPECTED TRICKLE DESIGN LIFE: 10 – 12 YEARS AT 20°C
 ACCORDING TO EUROBAT.

DIMENSIONS (MM)



Terminal type (option)

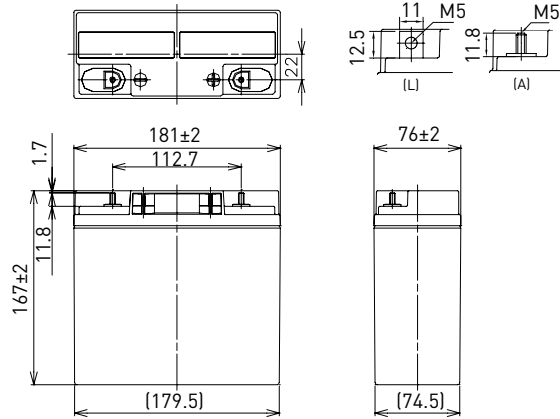

Contents indicated (including the recycle marking, etc.) are subject to change without notice. Battery case resin: flame-retardant (UL94 V-0)

Specifications		LC-P1220P/AP
Nominal voltage (V)		12
Nominal capacity	20 hours rate (Ah)	20.0
Dimensions	Length (mm)	76
	Width (mm)	181
	Total height (mm)	167
Approx. mass (kg)		5.90
Terminal type		M5 bolt/nut & threaded post
Capacity (25°C)	20 hours rate (Ah)	20.0
	10 hours rate (Ah)	17.0
	3 hours rate (Ah)	15.0
	1 hour rate (Ah)	12.0
Impedance (mΩ)		Fully charged battery (25°C) 15
Temperature dependency of capacity (%) – 20 hours rate	40°C	102
	25°C	100
	0°C	85
	-15°C	65
Remaining capacity (25°C)	After 3 months (%)	91
	After 6 months (%)	82
	After 12 months (%)	64

DURATION OF DISCHARGE VS. DISCHARGE CURRENT

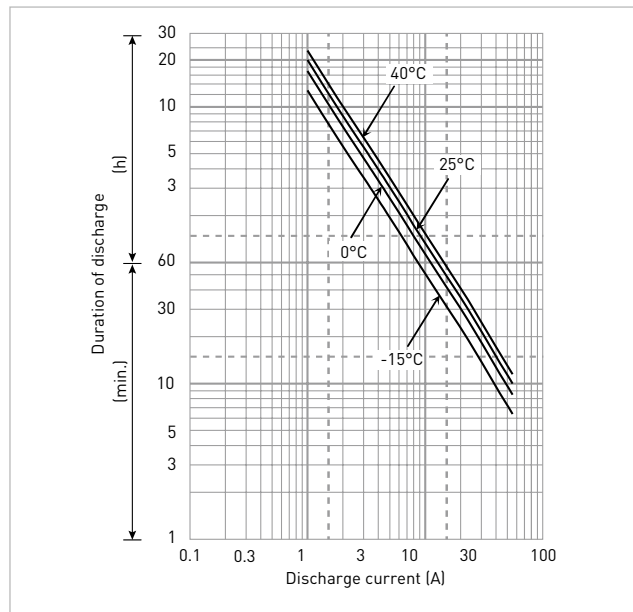

WATT TABLE (25°C)

(Wattage/battery)

Cut-off	5min.	10min.	15min.	20min.	30min.	45min.	1h	1.5h	2h	3h	4h	5h	6h	10h	20h
9.6V	853	557	425	357	266	188	150	103	83.1	61.9	47.5	39.2	31.5	21.6	11.7
9.9V	800	546	423	351	263	186	148	101	82.5	61.5	47.2	38.9	31.4	21.5	11.7
10.2V	750	532	414	345	260	185	146	99.1	80.3	60.9	46.9	38.6	31.2	21.3	11.6
10.5V	672	493	385	328	254	182	145	97.0	77.5	60.0	46.6	38.3	30.8	21.2	11.6
10.8V	594	440	359	319	246	179	141	94.3	73.9	58.8	46.0	37.4	30.3	21.0	11.5

AMPERE TABLE (25°C)

(Ampere/battery)

Cut-off	5min.	10min.	15min.	20min.	30min.	45min.	1h	1.5h	2h	3h	4h	5h	6h	10h	20h
9.6V	85.0	55.3	40.0	34.2	24.0	16.9	12.7	9.04	6.98	5.17	3.95	3.26	2.61	1.75	1.01
9.9V	79.7	54.2	39.7	33.6	23.7	16.8	12.6	8.86	6.92	5.14	3.93	3.23	2.60	1.75	1.01
10.2V	74.7	52.8	38.9	33.1	23.5	16.6	12.4	8.68	6.74	5.09	3.90	3.20	2.58	1.73	1.00
10.5V	66.9	48.9	36.2	31.4	22.9	16.4	12.2	8.50	6.51	5.01	3.88	3.18	2.55	1.72	1.00
10.8V	59.2	43.6	33.8	30.6	22.2	16.1	12.0	8.27	6.20	4.91	3.82	3.10	2.51	1.70	0.994

All mentioned values are average values

LC-P1220P/AP

CHARGING METHOD (25°C)

Cycle use	Control voltage: 13.6V - 13.8V Initial current: 3.00A or smaller
------------------	---

CUT-OFF VOLTAGE

Discharge current	1.00A - 4.00A	4.00A - 10.0A	10.0A - 20.0A	20.0A - 40.0A	40.0A - 60.0A
Cut-off voltage	10.5V	10.2V	9.9V	9.3V	8.7V

INFLUENCE OF TEMPERATURE ON TRICKLE LIFE

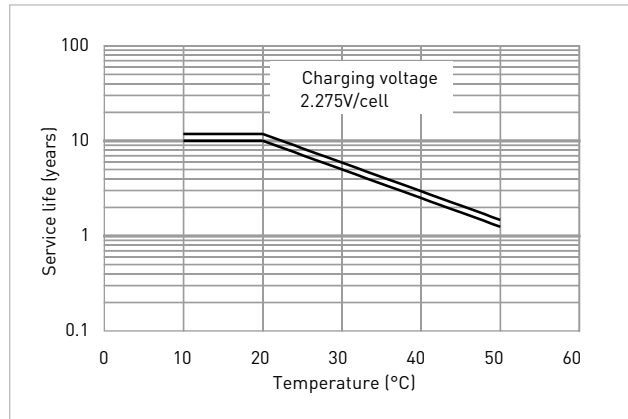

RESIDUAL CAPACITY TEST RESULT

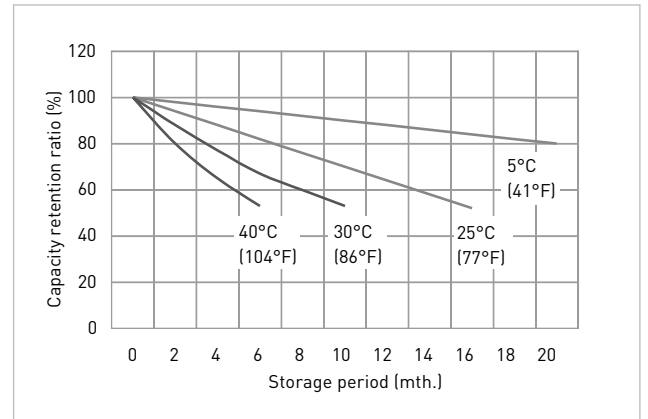

CONSTANT-VOLTAGE CONSTANT-CURRENT CHARGE CHARACTERISTICS FOR TRICKLE USE

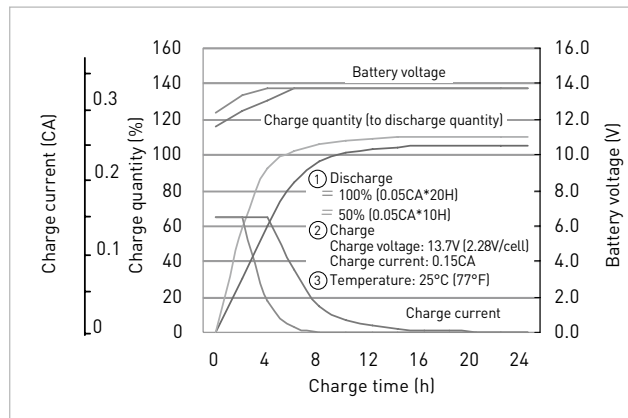

DISCHARGE CAPACITY BY TEMPERATURE AND BY DISCHARGE CURRENT

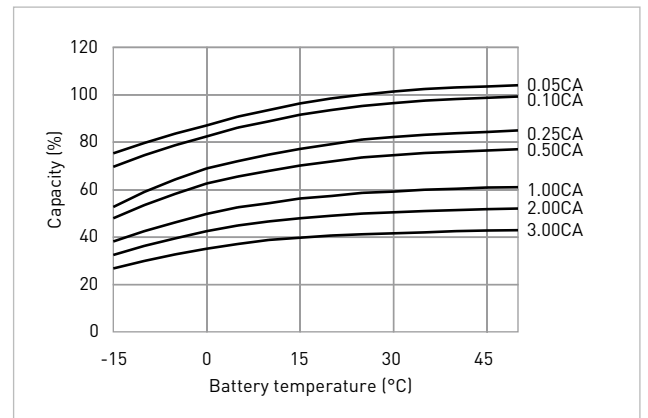

DISCHARGE CHARACTERISTICS

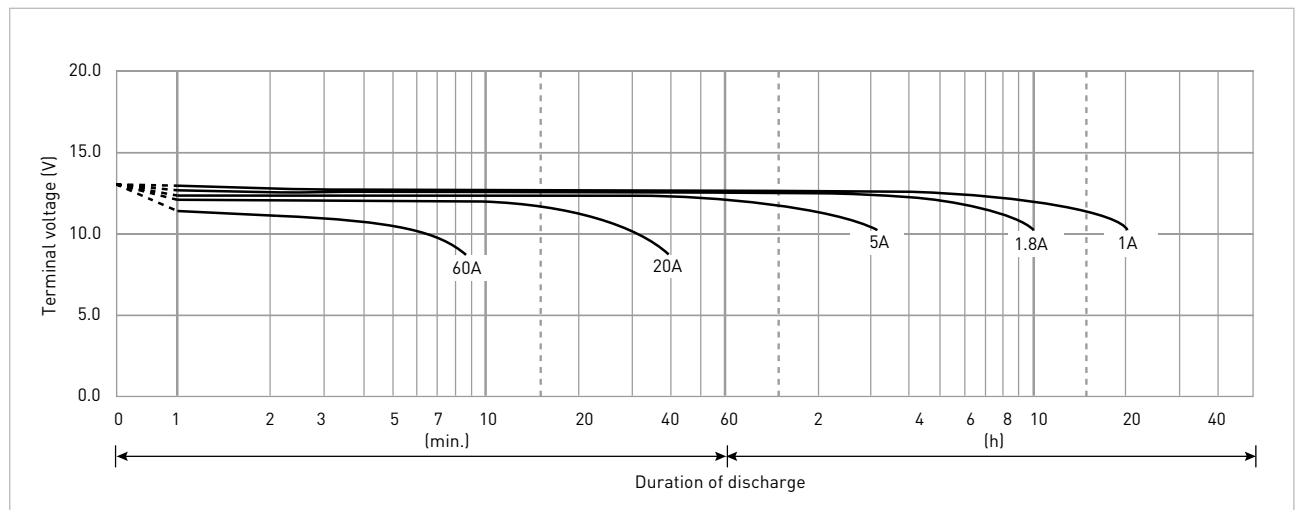

LC-P1224PG/APG

FOR STANDBY POWER SUPPLIES.
 EXPECTED TRICKLE DESIGN LIFE: 10 – 12 YEARS
 AT 20°C ACCORDING TO EUROBAT.



G198049

DIMENSIONS (MM)



Terminal type (option)

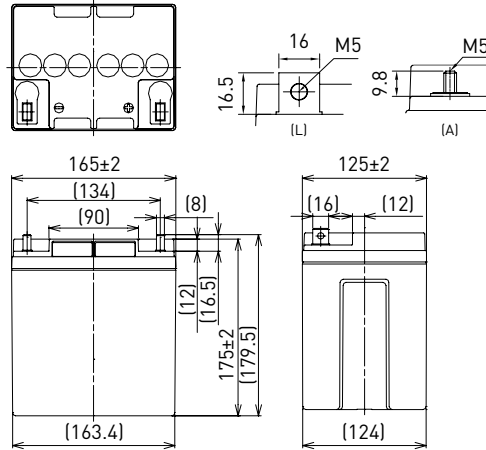

Contents indicated (including the recycle marking, etc.) are subject to change without notice. Battery case resin: flame-retardant (UL94 V-0)

Specifications		LC-P1224PG/APG
Nominal voltage (V)		12
Nominal capacity	20 hours rate (Ah)	24.0
Dimensions	Length (mm)	125
	Width (mm)	165
	Total height (mm)	179.5/175
Approx. mass (kg)		8.05
Terminal type		M5 bolt/nut & threaded post
Capacity (25°C)	20 hours rate (Ah)	24.0
	10 hours rate (Ah)	22.0
	3 hours rate (Ah)	18.0
	1 hour rate (Ah)	14.0
Impedance (mΩ) Fully charged battery (25°C)		11
Temperature dependency of capacity (%) – 20 hours rate	40°C	102
	25°C	100
	0°C	85
	-15°C	65
Remaining capacity (25°C)	After 3 months (%)	91
	After 6 months (%)	82
	After 12 months (%)	64

DURATION OF DISCHARGE VS. DISCHARGE CURRENT

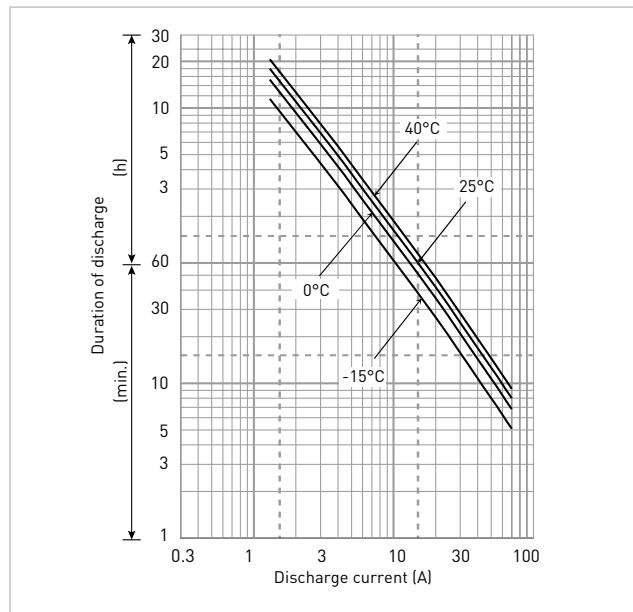

WATT TABLE (25°C)

(Wattage/battery)

Cut-off	5min.	10min.	15min.	20min.	30min.	45min.	1h	1.5h	2h	3h	4h	5h	6h	10h	20h
9.6V	992	739	523	441	317	234	183	118	104	73.8	58.6	47.9	40.8	26.4	14.6
9.9V	931	724	520	434	314	232	181	116	103	73.4	58.2	47.5	40.6	26.3	14.6
10.2V	872	706	509	426	310	230	179	113	101	72.7	57.8	47.2	40.3	26.0	14.5
10.5V	782	654	474	405	303	226	175	111	97.2	71.6	57.4	46.8	39.8	25.9	14.4
10.8V	691	583	442	394	293	223	172	108	92.6	70.1	56.6	45.6	39.2	25.6	14.3

AMPERE TABLE (25°C)

(Ampere/battery)

Cut-off	5min.	10min.	15min.	20min.	30min.	45min.	1h	1.5h	2h	3h	4h	5h	6h	10h	20h
9.6V	89.0	66.0	45.5	38.0	27.1	19.9	14.6	10.0	8.80	6.20	4.90	3.89	3.40	2.27	1.23
9.9V	83.5	64.7	45.2	37.4	26.8	19.8	14.5	9.80	8.73	6.17	4.87	3.86	3.39	2.26	1.22
10.2V	78.2	63.0	44.3	36.8	26.5	19.6	14.3	9.60	8.51	6.11	4.84	3.83	3.36	2.23	1.21
10.5V	70.1	58.4	41.2	34.9	25.9	19.3	14.0	9.40	8.21	6.01	4.80	3.80	3.32	2.22	1.20
10.8V	62.0	52.1	38.4	34.0	25.0	19.0	13.7	9.14	7.82	5.89	4.74	3.71	3.27	2.20	1.19

All mentioned values are average values

LC-P1224PG/APG

CHARGING METHOD (25°C)

Cycle use	Control voltage: 13.6V - 13.8V Initial current: 3.6A or smaller
------------------	--

CUT-OFF VOLTAGE

Discharge current	1.2A - 4.8A	4.8A - 12A	12A - 24A	24A - 48A	48A - 72A
Cut-off voltage	10.5V	10.2V	9.9V	9.3V	8.7V

INFLUENCE OF TEMPERATURE ON TRICKLE LIFE

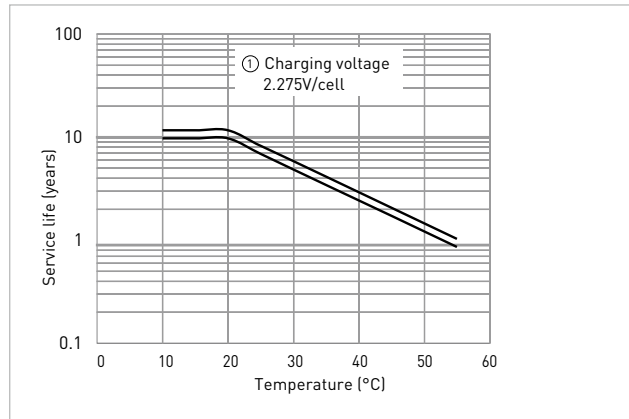

RESIDUAL CAPACITY VS. STORAGE PERIOD

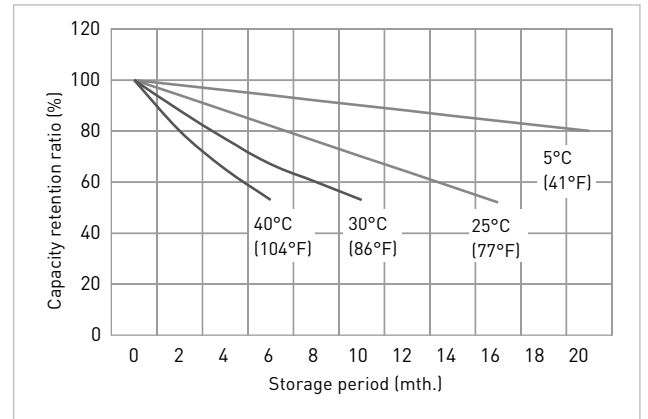

CONSTANT-VOLTAGE CONSTANT-CURRENT CHARGE CHARACTERISTICS FOR TRICKLE USE

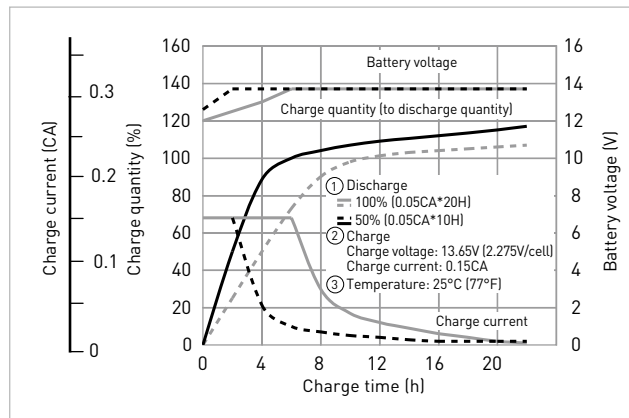

DISCHARGE CAPACITY BY TEMPERATURE AND BY DISCHARGE CURRENT

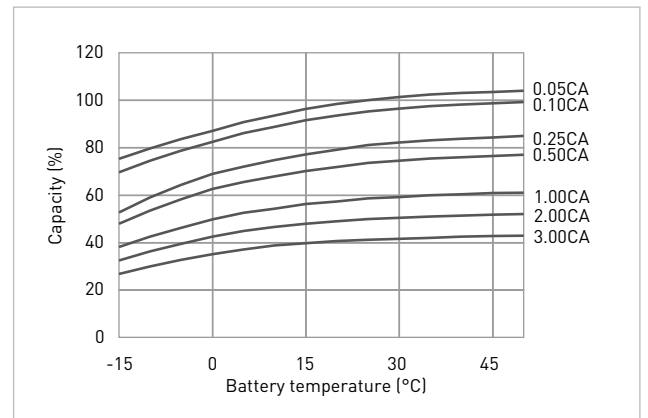

DISCHARGE CHARACTERISTICS

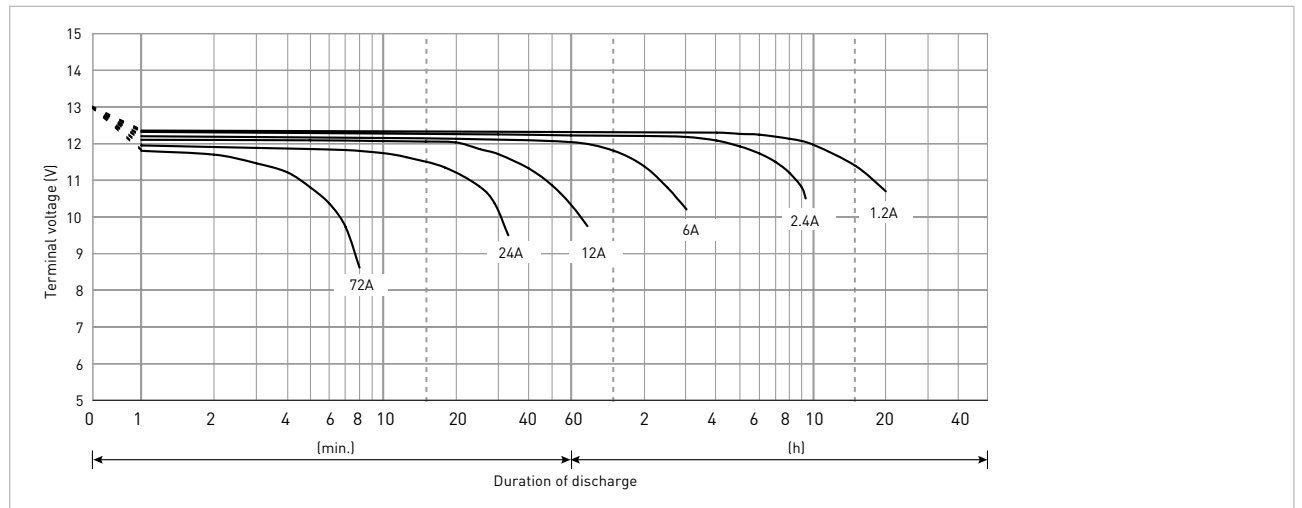

LC-P1228P/AP

FOR STANDBY POWER SUPPLIES.
 EXPECTED TRICKLE DESIGN LIFE: 10 – 12 YEARS AT 20°C
 ACCORDING TO EUROBAT.

DIMENSIONS (MM)



Terminal type (option)

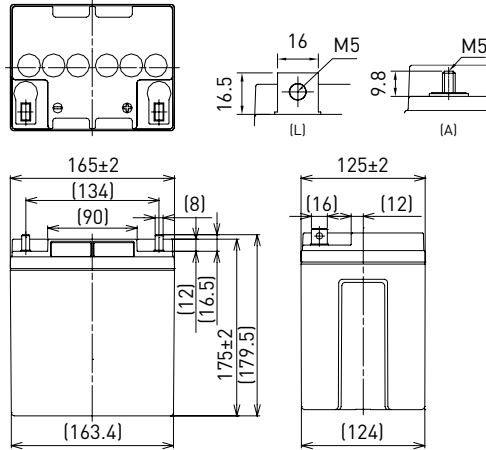

Contents indicated (including the recycle marking, etc.) are subject to change without notice. Battery case resin: flame-retardant (UL94 V-0)

Specifications		LC-P1228P/AP
Nominal voltage (V)		12
Nominal capacity	20 hours rate (Ah)	28.0
Dimensions	Length (mm)	125
	Width (mm)	165
	Total height (mm)	179.5/175
Approx. mass (kg)		9.40
Terminal type	M5 bolt/nut & threaded post	
Capacity (25°C)	20 hours rate (Ah)	28.0
	10 hours rate (Ah)	26.0
	3 hours rate (Ah)	22.0
	1 hour rate (Ah)	21.0
Impedance (mΩ)	Fully charged battery (25°C)	11
	Temperature dependency of capacity (%) – 20 hours rate	
	40°C	102
	25°C	100
	0°C	85
	-15°C	65
Remaining capacity (25°C)	After 3 months (%)	91
	After 6 months (%)	82
	After 12 months (%)	64

DURATION OF DISCHARGE VS. DISCHARGE CURRENT

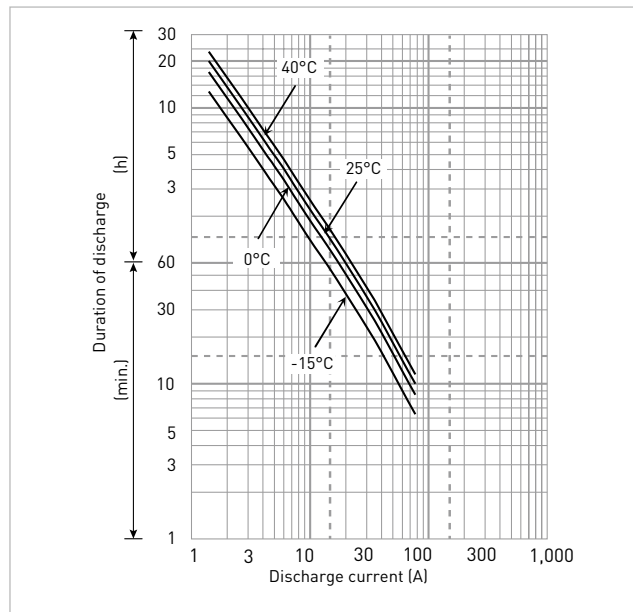

WATT TABLE (25°C)

(Wattage/battery)

Cut-off	5min.	10min.	15min.	20min.	30min.	45min.	1h	1.5h	2h	3h	4h	5h	6h	10h	20h
9.6V	1,160	865	664	585	410	304	260	159	129	91.6	74.1	61.1	50.8	31.8	16.8
9.9V	1,093	849	654	579	404	294	254	156	128	90.4	72.9	60.8	50.4	31.8	16.8
10.2V	1,026	818	643	567	397	288	251	155	127	89.3	71.7	60.5	49.9	31.8	16.8
10.5V	976	784	621	545	386	282	247	154	126	88.1	71.1	60.2	49.5	31.8	16.8
10.8V	903	773	610	539	374	255	218	149	118	84.5	70.5	59.9	49.0	31.8	16.8

AMPERE TABLE (25°C)

(Ampere/battery)

Cut-off	5min.	10min.	15min.	20min.	30min.	45min.	1h	1.5h	2h	3h	4h	5h	6h	10h	20h
9.6V	104	77.2	57.7	50.4	35.0	25.9	22.1	13.5	10.9	7.70	6.20	5.10	4.30	2.60	1.40
9.9V	98.0	75.8	56.9	49.9	34.5	25.0	21.6	13.2	10.8	7.60	6.10	5.06	4.28	2.60	1.40
10.2V	92.0	73.0	55.9	48.9	33.9	24.5	21.3	13.1	10.7	7.50	6.00	5.03	4.25	2.60	1.40
10.5V	87.5	70.0	54.0	47.0	33.0	24.0	21.0	13.0	10.6	7.40	5.95	4.99	4.23	2.60	1.40
10.8V	81.0	69.0	53.0	46.5	32.0	21.7	18.5	12.6	10.0	7.10	5.90	4.95	4.20	2.60	1.40

All mentioned values are average values

LC-P1228P/AP

CHARGING METHOD (25°C)

Cycle use	Control voltage: 13.6V - 13.8V Initial current: 4.20A or smaller
------------------	---

CUT-OFF VOLTAGE

Discharge current	1.40A - 5.60A	5.60A - 14.0A	14.0A - 28.0A	28.0A - 56.0A	56.0A - 84A
Cut-off voltage	10.5V	10.2V	9.9V	9.3V	8.7V

INFLUENCE OF TEMPERATURE ON TRICKLE LIFE

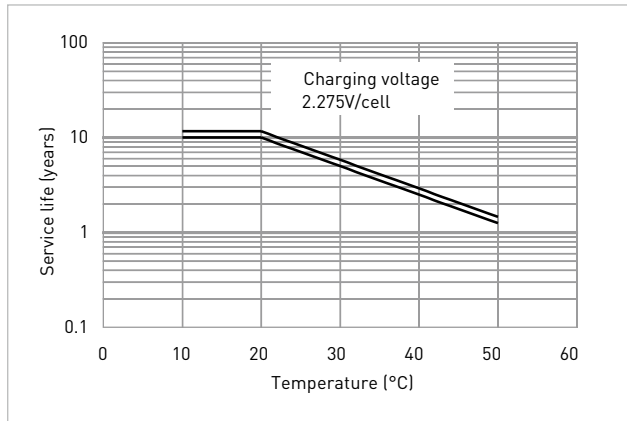

RESIDUAL CAPACITY TEST RESULT

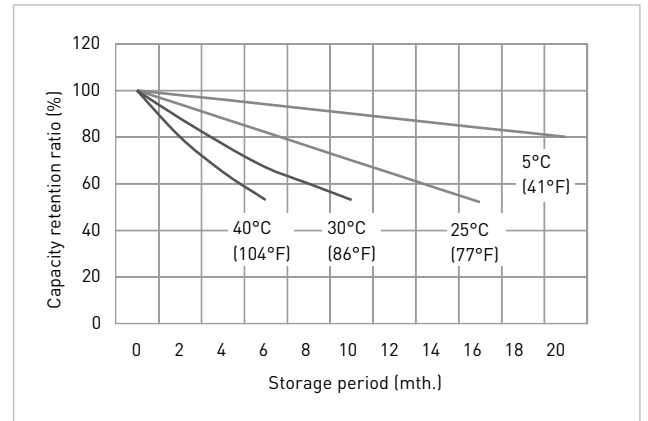

CONSTANT-VOLTAGE CONSTANT-CURRENT CHARGE CHARACTERISTICS FOR TRICKLE USE

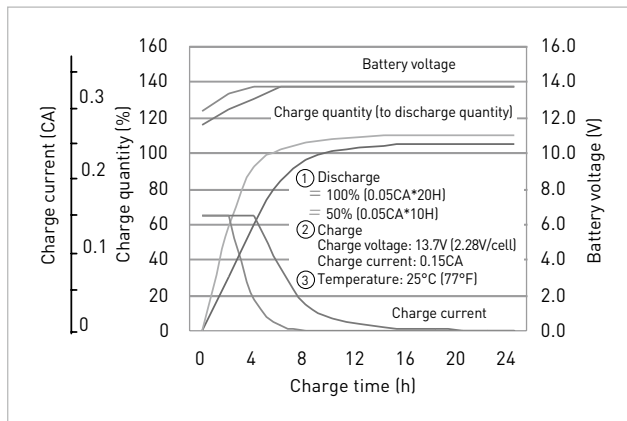

DISCHARGE CAPACITY BY TEMPERATURE AND BY DISCHARGE CURRENT

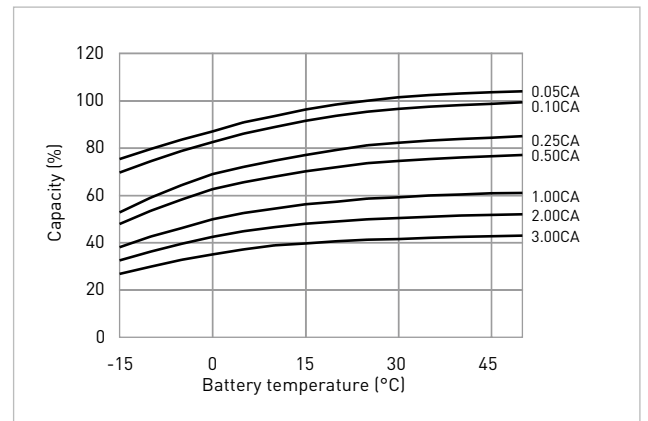

DISCHARGE CHARACTERISTICS

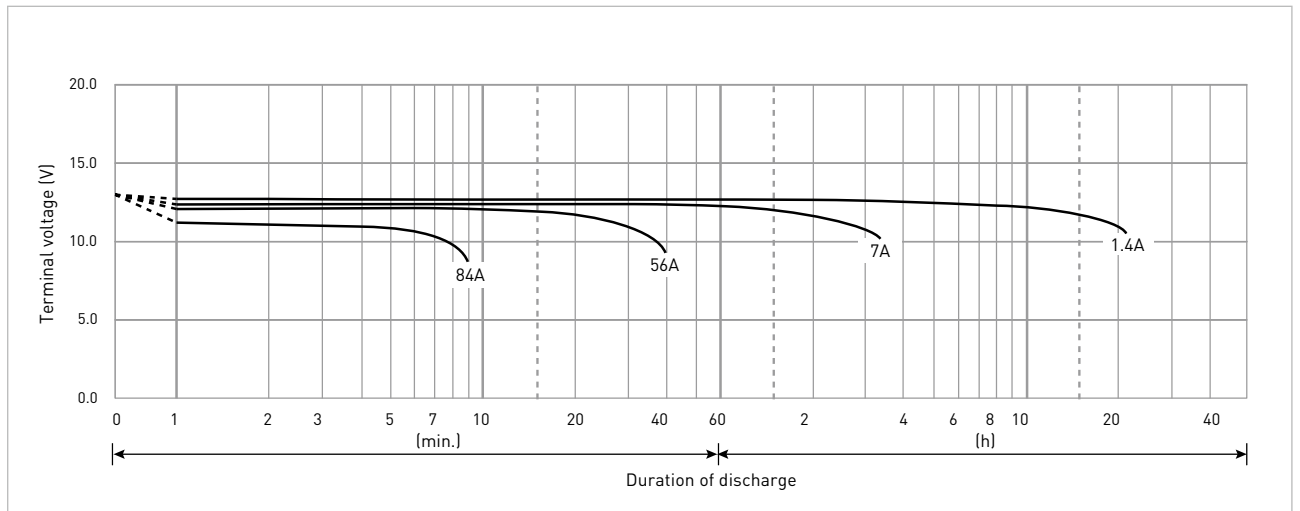

LC-P1238PG/APG

FOR STANDBY POWER SUPPLIES.
 EXPECTED TRICKLE DESIGN LIFE: 10 – 12 YEARS
 AT 20°C ACCORDING TO EUROBAT.



G100002

DIMENSIONS (MM)

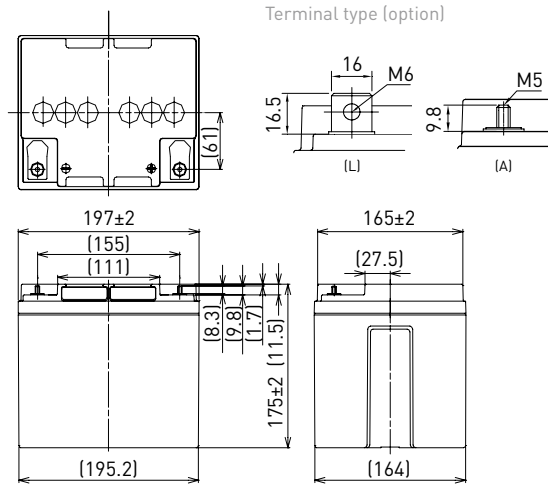

Contents indicated (including the recycle marking, etc.) are subject to change without notice. Battery case resin: flame-retardant (UL94 V-0)

Specifications		LC-P1238PG/APG
Nominal voltage [V]		12
Nominal capacity	20 hours rate (Ah)	38.0
Dimensions	Length (mm)	165
	Width (mm)	197
	Total height (mm)	180/175
Approx. mass (kg)		12.5
Terminal type	M6 bolt/nut & M5 threaded post	
Capacity [25°C]	20 hours rate (Ah)	38.0
	10 hours rate (Ah)	36.0
	3 hours rate (Ah)	29.0
	1 hour rate (Ah)	23.0
Impedance (mΩ)	Fully charged battery [25°C]	10
	40°C	102
Temperature dependency of capacity (%) – 20 hours rate	25°C	100
	0°C	85
	-15°C	65
	After 3 months [%]	91
Remaining capacity [25°C]	After 6 months [%]	82
	After 12 months [%]	64

DURATION OF DISCHARGE VS. DISCHARGE CURRENT

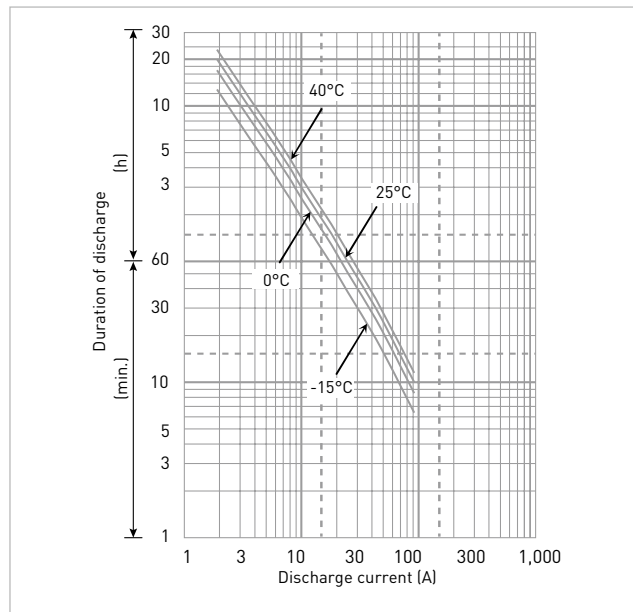

WATT TABLE (25°C)

(Wattage/battery)

Cut-off	5min.	10min.	15min.	20min.	30min.	45min.	1h	1.5h	2h	3h	4h	5h	6h	10h	20h
9.6V	1,349	1,030	800	686	505	351	276	214	169	123	99.2	77.9	68.3	42.0	22.8
9.9V	1,271	1,008	788	682	500	350	269	209	168	120	98.0	76.7	68.0	42.0	22.8
10.2V	1,204	980	768	672	489	349	267	185	167	119	96.8	75.5	67.7	42.0	22.8
10.5V	1,126	952	748	661	480	346	265	183	166	117	95.6	74.9	67.4	42.0	22.8
10.8V	1,098	874	716	640	468	308	247	175	155	114	94.4	74.3	67.1	42.0	22.8

AMPERE TABLE (25°C)

(Ampere/battery)

Cut-off	5min.	10min.	15min.	20min.	30min.	45min.	1h	1.5h	2h	3h	4h	5h	6h	10h	20h
9.6V	121	92.0	69.6	59.1	43.2	29.9	23.4	18.1	14.3	10.3	8.30	6.50	5.70	3.60	1.90
9.9V	114	90.0	68.5	58.8	42.7	29.8	22.8	17.7	14.2	10.1	8.20	6.40	5.68	3.60	1.90
10.2V	108	87.5	66.8	57.9	41.8	29.7	22.7	15.7	14.1	10.0	8.10	6.30	5.66	3.60	1.90
10.5V	101	85.0	65.0	57.0	41.0	29.5	22.5	15.5	14.0	9.80	8.00	6.25	5.64	3.60	1.90
10.8V	98.5	78.0	62.3	55.2	40.0	26.2	21.0	14.8	13.1	9.60	7.90	6.20	5.60	3.60	1.90

All mentioned values are average values

LC-P1238PG/APG

CHARGING METHOD (25°C)

Cycle use	Control voltage: 13.6V - 13.8V Initial current: 5.70A or smaller
------------------	---

CUT-OFF VOLTAGE

Discharge current	1.90A - 7.60A	7.60A - 19.0A	19.0A - 38.0A	38.0A - 76.0A	76.0A - 114A
Cut-off voltage	10.5V	10.2V	9.9V	9.3V	8.7V

INFLUENCE OF TEMPERATURE ON TRICKLE LIFE

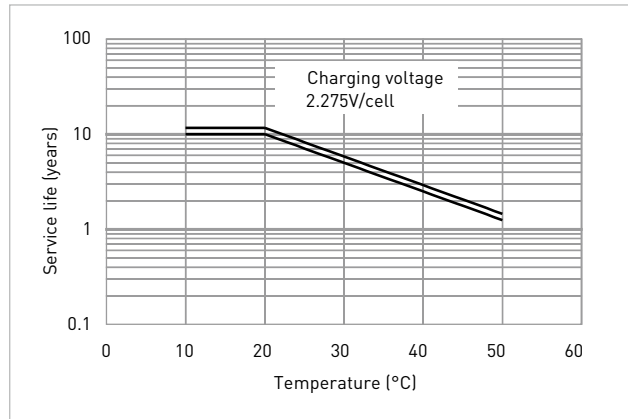

RESIDUAL CAPACITY TEST RESULT

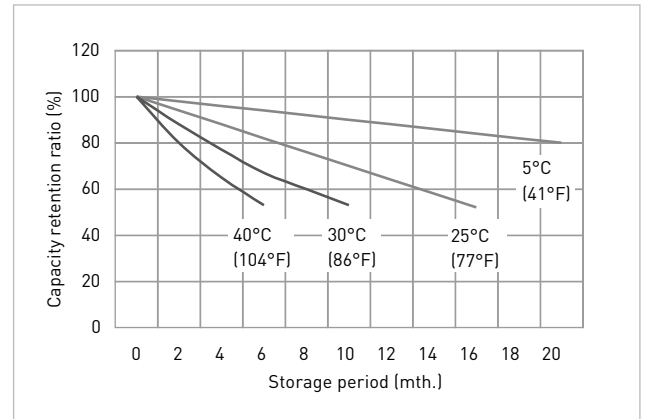

CONSTANT-VOLTAGE CONSTANT-CURRENT CHARGE CHARACTERISTICS FOR TRICKLE USE

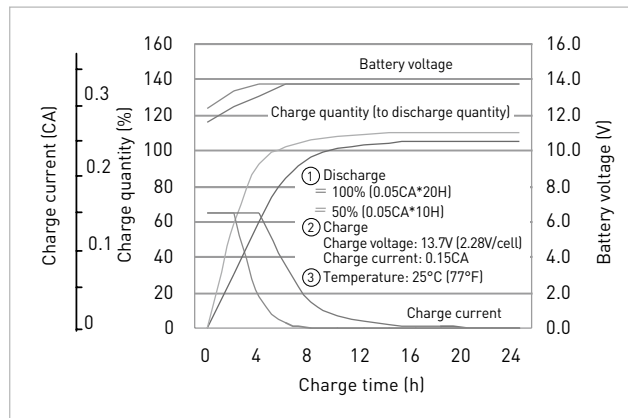

DISCHARGE CAPACITY BY TEMPERATURE AND BY DISCHARGE CURRENT

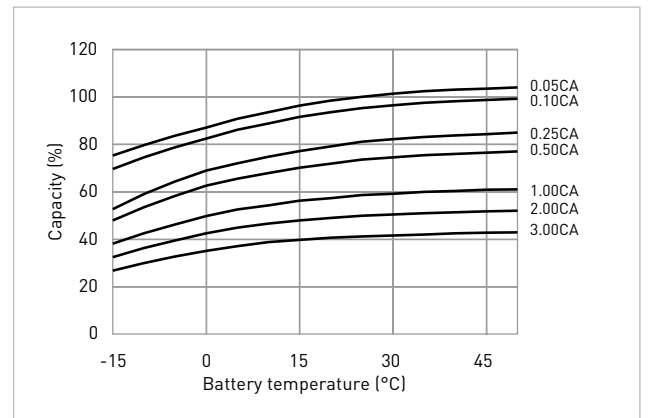

DISCHARGE CHARACTERISTICS

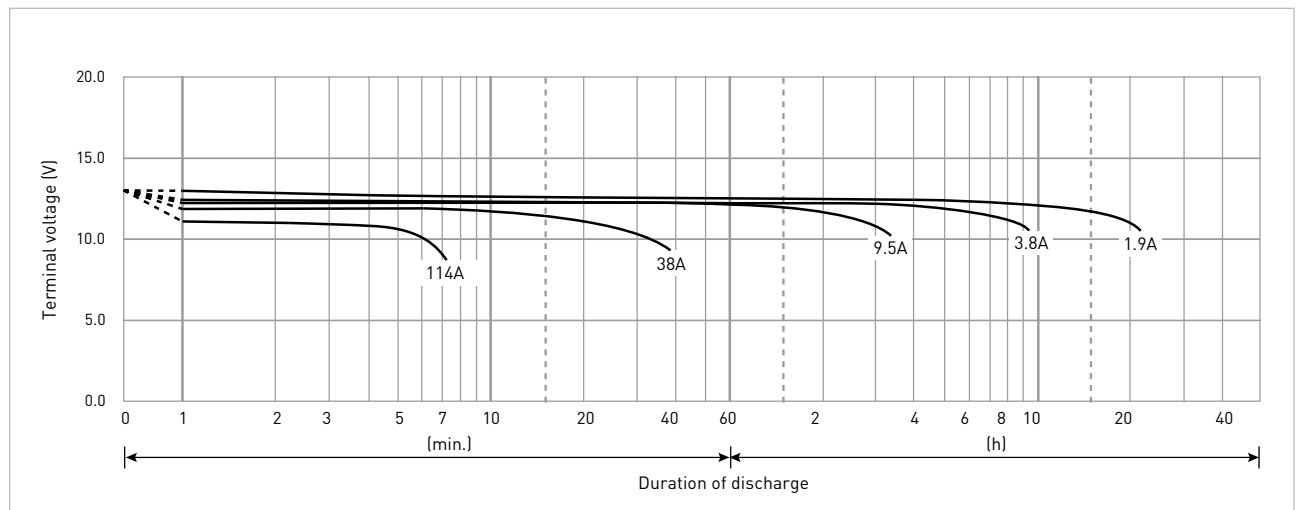

LC-P1242P/AP

DIMENSIONS (MM)



Contents indicated (including the recycle marking, etc.) are subject to change without notice. Battery case resin: flame-retardant (UL94 V-0)

FOR STANDBY POWER SUPPLIES.
EXPECTED TRICKLE DESIGN LIFE: 10 – 12 YEARS AT 20°C
ACCORDING TO EUROBAT.

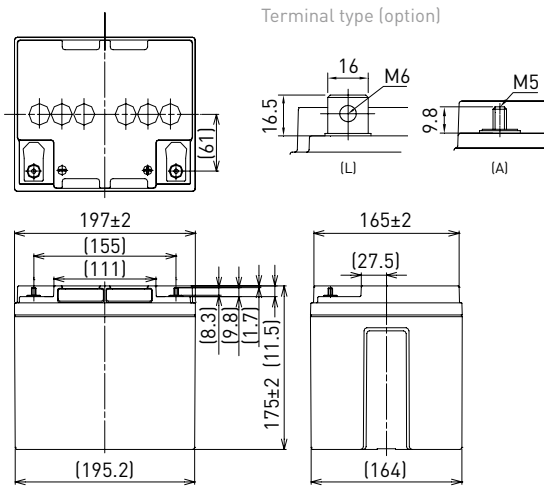

Specifications		LC-P1242P/AP
Nominal voltage [V]		12
Nominal capacity	20 hours rate (Ah)	42.0
Dimensions	Length (mm)	165
	Width (mm)	197
	Total height (mm)	180/175
Approx. mass (kg)		13.5
Terminal type		M6 bolt/nut & M5 threaded post
Capacity [25°C]	20 hours rate (Ah)	42.0
	10 hours rate (Ah)	40.0
	3 hours rate (Ah)	32.0
	1 hour rate (Ah)	26.0
Impedance (mΩ) Fully charged battery [25°C]		10
Temperature dependency of capacity (%) – 20 hours rate	40°C	102
	25°C	100
	0°C	85
	-15°C	65
Remaining capacity [25°C]	After 3 months (%)	91
	After 6 months (%)	82
	After 12 months (%)	64

DURATION OF DISCHARGE VS. DISCHARGE CURRENT

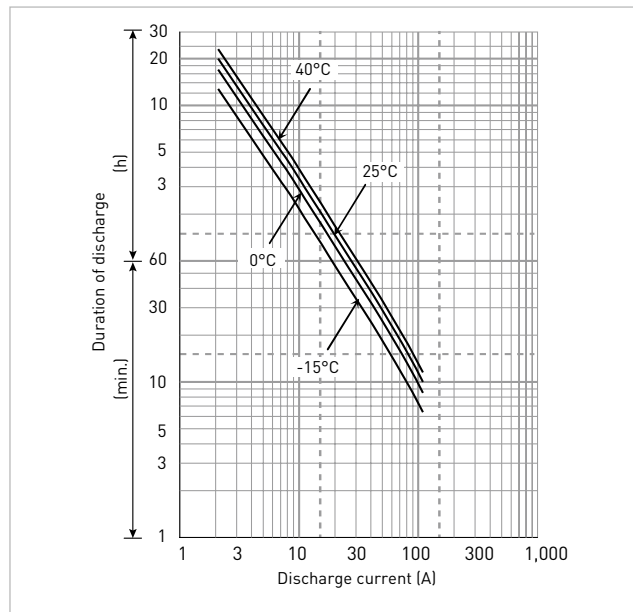

WATT TABLE (25°C)

(Wattage/battery)

Cut-off	5min.	10min.	15min.	20min.	30min.	45min.	1h	1.5h	2h	3h	4h	5h	6h	10h	20h
9.6V	1,483	1,254	966	835	625	410	312	241	187	132	110	89.9	79.1	48.0	25.2
9.9V	1,405	1,232	955	824	607	407	310	234	186	130	109	89.4	78.5	48.0	25.2
10.2V	1,327	1,210	943	812	596	406	307	217	184	127	108	88.9	77.9	48.0	25.2
10.5V	1,249	1,176	920	800	585	405	306	211	179	126	107	88.5	76.7	48.0	25.2
10.8V	1,215	1,086	886	777	573	390	295	201	173	121	105	87.5	75.5	48.0	25.2

AMPERE TABLE (25°C)

(Ampere/battery)

Cut-off	5min.	10min.	15min.	20min.	30min.	45min.	1h	1.5h	2h	3h	4h	5h	6h	10h	20h
9.6V	133	112	84.0	72.0	53.4	34.9	26.5	20.4	15.8	11.1	9.20	7.50	6.60	4.00	2.10
9.9V	126	110	83.0	71.0	51.9	34.7	26.3	19.8	15.7	10.9	9.10	7.46	6.50	4.00	2.10
10.2V	119	108	82.0	70.0	50.9	34.6	26.1	18.4	15.5	10.7	9.00	7.42	6.50	4.00	2.10
10.5V	112	105	80.0	69.0	50.0	34.5	26.0	17.9	15.1	10.6	8.90	7.38	6.40	4.00	2.10
10.8V	109	97.0	77.0	67.0	49.0	33.2	25.0	17.0	14.6	10.2	8.80	7.30	6.30	4.00	2.10

All mentioned values are average values

LC-P1242P/AP

CHARGING METHOD (25°C)

Cycle use	Control voltage: 13.6V - 13.8V Initial current: 6.30A or smaller
------------------	---

CUT-OFF VOLTAGE

Discharge current	2.10A - 8.40A	8.40A - 21.0A	21.0A - 42.0A	42.0A - 84.0A	84.0A - 126A
Cut-off voltage	10.5V	10.2V	9.9V	9.3V	8.7V

INFLUENCE OF TEMPERATURE ON TRICKLE LIFE

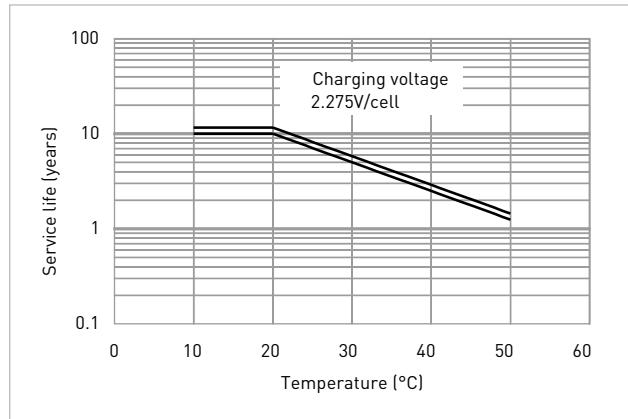

RESIDUAL CAPACITY TEST RESULT

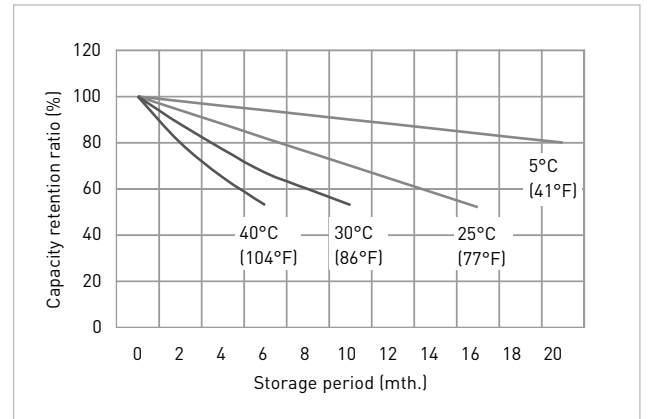

CONSTANT-VOLTAGE CONSTANT-CURRENT CHARGE CHARACTERISTICS FOR TRICKLE USE

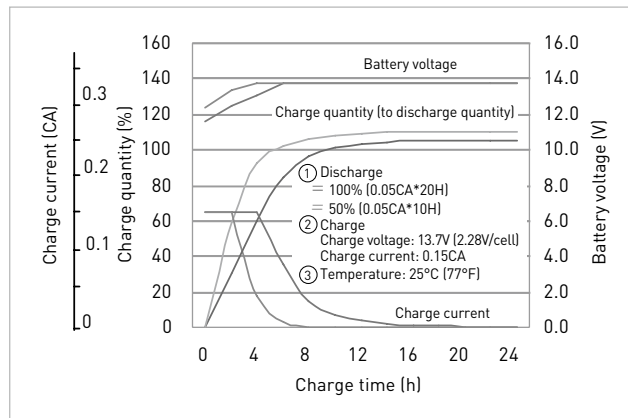

DISCHARGE CAPACITY BY TEMPERATURE AND BY DISCHARGE CURRENT

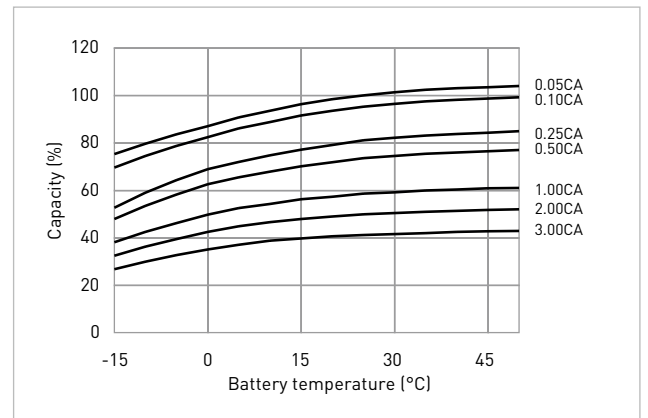

DISCHARGE CHARACTERISTICS

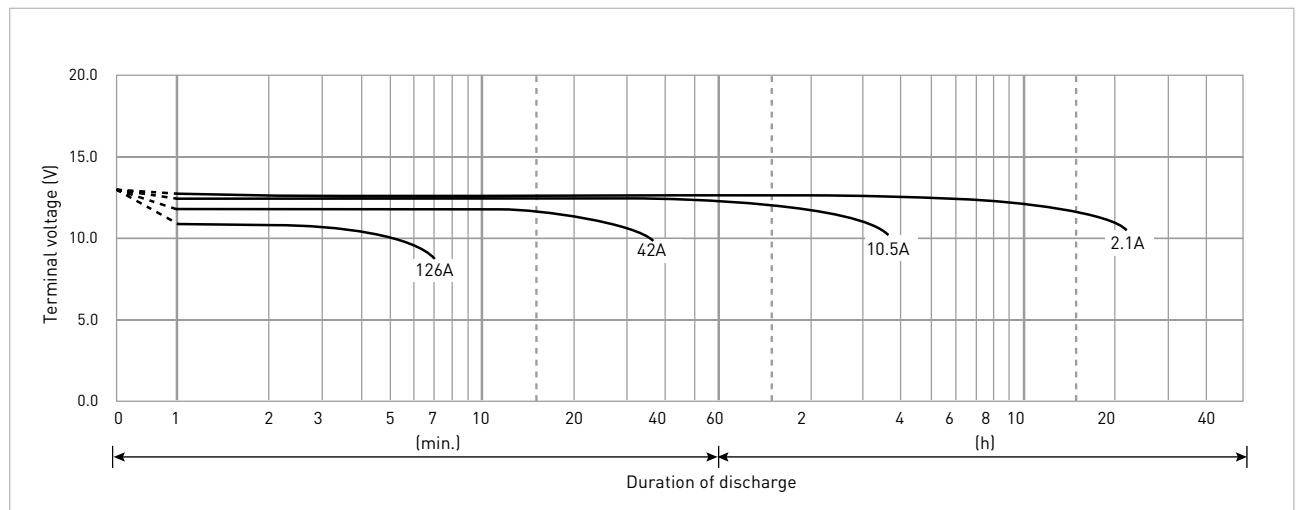

LC-X1265PG*1

FOR STANDBY POWER SUPPLIES.
EXPECTED TRICKLE DESIGN LIFE: 10 – 12 YEARS
AT 20°C ACCORDING TO EUROBAT.



G199090

DIMENSIONS (MM)



Terminal type

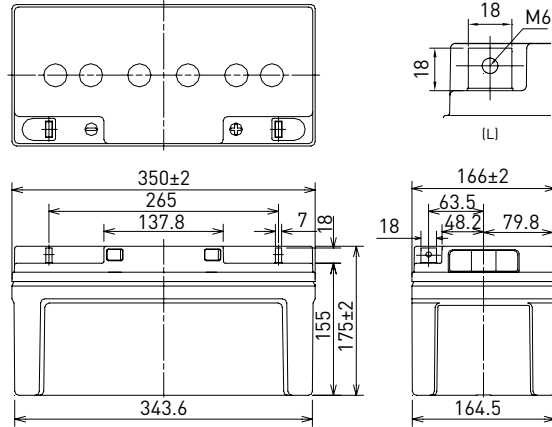

Contents indicated (including the recycle marking, etc.) are subject to change without notice. Battery case resin: standard (UL94 HB)

Specifications		LC-X1265PG*1
Nominal voltage (V)		12
Nominal capacity	20 hours rate (Ah)	65
Dimensions	Length (mm)	166
	Width (mm)	350
	Total height (mm)	175
Approx. mass (kg)		23.5
Terminal type		M6 bolt/nut
Capacity (25°C)	20 hours rate (Ah)	65
	10 hours rate (Ah)	60.0
	3 hours rate (Ah)	49.0
	1 hour rate (Ah)	40.0
Impedance (mΩ)	Fully charged battery (25°C)	7
Temperature dependency of capacity (%) – 20 hours rate	40°C	102
	25°C	100
	0°C	85
	-15°C	65
Remaining capacity (25°C)	After 3 months (%)	91
	After 6 months (%)	82
	After 12 months (%)	64

DURATION OF DISCHARGE VS. DISCHARGE CURRENT

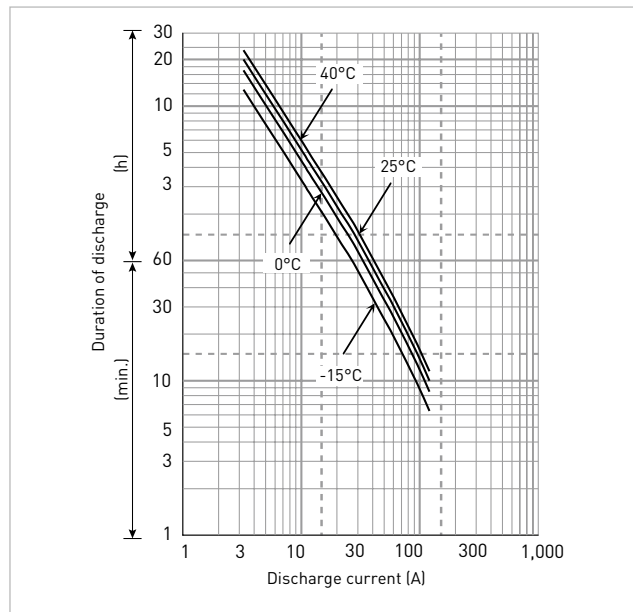

WATT TABLE (25°C)

(Wattage/battery)

Cut-off	5min.	10min.	15min.	20min.	30min.	45min.	1h	1.5h	2h	3h	4h	5h	6h	10h	20h
9.6V	1,884	1,439	1,127	956	742	533	501	321	290	201	158	131	115	70.80	39.00
9.9V	1,851	1,422	1,116	951	734	520	494	313	289	198	157	127	114	70.40	39.00
10.2V	1,735	1,386	1,093	935	725	515	484	307	281	196	156	126	113	70.10	38.90
10.5V	1,554	1,284	1,017	888	709	507	474	300	272	193	154	125	112	69.70	38.80
10.8V	1,374	1,145	949	865	685	499	465	292	259	189	152	122	111	69.00	38.60

AMPERE TABLE (25°C)

(Ampere/battery)

Cut-off	5min.	10min.	15min.	20min.	30min.	45min.	1h	1.5h	2h	3h	4h	5h	6h	10h	20h
9.6V	195	129	98.0	82.4	63.4	45.4	42.2	27.2	24.5	16.9	13.2	11.1	9.60	6.05	3.27
9.9V	193	127	97.0	82.0	62.7	44.3	41.6	26.5	24.4	16.6	13.1	10.8	9.56	6.02	3.27
10.2V	183	124	95.0	80.6	62.0	43.9	40.8	26.0	23.8	16.4	13.0	10.7	9.52	5.99	3.26
10.5V	166	115	88.4	76.6	60.6	43.2	40.0	25.4	22.9	16.2	12.9	10.6	9.41	5.96	3.25
10.8V	150	102	82.5	74.5	58.5	42.5	39.2	24.7	21.9	15.8	12.8	10.3	9.26	5.90	3.23

All mentioned values are average values

*1 This battery is also available with a flame-retardant battery case resin (UL94 V-0): LC-P1265PG.

LC-X1265PG*1

CHARGING METHOD (25°C)

Cycle use	Control voltage: 13.6V - 13.8V Initial current: 9.75A or smaller
------------------	---

CUT-OFF VOLTAGE

Discharge current	3.25A - 13.0A	13.0A - 32.5A	32.5A - 65.0A	65.0A - 130A	130A - 195A
Cut-off voltage	10.5V	10.2V	9.9V	9.3V	8.7V

INFLUENCE OF TEMPERATURE ON TRICKLE LIFE

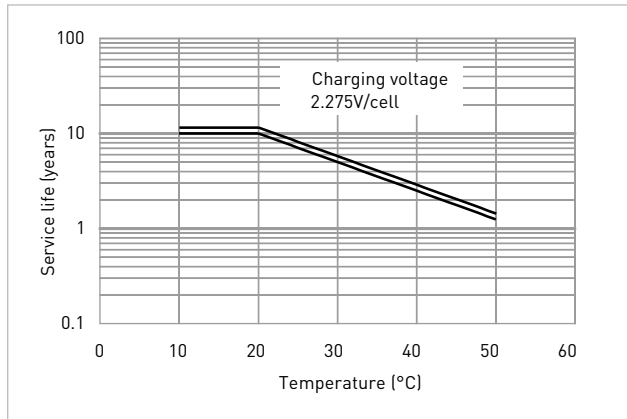

RESIDUAL CAPACITY TEST RESULT

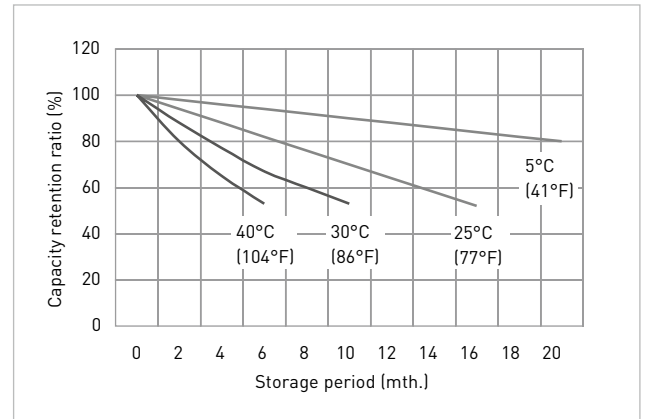

CONSTANT-VOLTAGE CONSTANT-CURRENT CHARGE CHARACTERISTICS FOR TRICKLE USE

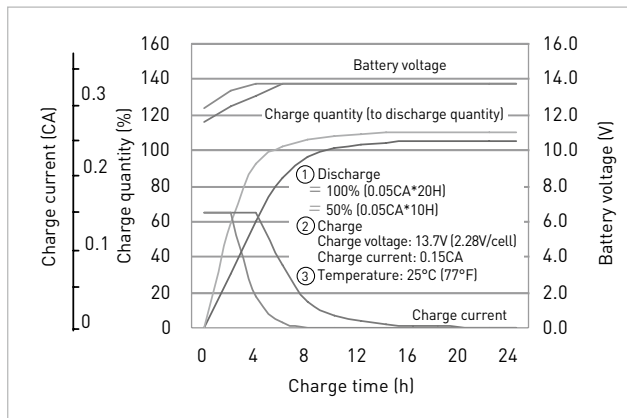

DISCHARGE CAPACITY BY TEMPERATURE AND BY DISCHARGE CURRENT

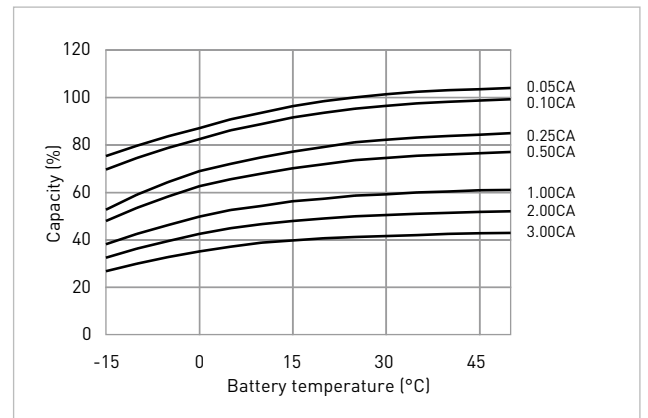

DISCHARGE CHARACTERISTICS

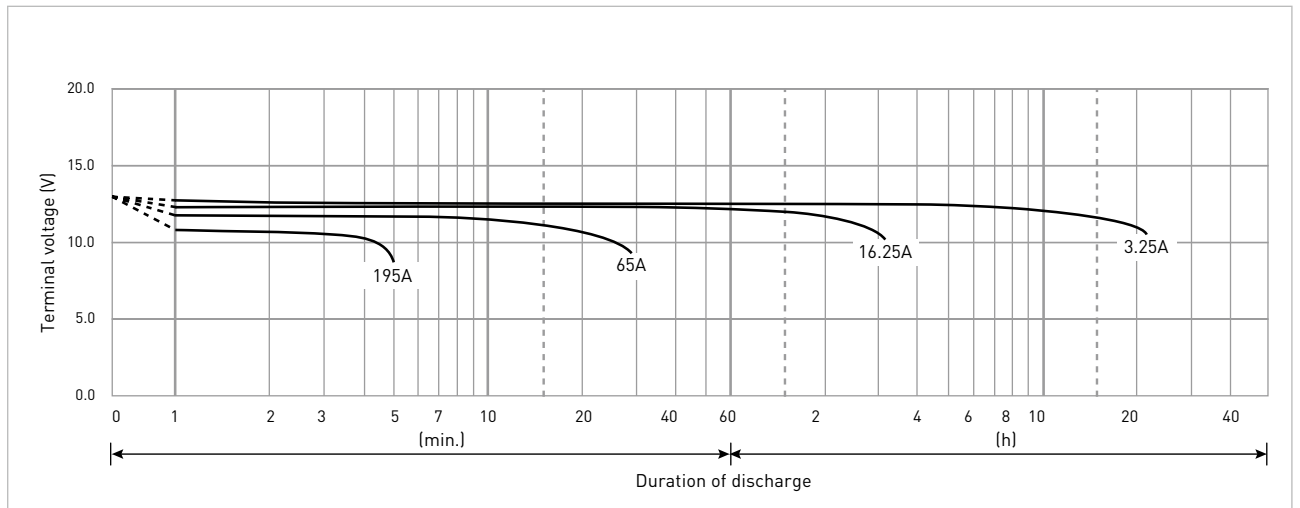

*1 This battery is also available with a flame-retardant battery case resin (UL94 V-0): LC-P1265PG.

LC-P1275P

FOR STANDBY POWER SUPPLIES.
 EXPECTED TRICKLE DESIGN LIFE: 10 – 12 YEARS AT 20°C
 ACCORDING TO EUROBAT.

DIMENSIONS (MM)



Contents indicated (including the recycle marking, etc.) are subject to change without notice. Battery case resin: flame-retardant (UL94 V-0)

Terminal type

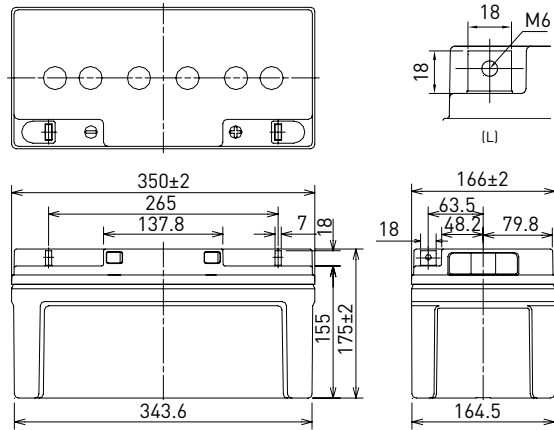

Specifications		LC-P1275P
Nominal voltage (V)		12
Nominal capacity	20 hours rate (Ah)	75
Dimensions	Length (mm)	166
	Width (mm)	350
	Total height (mm)	175
Approx. mass (kg)		21.5
Terminal type		M6 bolt/nut
Capacity (25°C)	20 hours rate (Ah)	75
	10 hours rate (Ah)	70
	3 hours rate (Ah)	53.0
	1 hour rate (Ah)	50.0
Impedance (mΩ)	Fully charged battery (25°C)	7
	Temperature dependency of capacity (%) – 20 hours rate	
	40°C	102
	25°C	100
	0°C	85
	-15°C	65
Remaining capacity (25°C)	After 3 months (%)	91
	After 6 months (%)	82
	After 12 months (%)	64

DURATION OF DISCHARGE VS. DISCHARGE CURRENT

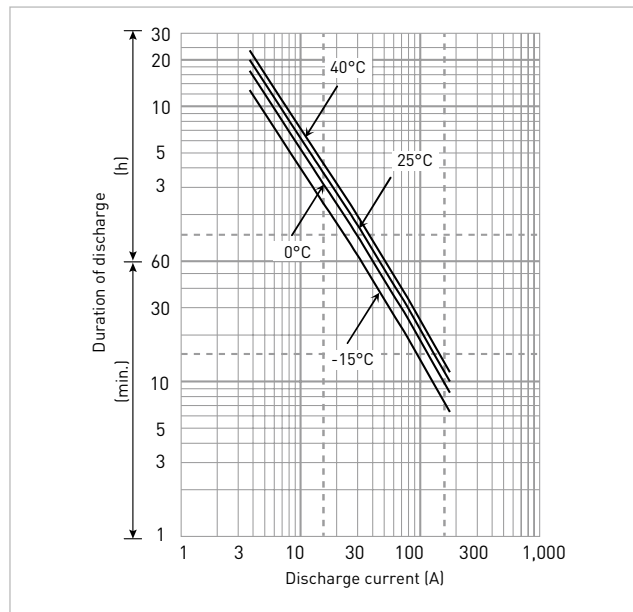

WATT TABLE (25°C)

(Wattage/battery)

Cut-off	5min.	10min.	15min.	20min.	30min.	45min.	1h	1.5h	2h	3h	4h	5h	6h	10h	20h
9.6V	2,273	1,985	1,546	1,313	962	702	555	411	327	220	171	149	125	79.5	45.0
9.9V	2,233	1,950	1,538	1,306	955	683	553	403	325	216	169	147	124	79.1	45.0
10.2V	2,093	1,827	1,531	1,290	940	679	549	400	321	215	168	146	123	78.6	45.0
10.5V	1,875	1,637	1,446	1,230	925	671	546	395	317	210	166	144	122	78.2	45.0
10.8V	1,657	1,447	1,400	1,200	911	580	473	355	301	205	164	143	120	77.8	44.1

AMPERE TABLE (25°C)

(Ampere/battery)

Cut-off	5min.	10min.	15min.	20min.	30min.	45min.	1h	1.5h	2h	3h	4h	5h	6h	10h	20h
9.6V	241	177	134	116	86.9	61.5	51.0	34.8	27.6	18.5	14.3	12.4	10.4	7.14	3.75
9.9V	237	175	132	113	86.3	59.9	50.8	34.1	27.4	18.2	14.2	12.2	10.3	7.11	3.75
10.2V	222	167	130	111	84.9	59.5	50.5	33.8	27.1	18.1	14.0	12.1	10.2	7.07	3.75
10.5V	199	159	126	109	83.6	58.9	50.2	33.4	26.8	17.7	13.9	12.0	10.1	7.04	3.75
10.8V	176	151	122	106	82.3	50.8	43.5	30.1	25.4	17.3	13.7	11.9	10.0	7.00	3.68

All mentioned values are average values

LC-P1275P

CHARGING METHOD (25°C)

Cycle use	Control voltage: 13.6V - 13.8V Initial current: 11.3A or smaller
------------------	---

CUT-OFF VOLTAGE

Discharge current	3.75A - 15.0A	15.0A - 37.5A	37.5A - 75.0A	75.0A - 150A	150A - 225A
Cut-off voltage	10.5V	10.2V	9.9V	9.3V	8.7V

INFLUENCE OF TEMPERATURE ON TRICKLE LIFE

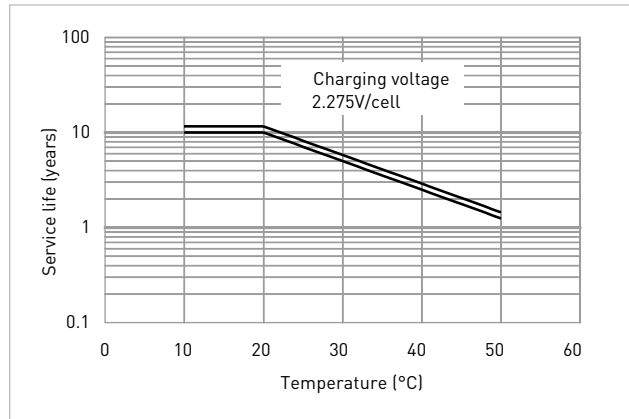

RESIDUAL CAPACITY TEST RESULT

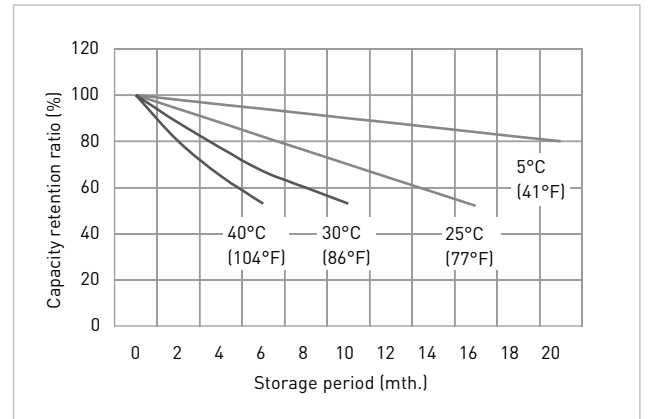

CONSTANT-VOLTAGE CONSTANT-CURRENT CHARGE CHARACTERISTICS FOR TRICKLE USE

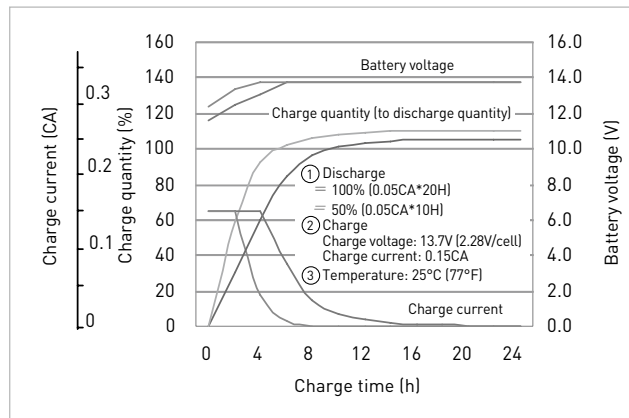

DISCHARGE CAPACITY BY TEMPERATURE AND BY DISCHARGE CURRENT

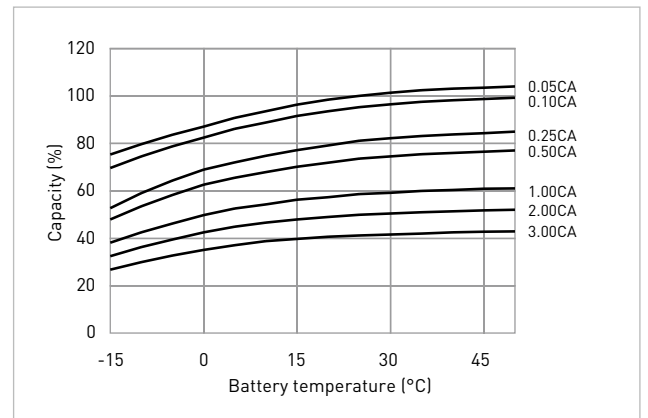

DISCHARGE CHARACTERISTICS

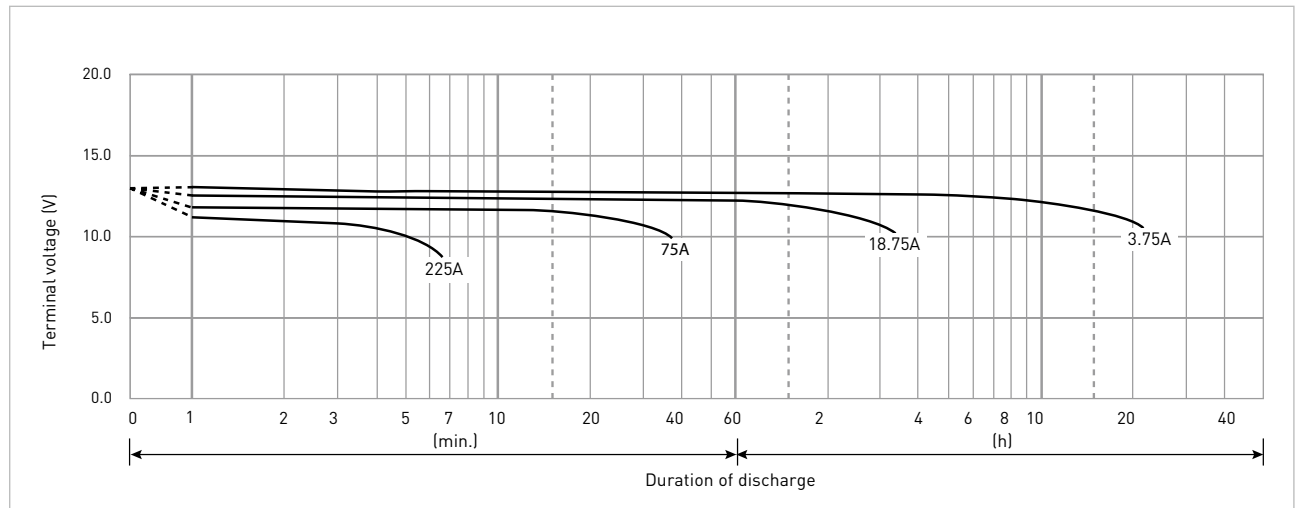

LC-XB12100P*1

FOR STANDBY POWER SUPPLIES.
 EXPECTED TRICKLE DESIGN LIFE: 10 – 12 YEARS AT 20°C
 ACCORDING TO EUROBAT.

DIMENSIONS (MM)



Terminal type

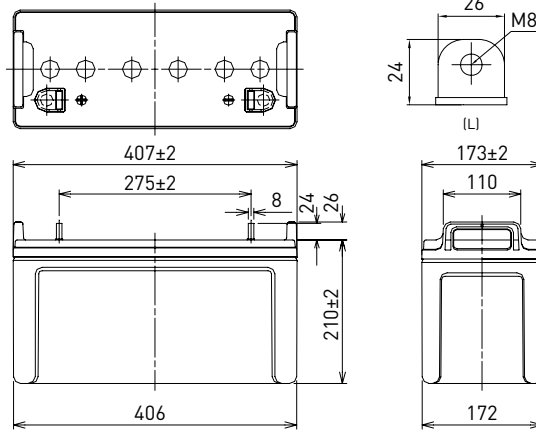

Contents indicated (including the recycle marking, etc.) are subject to change without notice. Battery case resin: standard (UL94 HB)

Specifications		LC-XB12100P*1
Nominal voltage [V]		12
Nominal capacity	20 hours rate (Ah)	100
Dimensions	Length (mm)	173
	Width (mm)	407
	Total height (mm)	236
Approx. mass (kg)		36.5
Terminal type		M8 bolt/nut
Capacity [25°C]	20 hours rate (Ah)	100
	10 hours rate (Ah)	98
	3 hours rate (Ah)	87
	1 hour rate (Ah)	65
Impedance (mΩ)	Fully charged battery (25°C)	5
Temperature dependency of capacity (%) – 20 hours rate	40°C	102
	25°C	100
	0°C	85
	-15°C	65
Remaining capacity [25°C]	After 3 months (%)	91
	After 6 months (%)	82
	After 12 months (%)	64

DURATION OF DISCHARGE VS. DISCHARGE CURRENT

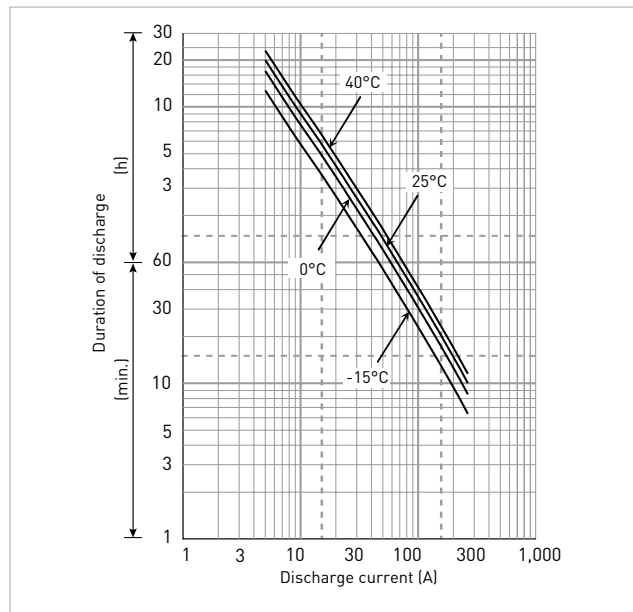

WATT TABLE (25°C)

(Wattage/battery)

Cut-off	5min.	10min.	15min.	20min.	30min.	45min.	1h	1.5h	2h	3h	4h	5h	6h	10h	20h
9.6V	3,504	2,698	2,275	1,776	1,258	904	880	502	411	292	221	188	150	95.0	48.1
9.9V	3,266	2,639	1,973	1,683	1,239	878	795	493	408	287	219	185	149	95.0	48.1
10.2V	2,890	2,534	1,920	1,651	1,229	850	779	489	403	285	217	181	148	94.1	48.1
10.5V	2,498	2,379	1,849	1,601	1,200	738	762	483	398	278	214	180	147	94.1	48.0
10.8V	2,375	2,178	1,756	1,544	1,199	734	758	435	378	272	212	179	144	93.1	47.3

AMPERE TABLE (25°C)

(Ampere/battery)

Cut-off	5min.	10min.	15min.	20min.	30min.	45min.	1h	1.5h	2h	3h	4h	5h	6h	10h	20h
9.6V	365	281	237	185	131	94.2	87.3	52.3	42.8	30.4	23.0	19.5	15.7	9.90	5.01
9.9V	340	275	206	175	129	91.5	78.9	51.3	42.5	29.9	22.8	19.2	15.6	9.90	5.01
10.2V	301	264	200	172	128	88.5	75.5	50.9	42.0	29.7	22.6	18.9	15.5	9.80	5.01
10.5V	260	248	193	167	125	76.9	75.0	50.3	41.5	29.0	22.3	18.8	15.3	9.80	5.00
10.8V	247	227	183	161	125	76.4	74.9	45.3	39.4	28.3	22.0	18.7	15.0	9.70	4.92

All mentioned values are average values

*1 This battery is also available with a flame-retardant battery case resin (UL94 V-0): LC-PB12100P.

LC-XB12100P*1

CHARGING METHOD (25°C)

Cycle use	Control voltage: 13.6V - 13.8V Initial current: 15.0A or smaller
------------------	---

CUT-OFF VOLTAGE

Discharge current	5.00A - 20.0A	20.0A - 50.0A	50.0A - 100A	100A - 200A	200A - 300A
Cut-off voltage	10.5V	10.2V	9.9V	9.3V	8.7V

INFLUENCE OF TEMPERATURE ON TRICKLE LIFE

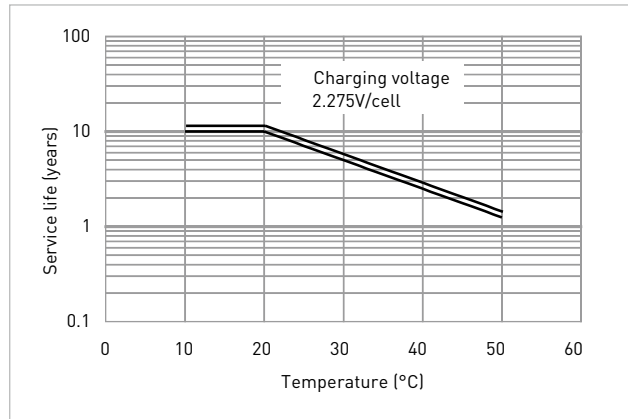

RESIDUAL CAPACITY TEST RESULT

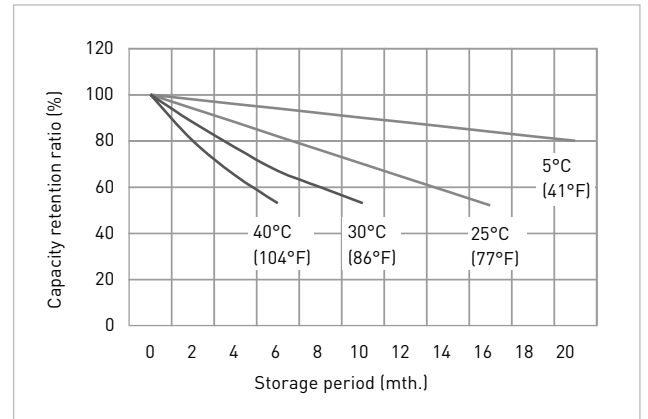

CONSTANT-VOLTAGE CONSTANT-CURRENT CHARGE CHARACTERISTICS FOR TRICKLE USE

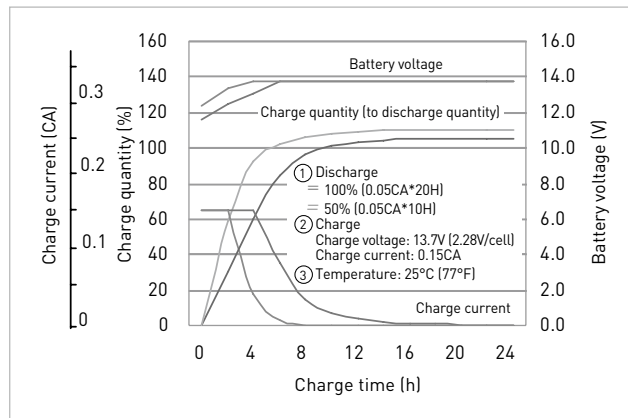

DISCHARGE CAPACITY BY TEMPERATURE AND BY DISCHARGE CURRENT

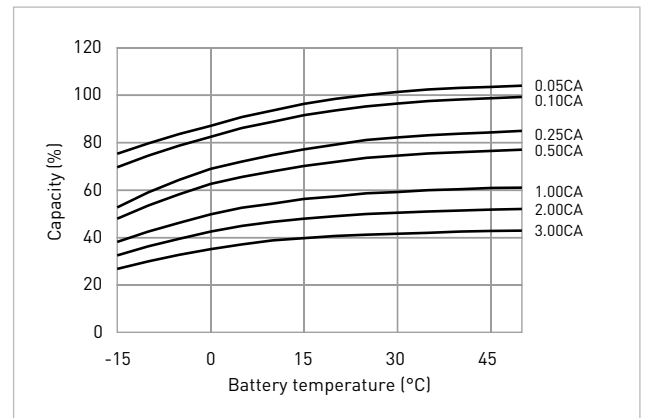

DISCHARGE CHARACTERISTICS

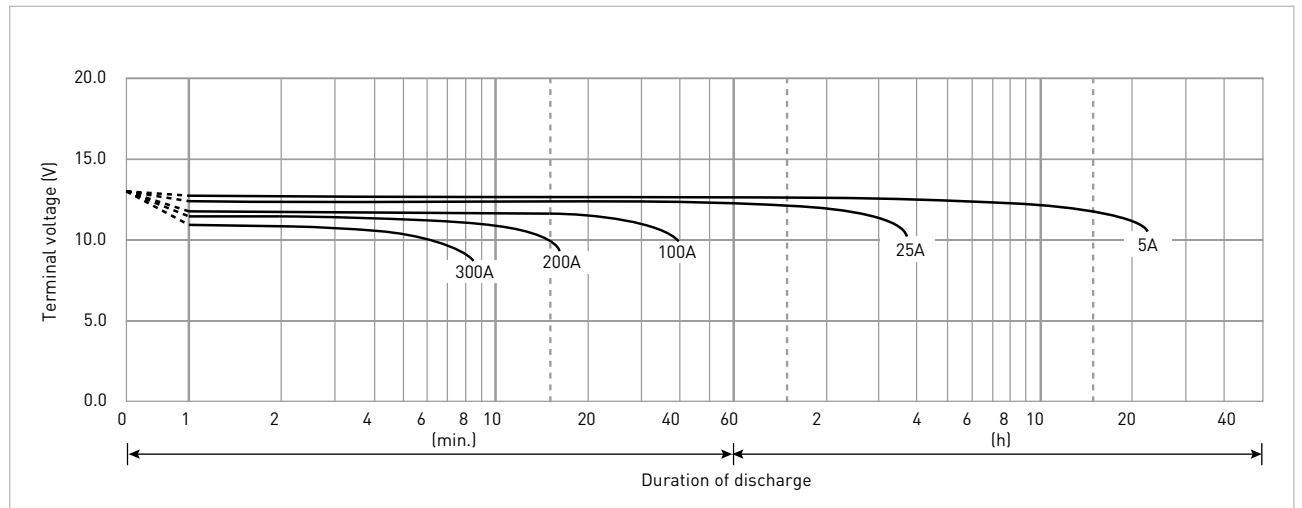

*1 This battery is also available with a flame-retardant battery case resin (UL94 V-0): LC-PB12100P.

LC-P12120P

FOR STANDBY POWER SUPPLIES.
 EXPECTED TRICKLE DESIGN LIFE: 10 – 12 YEARS AT 20°C
 ACCORDING TO EUROBAT.

DIMENSIONS (MM)



Contents indicated (including the recycle marking, etc.) are subject to change without notice. Battery case resin: flame-retardant (UL94 V-0)

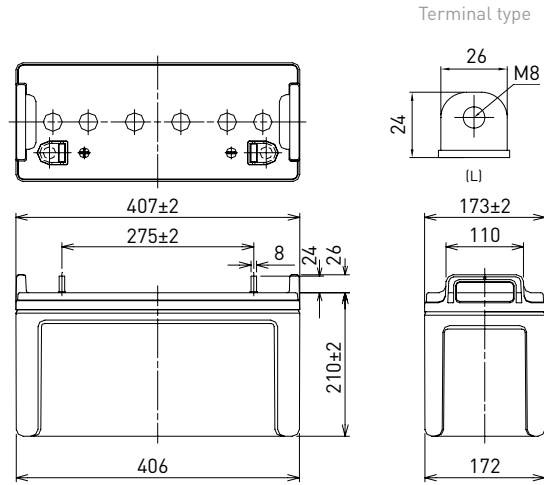

Specifications		LC-P12120P
Nominal voltage (V)		12
Nominal capacity	20 hours rate (Ah)	120
Dimensions	Length (mm)	173
	Width (mm)	407
	Total height (mm)	236
Approx. mass (kg)		34.5
Terminal type		M8 bolt/nut
Capacity (25°C)	20 hours rate (Ah)	120
	10 hours rate (Ah)	110
	3 hours rate (Ah)	93
	1 hour rate (Ah)	85
Impedance (mΩ)	Fully charged battery (25°C)	4.5
	Temperature dependency of capacity (%) – 20 hours rate	
	40°C	102
	25°C	100
	0°C	85
	-15°C	65
Remaining capacity (25°C)	After 3 months (%)	91
	After 6 months (%)	82
	After 12 months (%)	64

DURATION OF DISCHARGE VS. DISCHARGE CURRENT

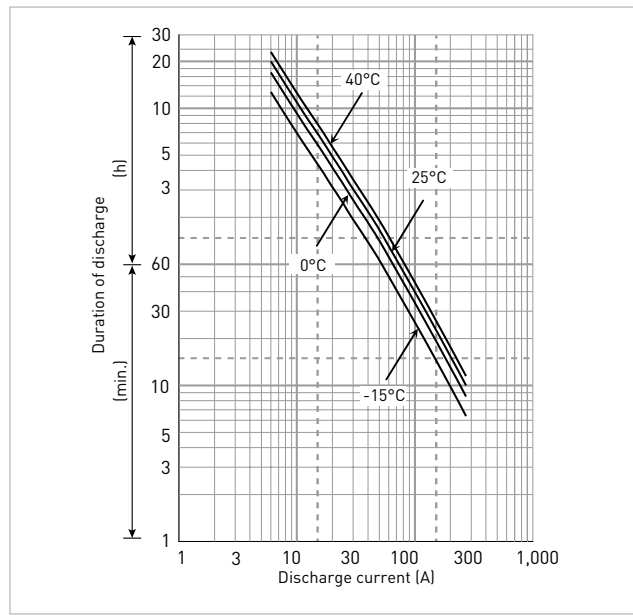

WATT TABLE (25°C)

(Wattage/battery)

Cut-off	5min.	10min.	15min.	20min.	30min.	45min.	1h	1.5h	2h	3h	4h	5h	6h	10h	20h
9.6V	3,603	2,883	2,296	2,036	1,409	1,095	835	663	499	326	261	197	179	104	60.2
9.9V	3,537	2,849	2,285	2,024	1,370	1,062	820	662	486	322	255	191	177	103	60.1
10.2V	3,309	2,776	2,273	2,001	1,322	1,040	805	642	479	315	249	185	168	102	60.0
10.5V	3,020	2,572	2,148	1,907	1,316	1,025	779	629	470	310	246	184	166	101	60.0
10.8V	2,916	2,294	2,079	1,861	1,281	980	756	559	458	306	240	180	163	99.8	59.9

AMPERE TABLE (25°C)

(Ampere/battery)

Cut-off	5min.	10min.	15min.	20min.	30min.	45min.	1h	1.5h	2h	3h	4h	5h	6h	10h	20h
9.6V	361	271	211	181	139	105	86.9	59.3	47.9	32.1	23.7	20.6	17.4	11.1	6.00
9.9V	357	267	210	180	138	102	86.6	58.1	47.5	31.5	23.4	20.4	17.3	11.1	6.00
10.2V	348	261	209	178	136	97.0	85.9	57.7	46.9	31.2	23.2	20.0	17.2	11.0	6.00
10.5V	322	241	198	170	134	92.0	85.4	56.9	46.3	31.0	23.0	19.9	17.1	11.0	6.00
10.8V	282	211	192	165	132	86.9	74.0	51.2	44.0	29.9	22.7	19.8	16.7	10.9	5.88

All mentioned values are average values

LC-P12120P

CHARGING METHOD (25°C)

Cycle use	Control voltage: 13.6V - 13.8V Initial current: 18.0A or smaller
------------------	---

CUT-OFF VOLTAGE

Discharge current	6.00A - 24.0A	24.0A - 60.0A	60.0A - 120A	120A - 240A	240A - 300A
Cut-off voltage	10.5V	10.2V	9.9V	9.3V	8.7V

INFLUENCE OF TEMPERATURE ON TRICKLE LIFE

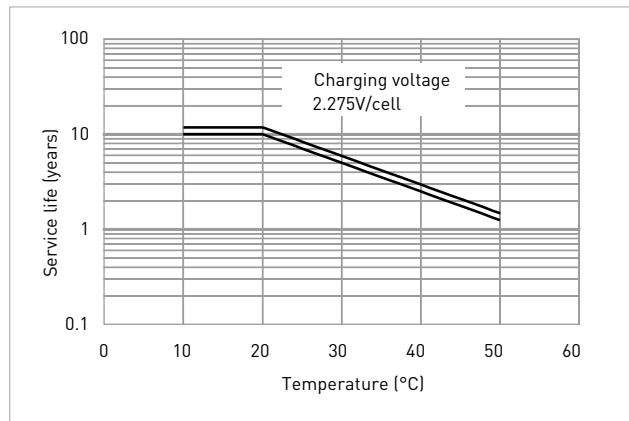

RESIDUAL CAPACITY TEST RESULT

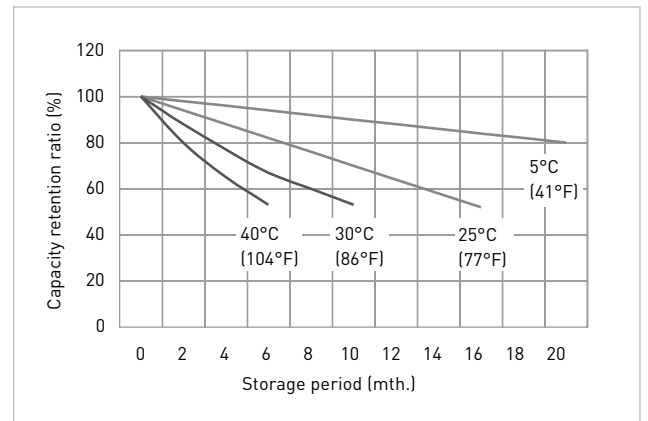

CONSTANT-VOLTAGE CONSTANT-CURRENT CHARGE CHARACTERISTICS FOR TRICKLE USE

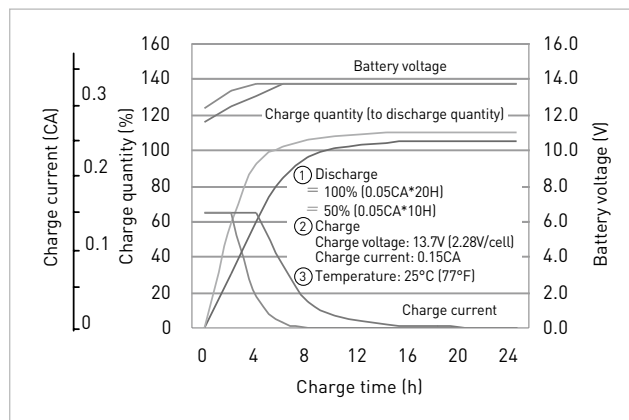

DISCHARGE CAPACITY BY TEMPERATURE AND BY DISCHARGE CURRENT

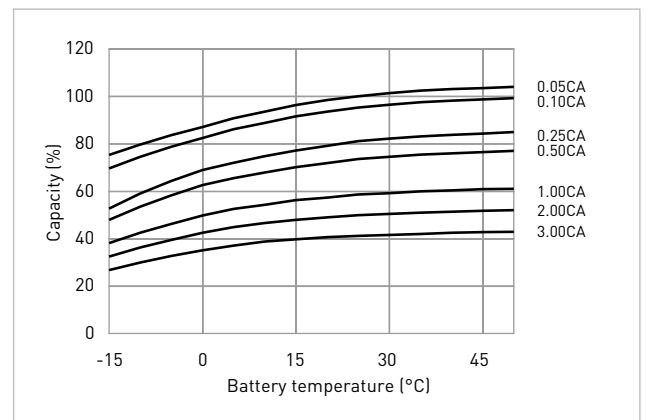

DISCHARGE CHARACTERISTICS

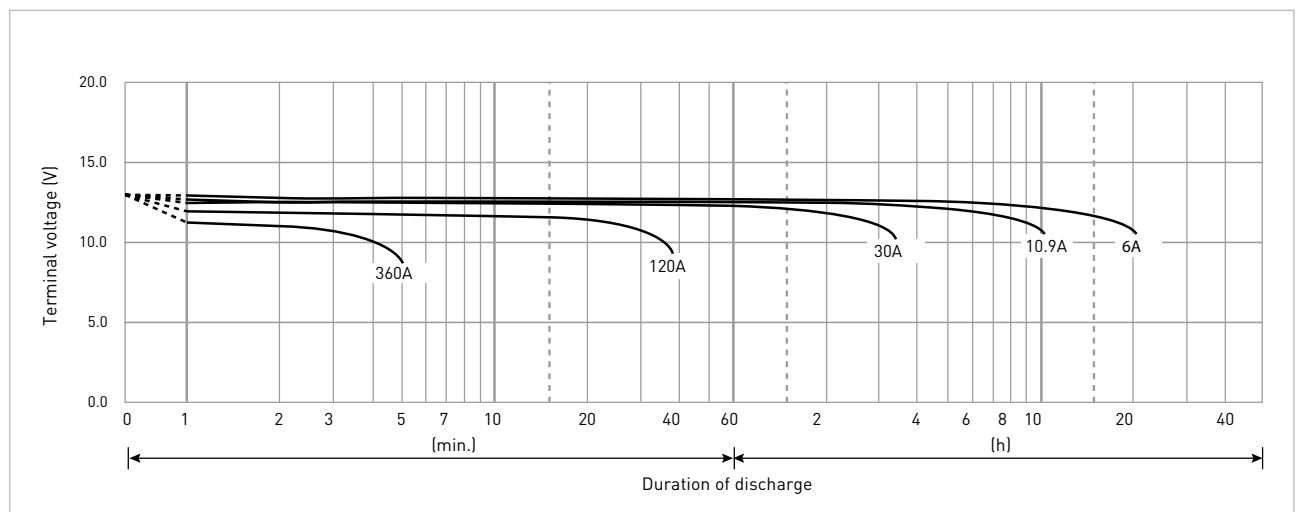

LC-P12150BP*1

FOR STANDBY POWER SUPPLIES.
 EXPECTED TRICKLE DESIGN LIFE: 10 – 12 YEARS AT 20°C
 ACCORDING TO EUROBAT.

DIMENSIONS (MM)

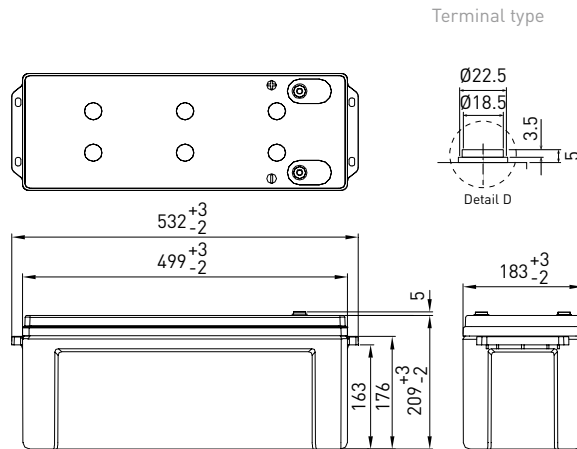

Contents indicated (including the recycle marking, etc.) are subject to change without notice. Battery case resin: flame-retardant (UL94 V-0)

Specifications		LC-P12150BP*1
Nominal voltage (V)		12
Nominal capacity 20 hours rate (Ah)		150
Dimensions	Length (mm)	183
	Width (mm)	532
	Total height (mm)	214
Approx. mass (kg)		43.0
Terminal type		M8x20 insert
Capacity (25°C)	20 hours rate (Ah)	150
	10 hours rate (Ah)	137
	3 hours rate (Ah)	119
	1 hour rate (Ah)	88
Impedance (mΩ)	Fully charged battery (25°C)	3.5
	Temperature dependency of capacity (%) – 20 hours rate	
	40°C	102
	25°C	100
	0°C	85
	-15°C	65
Remaining capacity (25°C)	After 3 months (%)	91
	After 6 months (%)	82
	After 12 months (%)	64

DURATION OF DISCHARGE VS. DISCHARGE CURRENT

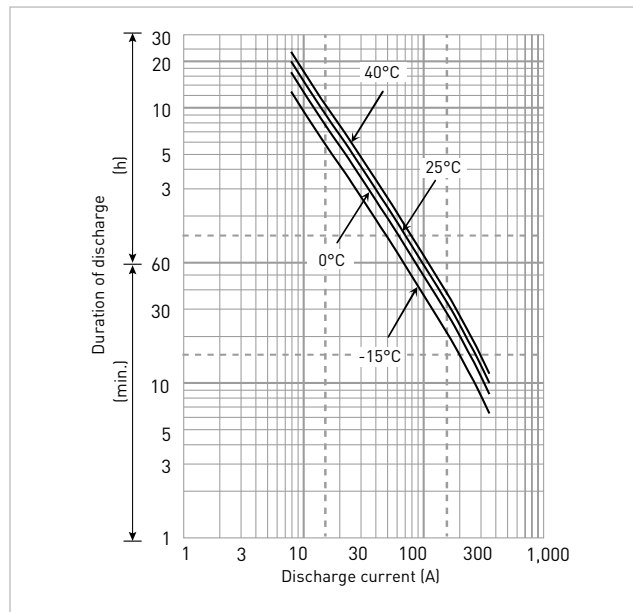

WATT TABLE (25°C)

(Wattage/battery)

Cut-off	5min.	10min.	15min.	20min.	30min.	45min.	1h	1.5h	2h	3h	4h	5h	6h	10h	20h
9.6V	5,040	3,780	3,000	2,390	1,774	1,310	1,046	791	608	444	348	284	242	164	91.2
9.9V	4,925	3,689	2,923	2,334	1,727	1,276	1,013	763	596	437	342	281	240	163	91.2
10.2V	4,340	3,405	2,833	2,261	1,672	1,238	976	724	592	433	339	278	237	163	91.1
10.5V	4,020	3,216	2,751	2,197	1,641	1,208	947	695	585	428	334	274	235	161	90.3
10.8V	3,850	2,839	2,661	2,149	1,601	1,163	910	659	576	420	328	268	232	160	90.3

AMPERE TABLE (25°C)

(Ampere/battery)

Cut-off	5min.	10min.	15min.	20min.	30min.	45min.	1h	1.5h	2h	3h	4h	5h	6h	10h	20h
9.6V	490	350	266	217	164	120	97.2	70.0	59.0	42.1	32.9	27.3	23.0	14.0	7.58
9.9V	479	342	259	212	159	117	94.1	67.5	58.0	41.3	32.3	26.7	22.6	13.9	7.58
10.2V	422	315	251	206	154	114	90.7	64.1	56.9	40.4	31.5	26.0	22.2	13.8	7.50
10.5V	381	298	244	200	151	111	88.0	61.5	55.8	39.8	31.0	25.7	22.0	13.7	7.50
10.8V	334	263	236	195	148	107	84.6	58.3	54.4	38.8	30.3	25.2	21.6	13.5	7.49

All mentioned values are average values

*1 This battery is equipped with insert terminals.

LC-P12150BP*1

CHARGING METHOD (25°C)

Cycle use	Control voltage: 13.6V - 13.8V Initial current: 22.5A or smaller
------------------	---

CUT-OFF VOLTAGE

Discharge current	7.50A - 30.0A	30.0A - 75.0A	75.0A - 150A	150A - 300A	300A - 450A
Cut-off voltage	10.5V	10.2V	9.9V	9.3V	8.7V

INFLUENCE OF TEMPERATURE ON TRICKLE LIFE

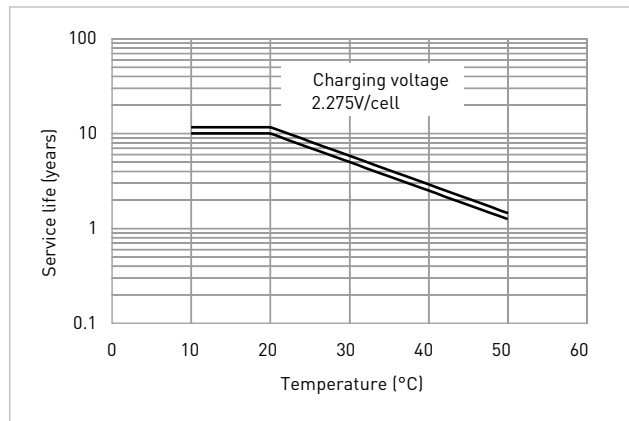

RESIDUAL CAPACITY TEST RESULT

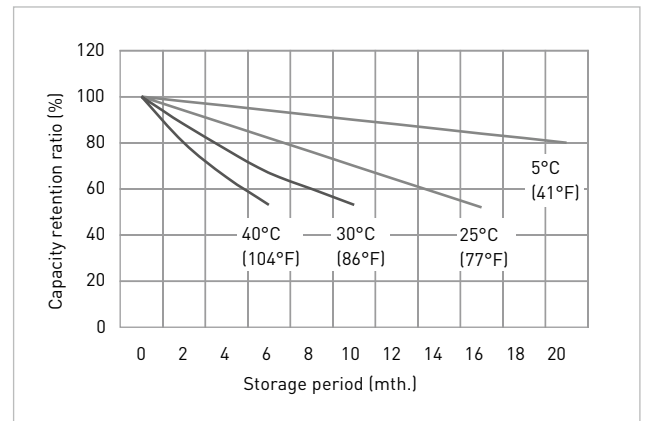

CONSTANT-VOLTAGE CONSTANT-CURRENT CHARGE CHARACTERISTICS FOR TRICKLE USE

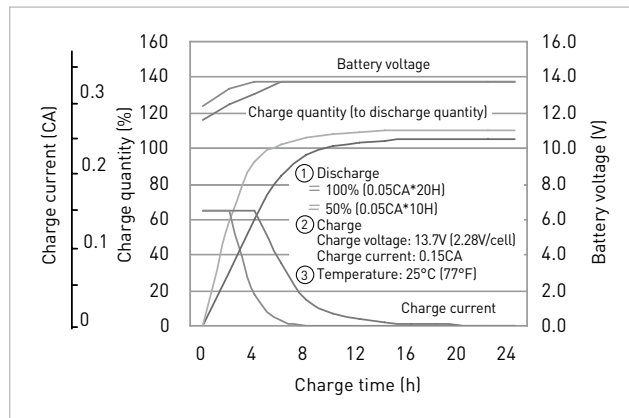

DISCHARGE CAPACITY BY TEMPERATURE AND BY DISCHARGE CURRENT

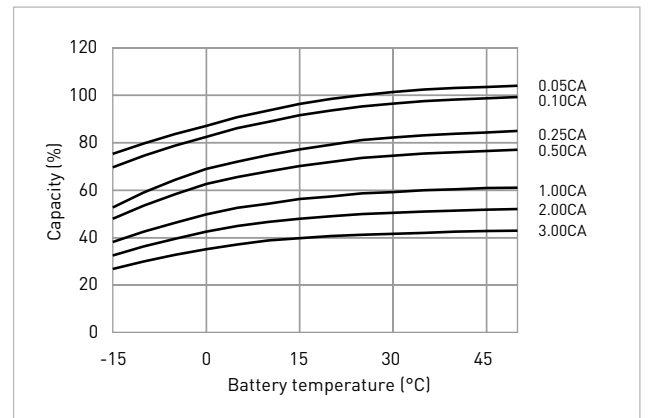

DISCHARGE CHARACTERISTICS

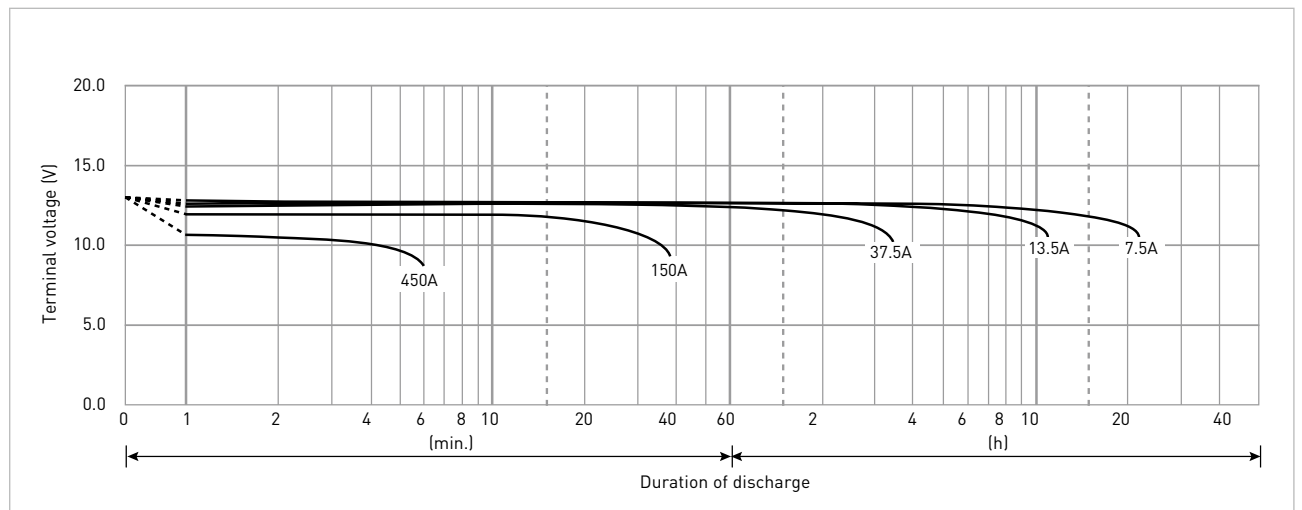

*1 This battery is equipped with insert terminals.

The data in this document are for descriptive purposes only and are not intended to make or imply any guarantee or warranty. Regarding handling and safety please consult our VRLA technical handbook chapter 'Precautions for handling VRLA batteries'.

LC-P12200BP*1

FOR STANDBY POWER SUPPLIES.
 EXPECTED TRICKLE DESIGN LIFE: 10 – 12 YEARS AT 20°C
 ACCORDING TO EUROBAT.

DIMENSIONS (MM)

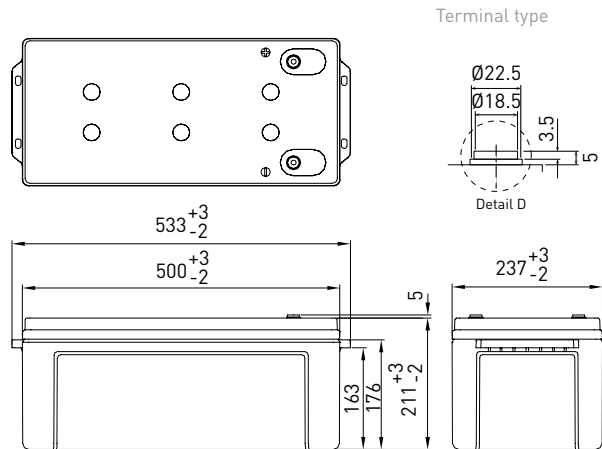

Contents indicated (including the recycle marking, etc.) are subject to change without notice. Battery case resin: flame-retardant (UL94 V-0)

Specifications		LC-P12200BP*1
Nominal voltage [V]		12
Nominal capacity	20 hours rate (Ah)	200
Dimensions	Length (mm)	237
	Width (mm)	533
	Total height (mm)	216
Approx. mass (kg)		57.0
Terminal type		M8x20 insert
Capacity [25°C]	20 hours rate (Ah)	200
	10 hours rate (Ah)	187
	3 hours rate (Ah)	169
	1 hour rate (Ah)	118
Impedance (mΩ)	Fully charged battery (25°C)	2.5
	Temperature dependency of capacity (%) – 20 hours rate	
	40°C	102
	25°C	100
	0°C	85
	-15°C	65
Remaining capacity [25°C]	After 3 months (%)	91
	After 6 months (%)	82
	After 12 months (%)	64

DURATION OF DISCHARGE VS. DISCHARGE CURRENT

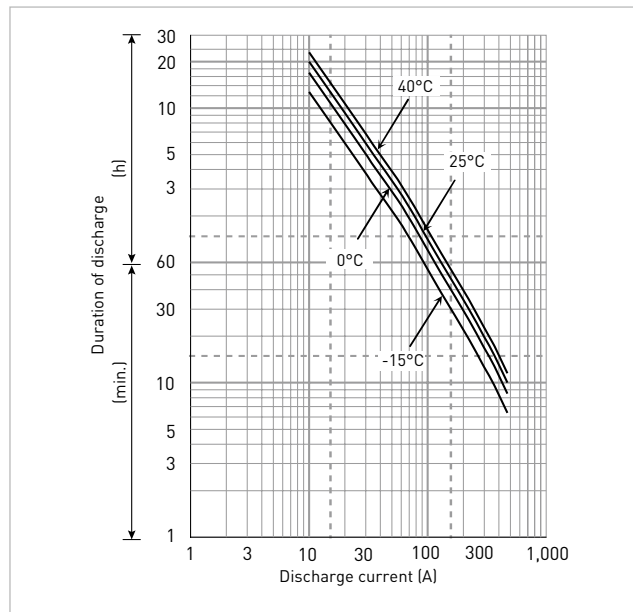

WATT TABLE (25°C)

(Wattage/battery)

Cut-off	5min.	10min.	15min.	20min.	30min.	45min.	1h	1.5h	2h	3h	4h	5h	6h	10h	20h
9.6V	6,577	5,182	4,285	3,512	2,651	1,863	1,505	1,106	917	668	524	432	369	235	129
9.9V	6,427	5,052	4,264	3,491	2,577	1,807	1,478	1,105	893	660	512	420	363	234	128
10.2V	5,643	4,649	3,966	3,175	2,352	1,674	1,336	965	837	618	483	401	333	222	128
10.5V	5,092	4,390	3,851	3,085	2,308	1,634	1,296	925	821	608	475	396	331	221	128
10.8V	4,462	3,876	3,725	3,017	2,253	1,573	1,246	877	800	592	464	388	325	220	128

AMPERE TABLE (25°C)

(Ampere/battery)

Cut-off	5min.	10min.	15min.	20min.	30min.	45min.	1h	1.5h	2h	3h	4h	5h	6h	10h	20h
9.6V	655	471	366	297	222	163	130	95.7	86.0	59.6	45.6	37.0	30.2	19.0	10.1
9.9V	640	460	357	290	217	159	126	92.3	84.6	58.5	44.8	36.1	29.8	18.9	10.1
10.2V	564	425	346	281	210	154	121	87.7	83.0	57.3	43.7	35.3	29.2	18.8	10.0
10.5V	509	401	336	273	206	150	118	84.1	81.5	56.4	43.0	34.9	29.0	18.7	10.0
10.8V	446	354	325	267	201	145	113	79.7	79.4	54.9	42.0	34.1	28.4	18.5	9.99

All mentioned values are average values

*1 This battery is equipped with insert terminals.

LC-P12200BP*1

CHARGING METHOD (25°C)

Cycle use	Control voltage: 13.6V - 13.8V Initial current: 30.0A or smaller
------------------	---

CUT-OFF VOLTAGE

Discharge current	10.0A - 40.0A	40.0A - 100A	100A - 200A	200A - 400A	400A - 600A
Cut-off voltage	10.5V	10.2V	9.9V	9.3V	8.7V

INFLUENCE OF TEMPERATURE ON TRICKLE LIFE

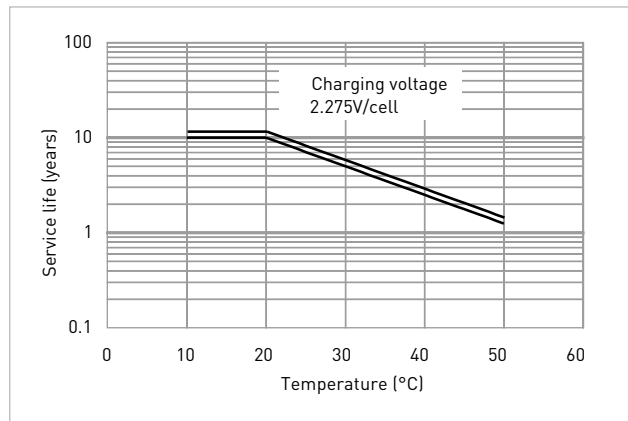

RESIDUAL CAPACITY TEST RESULT

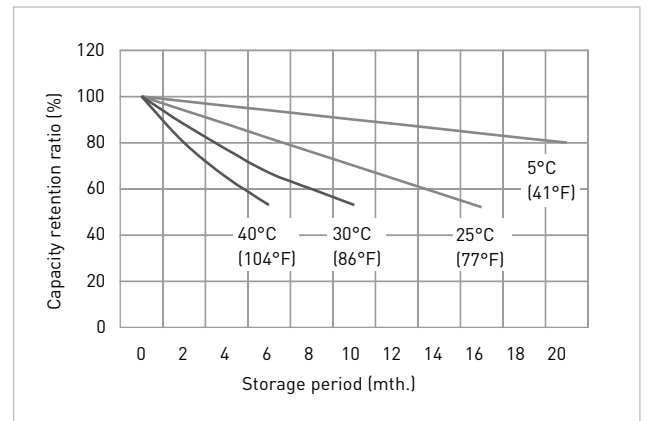

CONSTANT-VOLTAGE CONSTANT-CURRENT CHARGE CHARACTERISTICS FOR TRICKLE USE

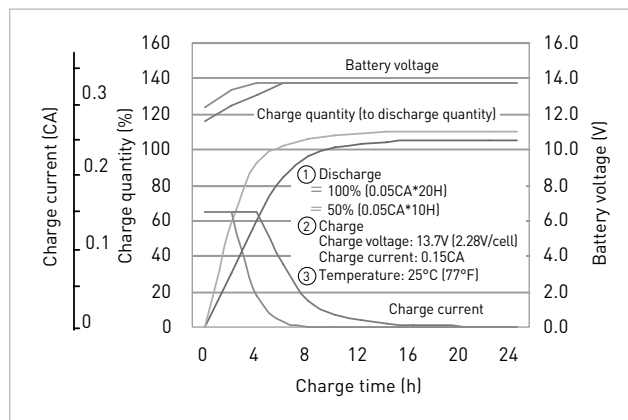

DISCHARGE CAPACITY BY TEMPERATURE AND BY DISCHARGE CURRENT

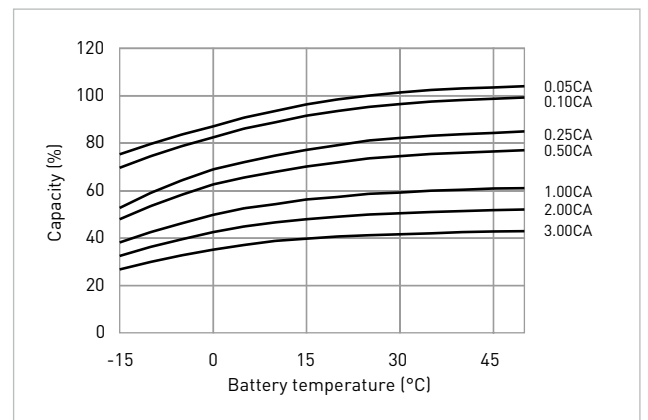

DISCHARGE CHARACTERISTICS

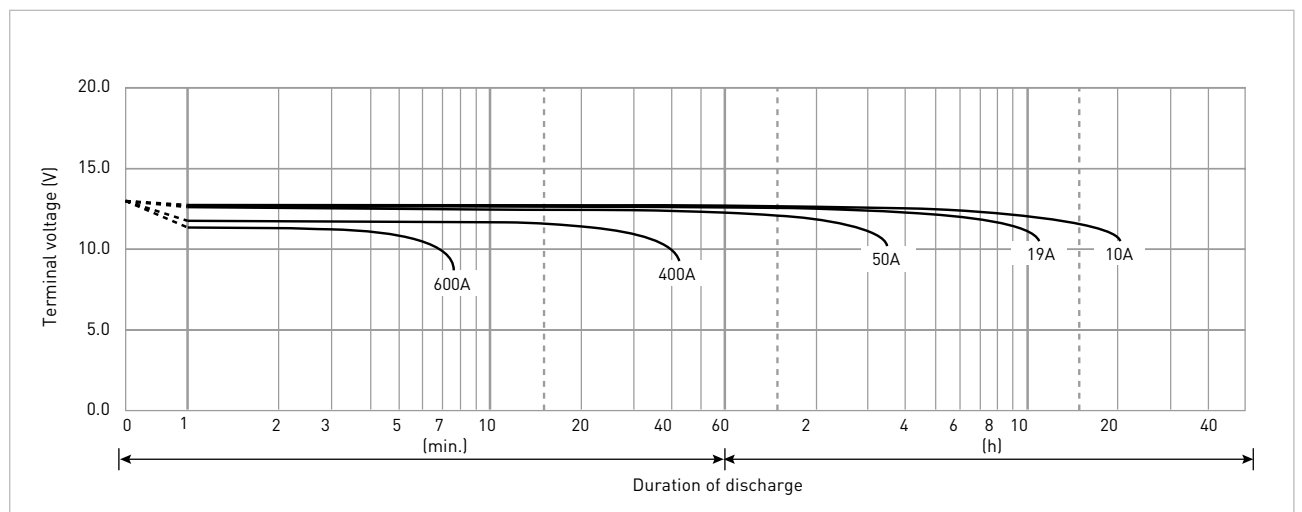

*1 This battery is equipped with insert terminals.

The data in this document are for descriptive purposes only and are not intended to make or imply any guarantee or warranty. Regarding handling and safety please consult our VRLA technical handbook chapter 'Precautions for handling VRLA batteries'.

LC-QA06210TP

FOR STANDBY POWER SUPPLIES.
EXPECTED TRICKLE DESIGN LIFE: 15 YEARS AT 20°C.

DIMENSIONS (MM)

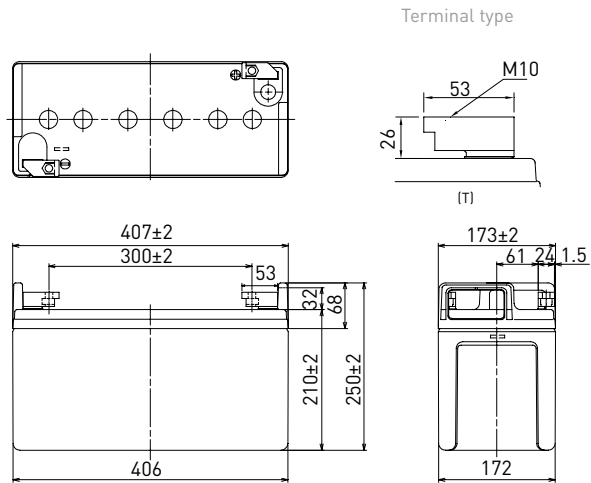

Contents indicated (including the recycle marking, etc.) are subject to change without notice. Battery case resin: flame-retardant (UL94 V-0)

Specifications		LC-QA06210TP
Nominal voltage (V)		6
Nominal capacity	20 hours rate (Ah)	210
Dimensions	Length (mm)	173
	Width (mm)	407
	Total height (mm)	250
Approx. mass (kg)		36.5
Terminal type		M10 T-shape
Capacity (25°C)	20 hours rate (Ah)	212
	10 hours rate (Ah)	202
	3 hours rate (Ah)	176
	1 hour rate (Ah)	135
Impedance (mΩ)	Fully charged battery (25°C)	1.5
Temperature dependency of capacity (%) – 20 hours rate	40°C	102
	25°C	100
	0°C	85
	-15°C	65
Remaining capacity (25°C)	After 3 months (%)	91
	After 6 months (%)	82
	After 12 months (%)	64

DURATION OF DISCHARGE VS. DISCHARGE CURRENT

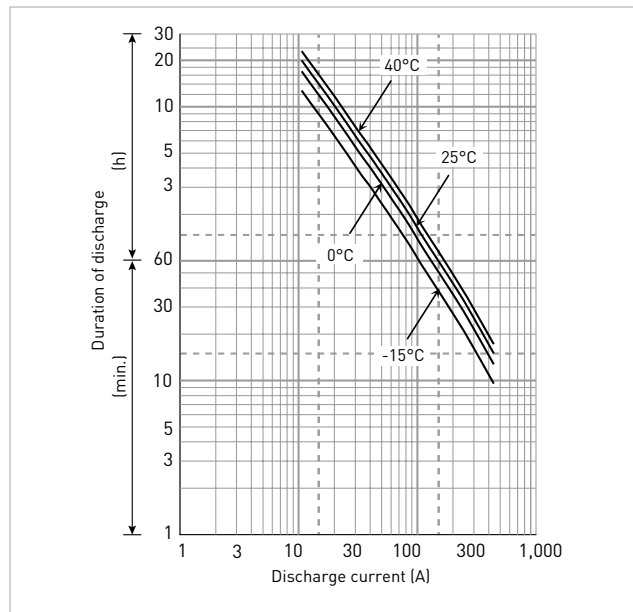

WATT TABLE (25°C)

(Wattage/battery)

Cut-off	15min.	20min.	30min.	45min.	1h	1.5h	2h	3h	4h	5h	6h	10h	20h
4.80V	2,220	1,816	1,349	986	769	561	467	343	274	222	191	121	61.8
4.95V	2,167	1,773	1,317	964	749	546	454	337	268	215	185	117	61.3
5.10V	2,089	1,709	1,274	954	729	531	448	331	262	209	180	115	61.1
5.25V	2,063	1,696	1,264	939	708	517	439	325	260	206	179	114	60.6
5.40V	1,966	1,687	1,223	905	698	509	428	319	254	203	177	113	59.8

AMPERE TABLE (25°C)

(Ampere/battery)

Cut-off	15min.	20min.	30min.	45min.	1h	1.5h	2h	3h	4h	5h	6h	10h	20h
4.80V	440	364	274	200	153	107	88.1	61.5	47.6	39.5	32.3	20.5	10.6
4.95V	438	362	272	195	144	105	87.5	60.4	47.1	38.8	32.2	20.4	10.6
5.10V	436	358	268	193	140	104	86.4	60.0	46.7	38.2	32.1	20.3	10.6
5.25V	412	341	263	191	135	103	85.4	58.7	46.2	38.0	32.0	20.2	10.6
5.40V	398	333	259	165	131	92.3	81.1	57.3	45.6	37.8	31.0	20.1	10.4

All mentioned values are average values

LC-QA06210TP

CHARGING METHOD (25°C)

Cycle use	Control voltage: 6.80V - 6.90V Initial current: 31.5A or smaller
------------------	---

CUT-OFF VOLTAGE

Discharge current	10.5A - 42.0A	42.0A - 105A	105A - 210A	210A - 420A	420A - 630A
Cut-off voltage	5.25V	5.10V	4.95V	4.65V	4.35V

INFLUENCE OF TEMPERATURE ON TRICKLE LIFE

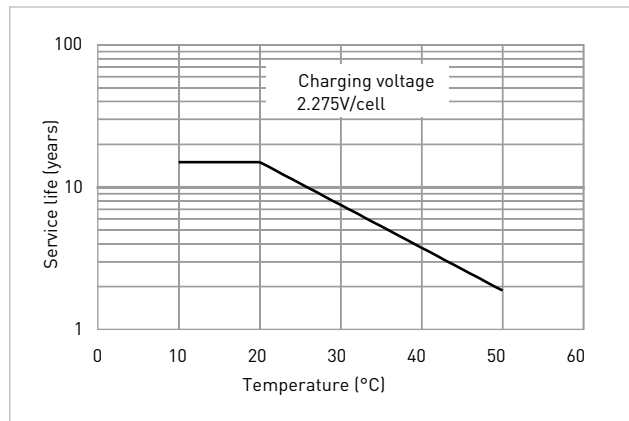

RESIDUAL CAPACITY TEST RESULT

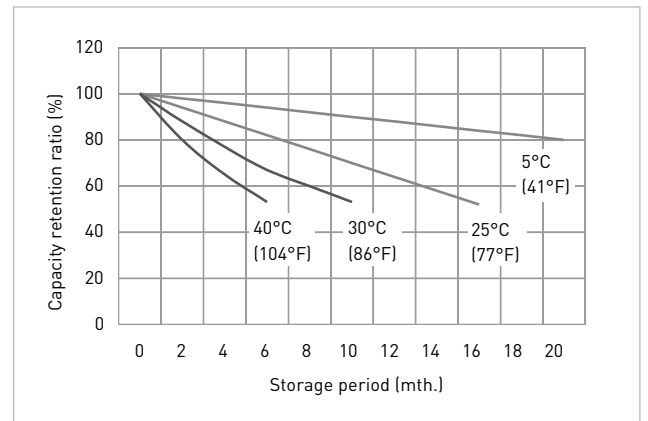

CONSTANT-VOLTAGE CONSTANT-CURRENT CHARGE CHARACTERISTICS FOR TRICKLE USE

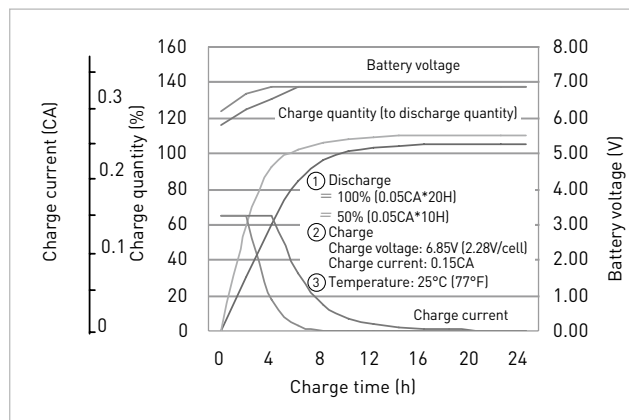

DISCHARGE CAPACITY BY TEMPERATURE AND BY DISCHARGE CURRENT

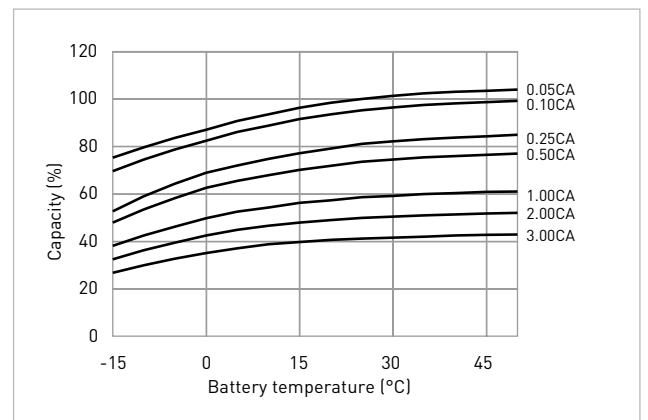

DISCHARGE CHARACTERISTICS

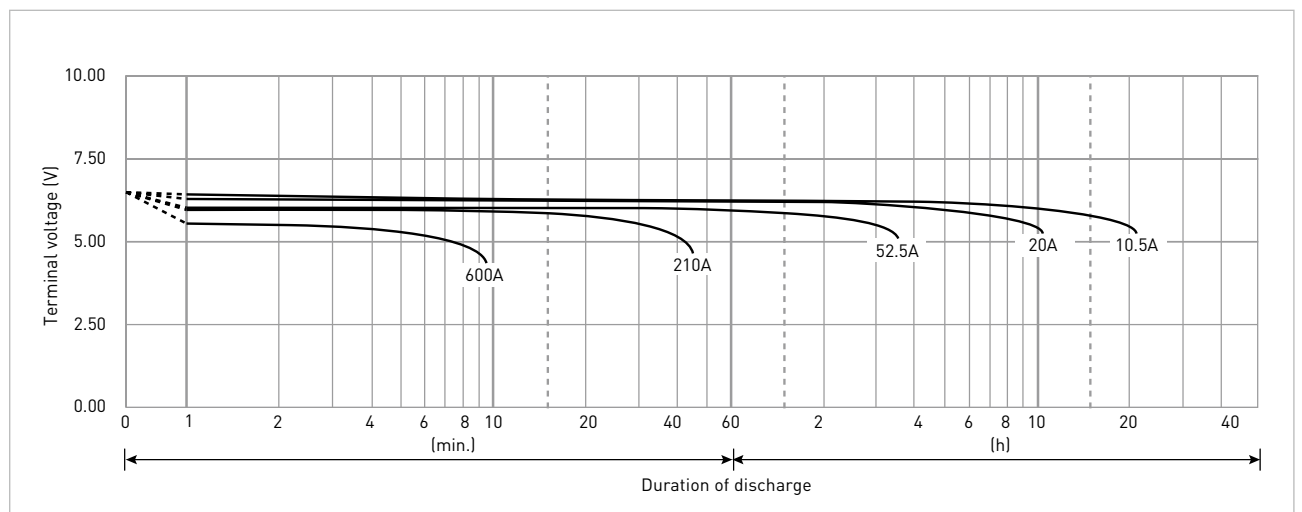

LC-QA1224P/AP

FOR STANDBY POWER SUPPLIES.
EXPECTED TRICKLE DESIGN LIFE: 15 YEARS AT 20°C.

DIMENSIONS (MM)



Terminal type (option)

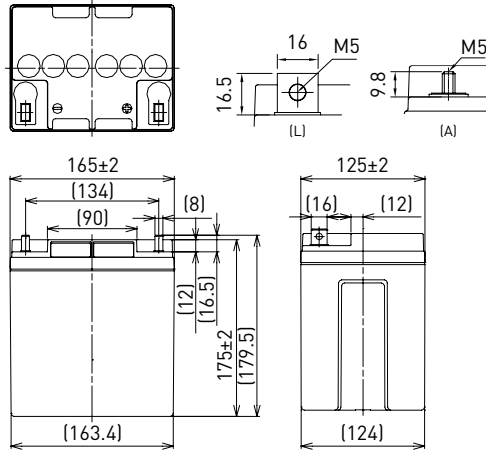

Contents indicated (including the recycle marking, etc.) are subject to change without notice. Battery case resin: flame-retardant (UL94 V-0)

Specifications		LC-QA1224P/AP
Nominal voltage (V)		12
Nominal capacity	20 hours rate (Ah)	24.0
Dimensions	Length (mm)	125
	Width (mm)	165
	Total height (mm)	175
Approx. mass (kg)		9.9
Terminal type		M5 bolt/nut & threaded post
Capacity (25°C)	20 hours rate (Ah)	27.0
	10 hours rate (Ah)	25.0
	3 hours rate (Ah)	20.0
	1 hour rate (Ah)	16.0
Impedance (mΩ) Fully charged battery (25°C)		8
Temperature dependency of capacity (%) - 20 hours rate	40°C	102
	25°C	100
	0°C	85
	-15°C	65
Remaining capacity (25°C)	After 3 months (%)	91
	After 6 months (%)	82
	After 12 months (%)	64

DURATION OF DISCHARGE VS. DISCHARGE CURRENT

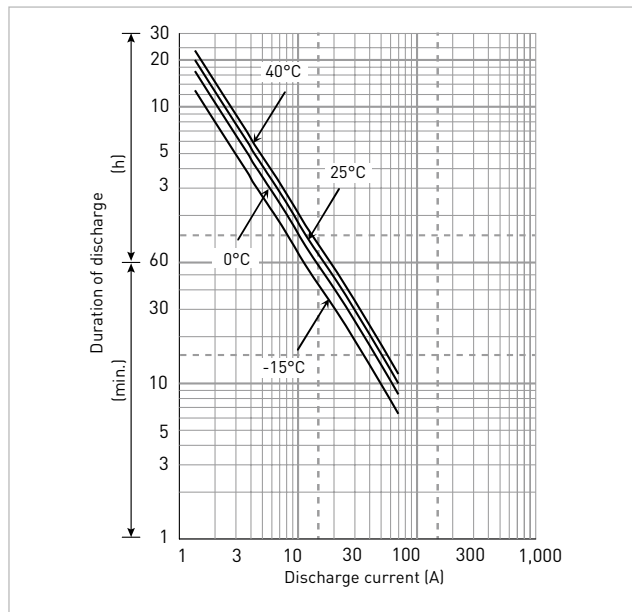

WATT TABLE (25°C)

(Wattage/battery)

Cut-off	10min.	15min.	20min.	30min.	45min.	1h	1.5h	2h	3h	4h	5h	6h	10h	20h
9.6V	773	605	521	401	280	215	167	113	79.9	65.8	51.8	46.8	27.0	13.5
9.9V	760	600	512	396	274	210	163	112	79.7	65.3	50.9	46.0	26.8	13.5
10.2V	746	591	503	390	268	205	159	111	79.3	64.7	50.1	45.3	26.4	13.4
10.5V	724	575	479	372	261	200	155	107	78.2	64.0	49.7	44.8	26.1	13.3
10.8V	701	558	456	344	256	196	152	104	77.1	63.2	49.5	44.3	25.9	13.3

AMPERE TABLE (25°C)

(Ampere/battery)

Cut-off	10min.	15min.	20min.	30min.	45min.	1h	1.5h	2h	3h	4h	5h	6h	10h	20h
9.6V	72.6	51.2	42.8	30.5	22.4	17.4	11.3	9.90	6.98	5.51	4.50	3.83	2.48	1.35
9.9V	70.3	50.1	42.3	30.3	21.8	17.0	11.2	9.79	6.86	5.46	4.41	3.71	2.48	1.35
10.2V	67.7	49.2	41.3	30.0	21.4	16.7	11.1	9.68	6.75	5.40	4.36	3.69	2.48	1.35
10.5V	64.9	47.3	39.5	29.3	20.3	15.8	11.0	9.56	6.64	5.29	4.32	3.65	2.48	1.35
10.8V	63.8	46.4	38.8	28.2	18.0	13.8	10.3	9.00	6.41	5.18	4.28	3.60	2.48	1.35

All mentioned values are average values

LC-QA1224P/AP

CHARGING METHOD (25°C)

Cycle use	Control voltage: 13.6V - 13.8V Initial current: 3.60A or smaller
------------------	---

CUT-OFF VOLTAGE

Discharge current	1.20A - 4.80A	4.80A - 12.0A	12.0A - 24.0A	24.0A - 48.0A	48.0A - 72.0A
Cut-off voltage	10.5V	10.2V	9.9V	9.3V	8.7V

INFLUENCE OF TEMPERATURE ON TRICKLE LIFE

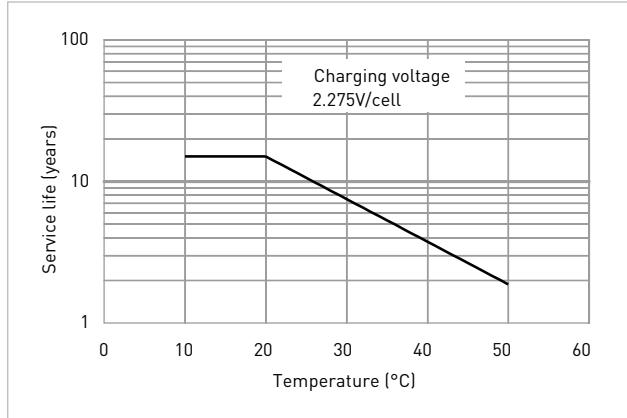

RESIDUAL CAPACITY TEST RESULT

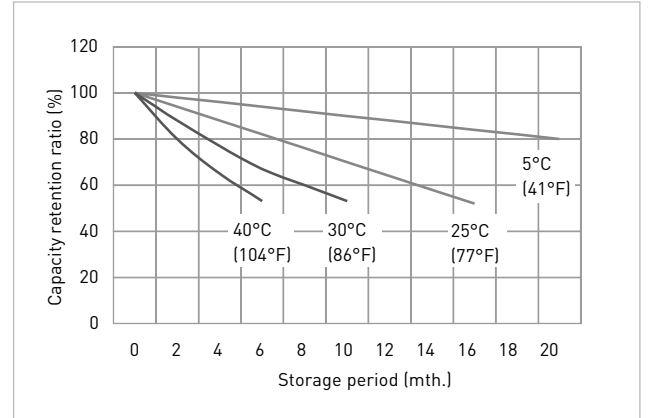

CONSTANT-VOLTAGE CONSTANT-CURRENT CHARGE CHARACTERISTICS FOR TRICKLE USE

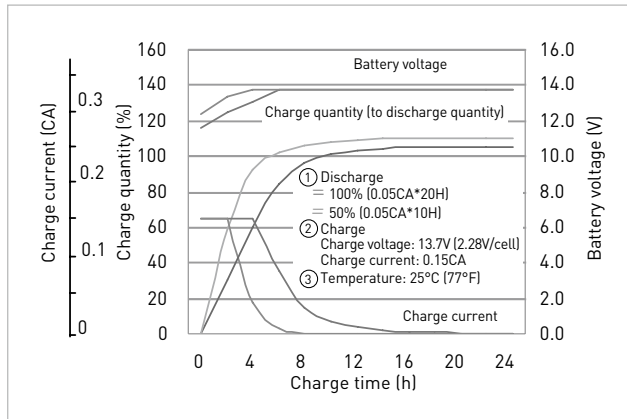

DISCHARGE CAPACITY BY TEMPERATURE AND BY DISCHARGE CURRENT

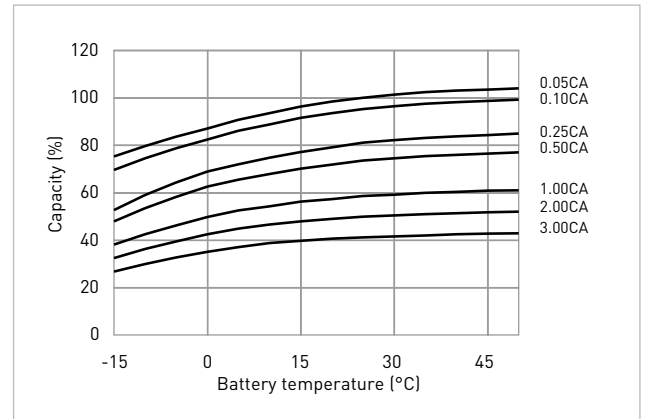

DISCHARGE CHARACTERISTICS

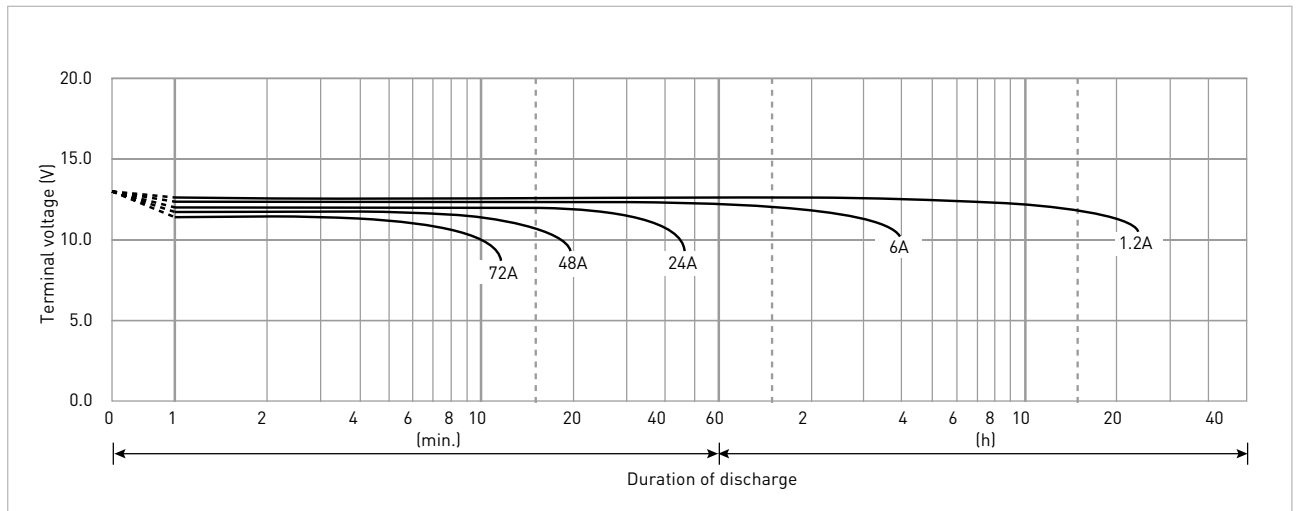

LC-QA1242P

FOR STANDBY POWER SUPPLIES.
EXPECTED TRICKLE DESIGN LIFE: 15 YEARS AT 20°C.

DIMENSIONS (MM)

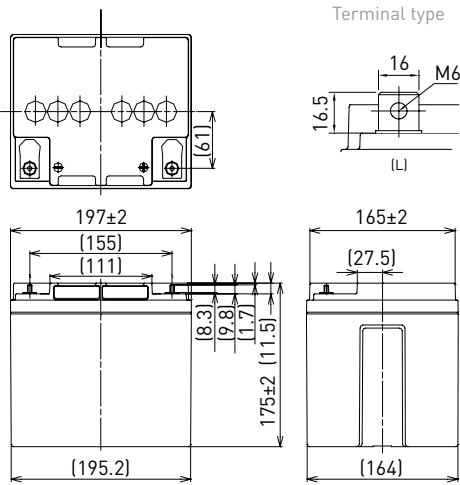

Contents indicated (including the recycle marking, etc.) are subject to change without notice. Battery case resin: flame-retardant (UL94 V-0)

Specifications		LC-QA1242P
Nominal voltage (V)		12
Nominal capacity	20 hours rate (Ah)	42.0
Dimensions	Length (mm)	165
	Width (mm)	197
	Total height (mm)	180
Approx. mass (kg)		15.5
Terminal type		M6 bolt/nut
Capacity (25°C)	20 hours rate (Ah)	47.0
	10 hours rate (Ah)	45.0
	3 hours rate (Ah)	36.0
	1 hour rate (Ah)	29.0
Impedance (mΩ)	Fully charged battery (25°C)	8
Temperature dependency of capacity (%) - 20 hours rate	40°C	102
	25°C	100
	0°C	85
	-15°C	65
Remaining capacity (25°C)	After 3 months (%)	91
	After 6 months (%)	82
	After 12 months (%)	64

DURATION OF DISCHARGE VS. DISCHARGE CURRENT

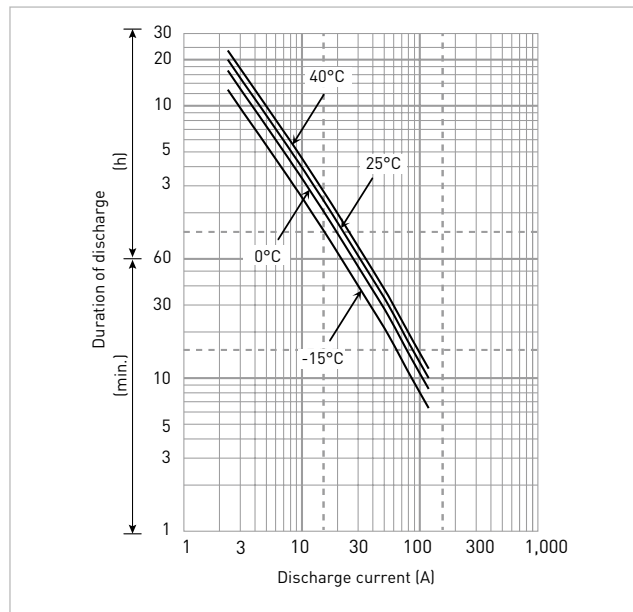

WATT TABLE (25°C)

(Wattage/battery)

Cut-off	10min.	15min.	20min.	30min.	45min.	1h	1.5h	2h	3h	4h	5h	6h	10h	20h
9.6V	1,313	993	805	621	444	354	256	220	156	121	101	86.0	55.2	28.1
9.9V	1,252	930	775	597	435	349	253	215	152	117	98.9	84.5	54.3	28.1
10.2V	1,187	868	724	574	425	344	249	205	149	116	97.6	83.2	53.9	28.1
10.5V	1,176	847	694	545	414	327	237	202	142	113	93.4	79.4	50.4	26.9
10.8V	1,170	826	673	517	405	320	231	195	139	110	90.2	76.9	49.1	25.1

AMPERE TABLE (25°C)

(Ampere/battery)

Cut-off	10min.	15min.	20min.	30min.	45min.	1h	1.5h	2h	3h	4h	5h	6h	10h	20h
9.6V	123	94.5	81.0	60.1	39.3	29.8	23.0	17.8	12.5	10.4	8.44	7.43	4.50	2.36
9.9V	121	93.4	79.9	58.4	39.0	29.6	22.3	17.7	12.3	10.3	8.35	7.37	4.50	2.36
10.2V	119	92.3	78.8	57.3	38.9	29.4	20.7	17.4	12.0	10.2	8.30	7.31	4.50	2.36
10.5V	116	90.0	77.6	56.3	38.8	29.3	20.1	16.9	11.9	10.1	8.26	7.20	4.50	2.36
10.8V	107	86.6	75.4	55.1	37.4	28.1	19.1	16.4	11.5	9.90	8.21	7.09	4.50	2.36

All mentioned values are average values

LC-QA1242P

CHARGING METHOD (25°C)

Cycle use	Control voltage: 13.6V - 13.8V Initial current: 6.30A or smaller
------------------	---

CUT-OFF VOLTAGE

Discharge current	2.10A - 8.40A	8.40A - 21.0A	21.0A - 42.0A	42.0A - 84.0A	84.0A - 126A
Cut-off voltage	10.5V	10.2V	9.9V	9.3V	8.7V

INFLUENCE OF TEMPERATURE ON TRICKLE LIFE

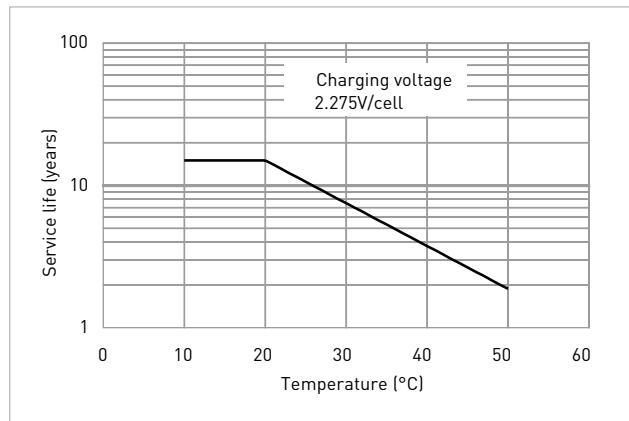

RESIDUAL CAPACITY TEST RESULT

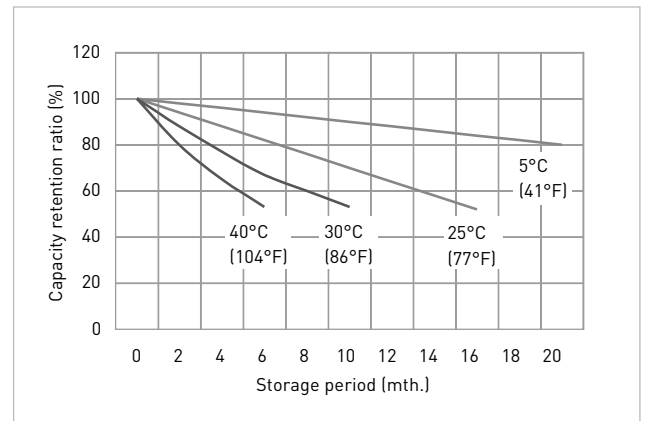

CONSTANT-VOLTAGE CONSTANT-CURRENT CHARGE CHARACTERISTICS FOR TRICKLE USE

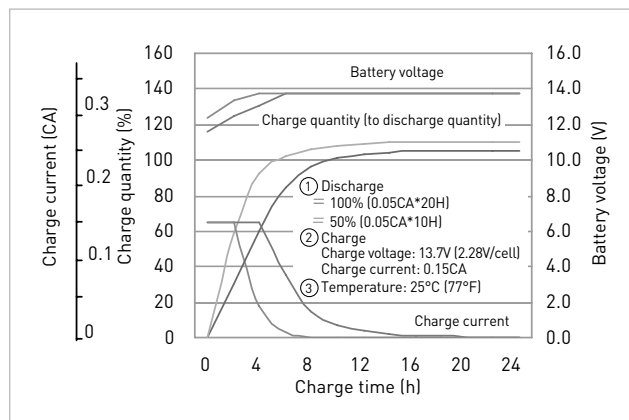

DISCHARGE CAPACITY BY TEMPERATURE AND BY DISCHARGE CURRENT

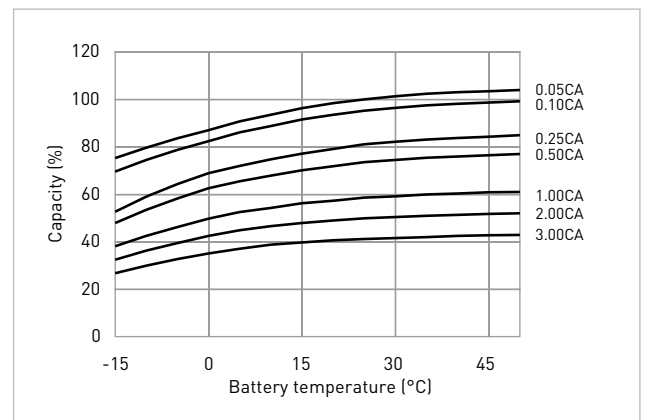

DISCHARGE CHARACTERISTICS

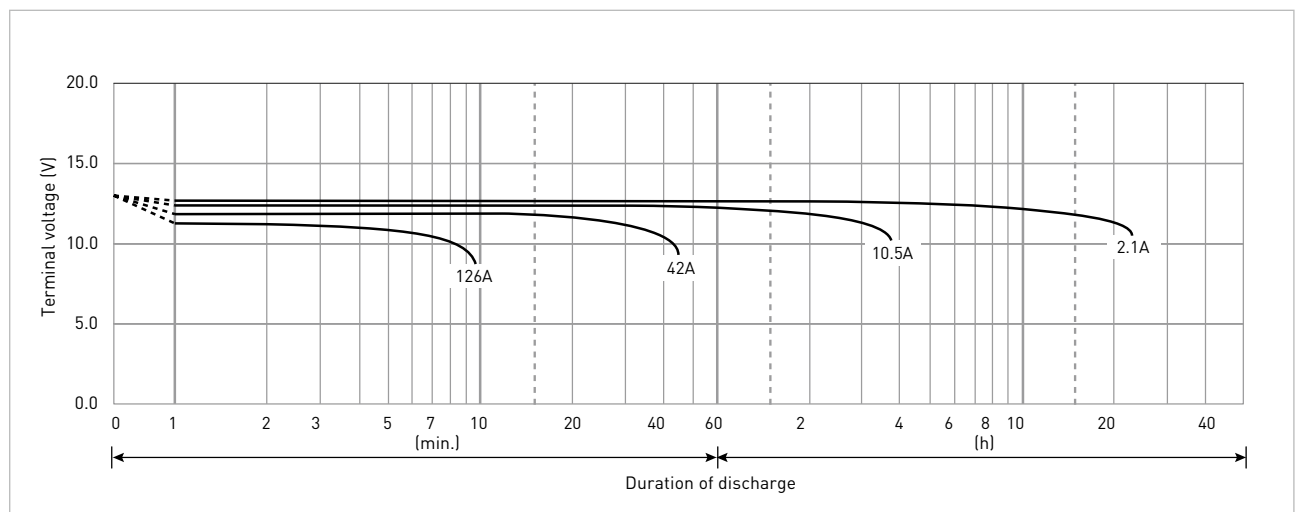

LC-QA1270P

FOR STANDBY POWER SUPPLIES.
EXPECTED TRICKLE DESIGN LIFE: 15 YEARS AT 20°C.

DIMENSIONS (MM)



Contents indicated (including the recycle marking, etc.) are subject to change without notice. Battery case resin: flame-retardant (UL94 V-0)

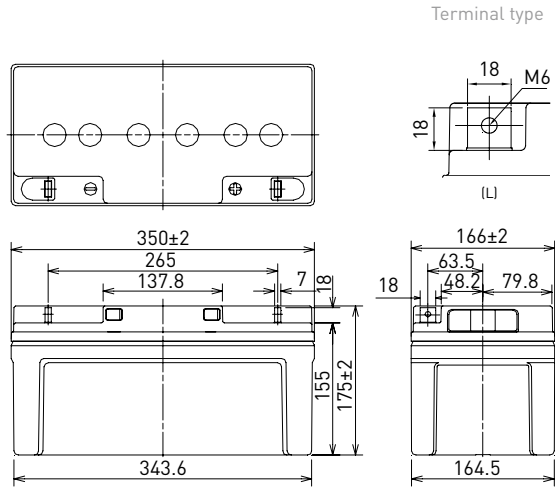

Specifications		LC-QA1270P
Nominal voltage (V)		12
Nominal capacity	20 hours rate (Ah)	70
Dimensions	Length (mm)	166
	Width (mm)	350
	Total height (mm)	175
Approx. mass (kg)		23.5
Terminal type		M6 bolt/nut
Capacity (25°C)	20 hours rate (Ah)	71
	10 hours rate (Ah)	65
	3 hours rate (Ah)	55.0
	1 hour rate (Ah)	46.0
Impedance (mΩ)	Fully charged battery (25°C)	5
	Temperature dependency of capacity (%) - 20 hours rate	
	40°C	102
	25°C	100
	0°C	85
	-15°C	65
Remaining capacity (25°C)	After 3 months (%)	91
	After 6 months (%)	82
	After 12 months (%)	64

DURATION OF DISCHARGE VS. DISCHARGE CURRENT

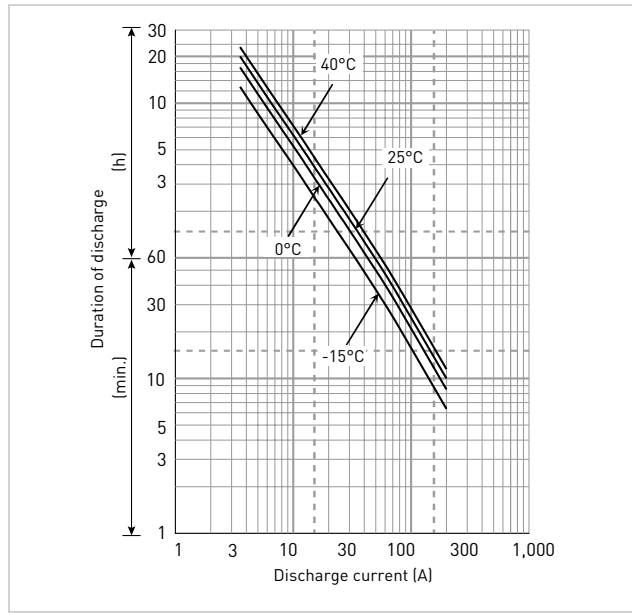

WATT TABLE (25°C)

(Wattage/battery)

Cut-off	10min.	15min.	20min.	30min.	45min.	1h	1.5h	2h	3h	4h	5h	6h	10h	20h
9.6V	1,977	1,504	1,234	916	676	549	386	333	240	181	148	130	75.5	41.7
9.9V	1,947	1,491	1,227	909	660	520	367	323	234	177	146	127	74.0	41.5
10.2V	1,867	1,463	1,197	899	655	519	365	311	224	168	138	122	73.1	41.2
10.5V	1,814	1,436	1,173	884	641	509	358	306	221	166	137	120	73.0	39.8
10.8V	1,704	1,357	1,153	865	626	499	351	299	219	165	135	119	12.5	39.4

AMPERE TABLE (25°C)

(Ampere/battery)

Cut-off	10min.	15min.	20min.	30min.	45min.	1h	1.5h	2h	3h	4h	5h	6h	10h	20h
9.6V	200	146	118	85.9	62.8	48.4	34.8	27.1	19.4	15.0	12.5	10.5	6.50	3.53
9.9V	199	144	117	85.0	61.2	47.7	33.9	27.0	19.1	14.9	12.4	10.4	6.50	3.53
10.2V	197	140	116	83.8	60.9	47.3	33.7	26.8	18.9	14.8	12.3	10.3	6.50	3.53
10.5V	187	136	110	82.7	59.5	45.6	33.3	26.7	18.4	14.7	12.1	10.2	6.50	3.53
10.8V	177	132	108	81.4	51.1	41.0	29.4	24.9	17.8	14.4	12.0	10.1	6.50	3.47

All mentioned values are average values

LC-QA1270P

CHARGING METHOD (25°C)

Cycle use	Control voltage: 13.6V - 13.8V Initial current: 10.5A or smaller
------------------	---

CUT-OFF VOLTAGE

Discharge current	3.50A - 14.0A	14.0A - 35.0A	35.0A - 70.0A	70.0A - 140A	140A - 210A
Cut-off voltage	10.5V	10.2V	9.9V	9.3V	8.7V

INFLUENCE OF TEMPERATURE ON TRICKLE LIFE

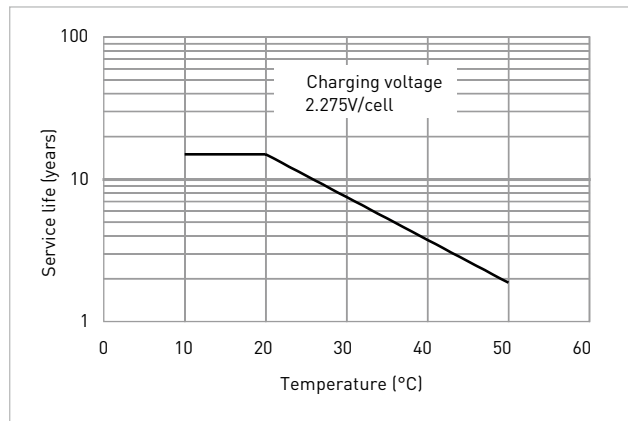

RESIDUAL CAPACITY TEST RESULT

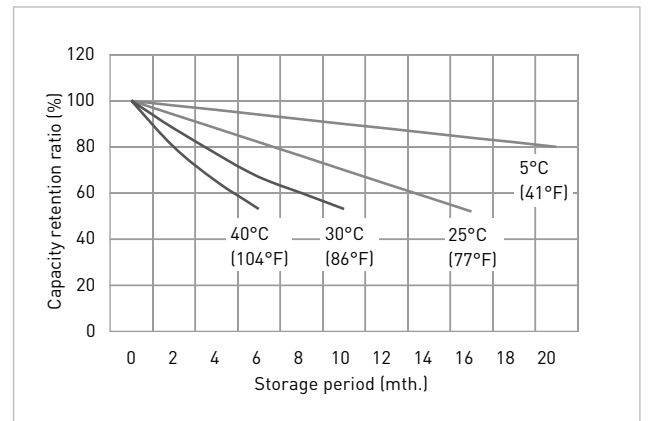

CONSTANT-VOLTAGE CONSTANT-CURRENT CHARGE CHARACTERISTICS FOR TRICKLE USE

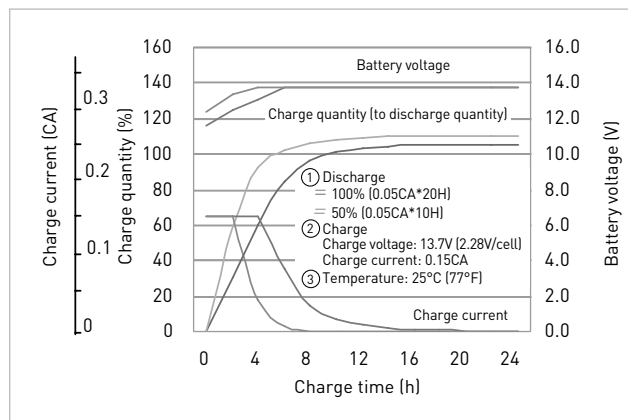

DISCHARGE CAPACITY BY TEMPERATURE AND BY DISCHARGE CURRENT

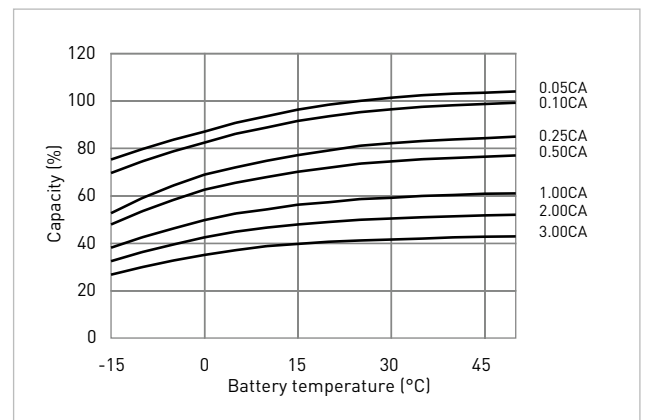

DISCHARGE CHARACTERISTICS

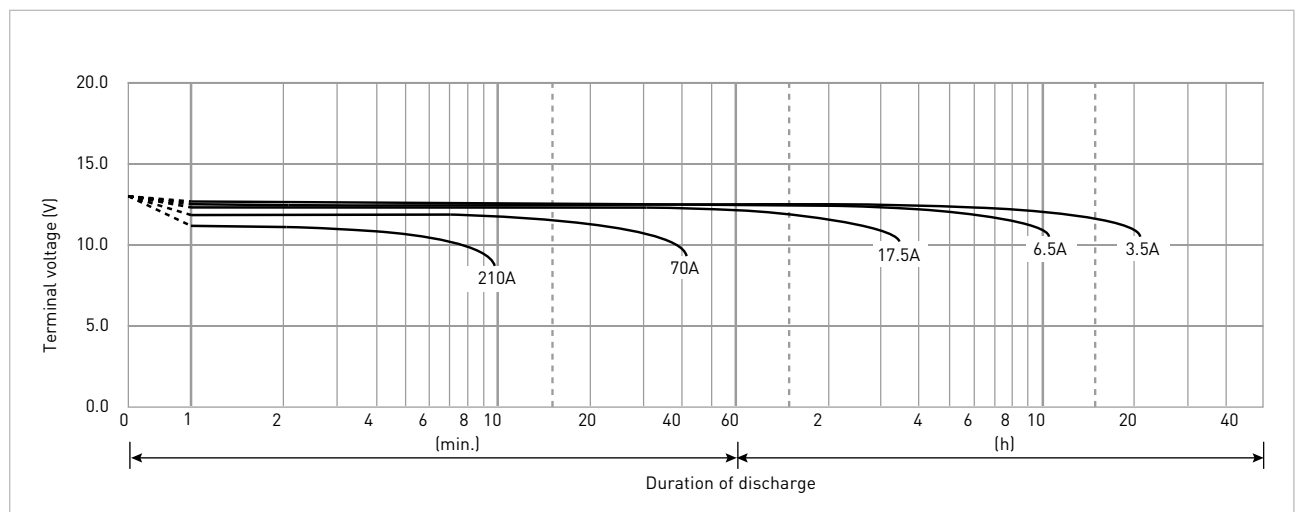

LC-QA12110TP

FOR STANDBY POWER SUPPLIES.
EXPECTED TRICKLE DESIGN LIFE: 15 YEARS AT 20°C.

DIMENSIONS (MM)



Contents indicated (including the recycle marking, etc.) are subject to change without notice. Battery case resin: flame-retardant (UL94 V-0)

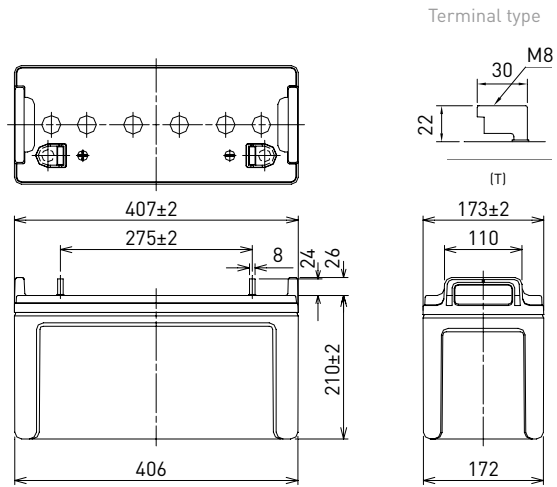

Specifications		LC-QA12110TP
Nominal voltage (V)		12
Nominal capacity	20 hours rate (Ah)	110
	Length (mm)	173
	Width (mm)	407
Dimensions	Total height (mm)	236
	Approx. mass (kg)	36.0
Terminal type		M8 T-shape
Capacity (25°C)	20 hours rate (Ah)	110
	10 hours rate (Ah)	101
	3 hours rate (Ah)	86
	1 hour rate (Ah)	75
Impedance (mΩ) Fully charged battery (25°C)		4
Temperature dependency of capacity (%) – 20 hours rate	40°C	102
	25°C	100
	0°C	85
	-15°C	65
Remaining capacity (25°C)	After 3 months (%)	91
	After 6 months (%)	82
	After 12 months (%)	64

DURATION OF DISCHARGE VS. DISCHARGE CURRENT

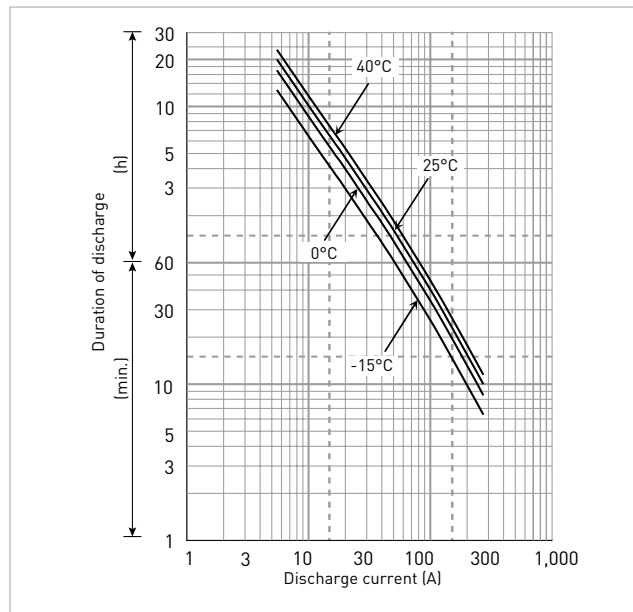

WATT TABLE (25°C)

(Wattage/battery)

Cut-off	10min.	15min.	20min.	30min.	45min.	1h	1.5h	2h	3h	4h	5h	6h	10h	20h
9.6V	2,987	2,270	1,872	1,391	1,017	793	578	482	353	279	232	197	124	63.7
9.9V	2,920	2,215	1,827	1,358	995	772	563	469	346	273	225	192	120	63.2
10.2V	2,855	2,136	1,761	1,314	984	751	548	463	340	267	218	186	118	62.7
10.5V	2,764	2,110	1,748	1,303	968	730	532	453	334	264	215	185	117	62.1
10.8V	2,522	2,010	1,739	1,261	933	720	525	442	328	258	212	183	116	61.6

AMPERE TABLE (25°C)

(Ampere/battery)

Cut-off	10min.	15min.	20min.	30min.	45min.	1h	1.5h	2h	3h	4h	5h	6h	10h	20h
9.6V	272	212	175	133	96.7	76.7	53.6	43.2	30.2	23.3	19.7	16.1	10.4	5.50
9.9V	269	211	174	132	94.0	76.4	52.6	42.8	29.6	23.1	19.4	16.0	10.3	5.50
10.2V	268	210	172	130	93.5	75.9	52.1	42.3	29.4	22.9	19.1	15.9	10.2	5.50
10.5V	245	198	164	128	92.5	75.4	51.5	41.8	28.8	22.6	19.0	15.7	10.1	5.50
10.8V	232	192	160	126	79.9	65.4	46.4	39.7	28.1	22.3	18.9	15.5	10.0	5.39

All mentioned values are average values

LC-QA12110TP

CHARGING METHOD (25°C)

Cycle use	Control voltage: 13.6V - 13.8V Initial current: 16.5A or smaller
------------------	---

CUT-OFF VOLTAGE

Discharge current	5.50A - 22.0A	22.0A - 55.0A	55.0A - 110A	110A - 220A	220A - 330A
Cut-off voltage	10.5V	10.2V	9.9V	9.3V	8.7V

INFLUENCE OF TEMPERATURE ON TRICKLE LIFE

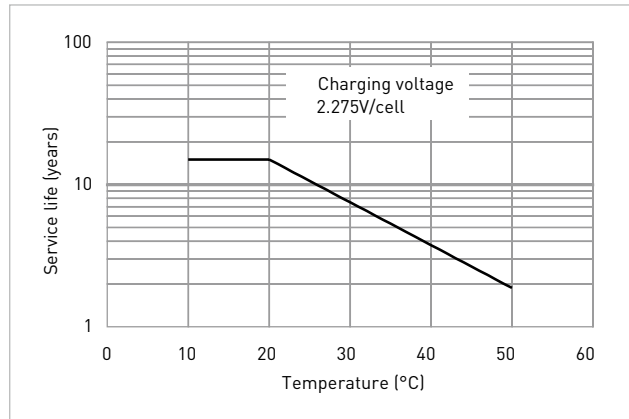

RESIDUAL CAPACITY TEST RESULT

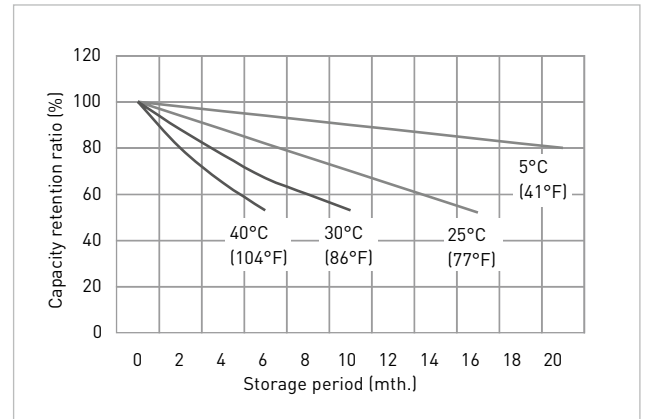

CONSTANT-VOLTAGE CONSTANT-CURRENT CHARGE CHARACTERISTICS FOR TRICKLE USE

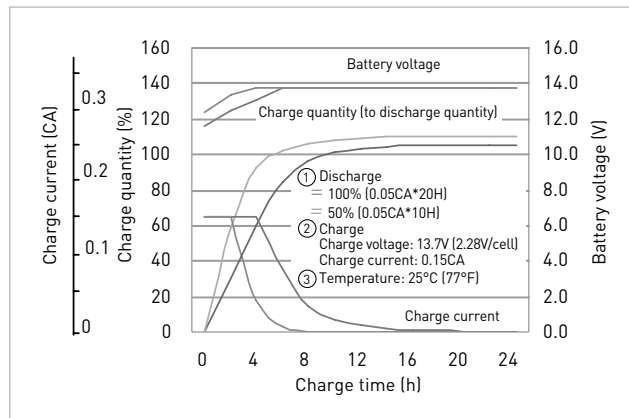

DISCHARGE CAPACITY BY TEMPERATURE AND BY DISCHARGE CURRENT

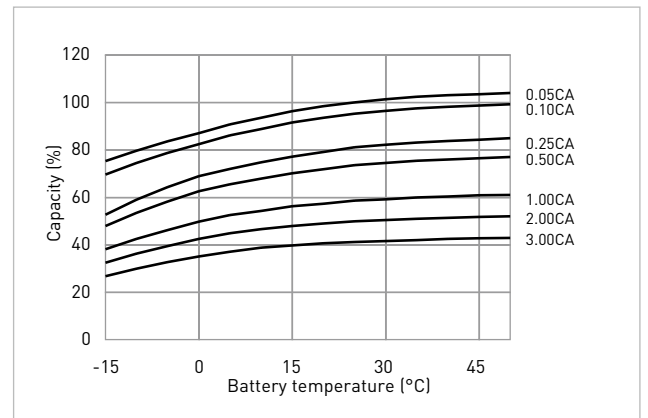

DISCHARGE CHARACTERISTICS

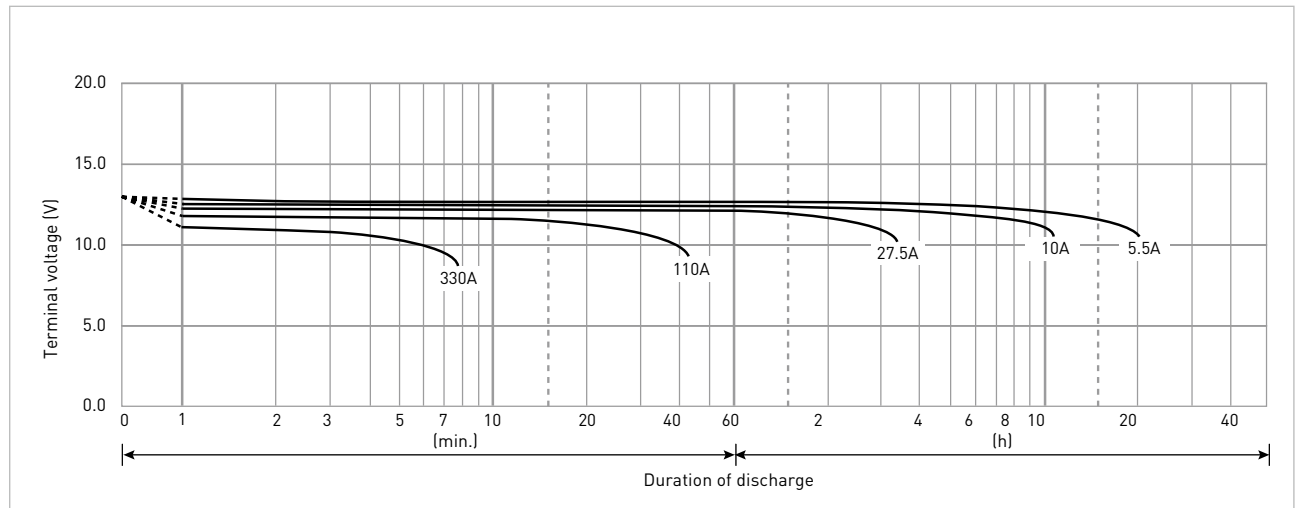

UP-VW0645P1

FOR STANDBY POWER SUPPLIES.
 EXPECTED TRICKLE DESIGN LIFE: 6 - 9 YEARS AT 20°C
 ACCORDING TO EUROBAT.

DIMENSIONS (MM)

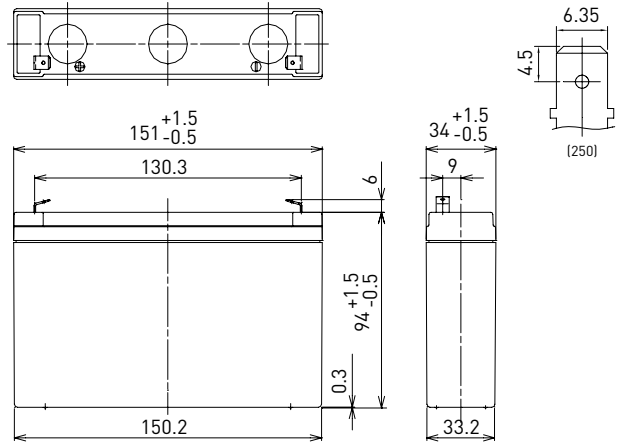

Contents indicated (including the recycle marking, etc.) are subject to change without notice. Battery case resin: flame-retardant (UL94 V-0)

Specifications		UP-VW0645P1
Nominal voltage (V)		6
Rated power	10 minutes rate (W)	135
Nominal capacity	20 hours rate (Ah)	7.8
Dimensions	Length (mm)	34
	Width (mm)	151
	Total height (mm)	100
Approx. mass (kg)		1.30
Terminal type		Faston 250
Power (25°C)	30 minutes rate (W)	56.0
	15 minutes rate (W)	98
	10 minutes rate (W)	135
	5 minutes rate (W)	205
Impedance (mΩ)	Fully charged battery (25°C)	10
Temperature dependency of capacity (%) – 20 hours rate	40°C	102
	25°C	100
	0°C	85
	-15°C	65
Remaining capacity (25°C)	After 3 months (%)	91
	After 6 months (%)	82
	After 12 months (%)	64

DURATION OF DISCHARGE VS. DISCHARGE CURRENT

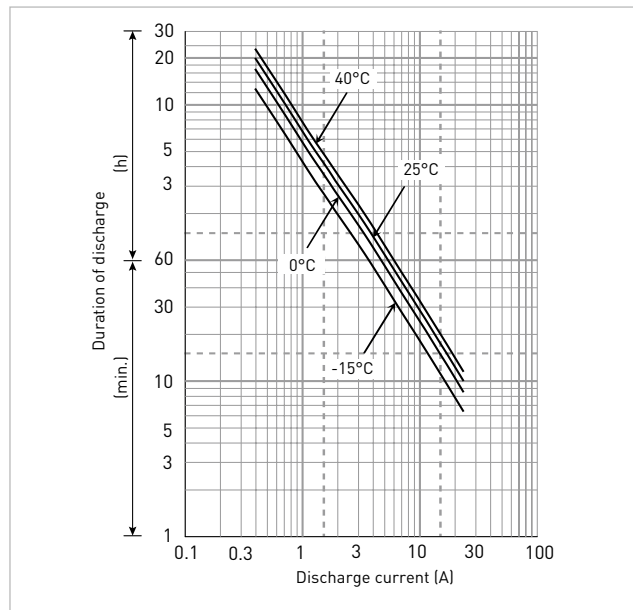

WATT TABLE (25°C)

(Wattage/battery)

Cut-off	3min.	5min.	10min.	15min.	20min.	30min.	45min.	1h	1.5h	2h	3h	4h	5h	6h	10h	20h
4.80V	265	205	135	97.5	79.5	56.0	41.1	32.8	22.6	17.5	13.0	9.99	8.25	6.63	4.39	2.38
4.95V	254	200	131	97.2	78.9	55.9	40.8	32.5	22.1	17.3	12.9	9.92	8.18	6.60	4.37	2.37
5.10V	245	195	129	96.5	78.0	55.5	40.4	32.2	21.7	16.9	12.8	9.86	8.12	6.55	4.33	2.37
5.25V	231	180	123	93.4	75.4	55.0	39.3	31.5	20.8	16.4	12.6	9.85	8.07	6.48	4.31	2.36
5.40V	217	165	117	90.0	73.0	54.5	39.1	30.9	20.6	15.5	12.4	9.66	7.85	6.37	4.26	2.35

AMPERE TABLE (25°C)

(Ampere/battery)

Cut-off	3min.	5min.	10min.	15min.	20min.	30min.	45min.	1h	1.5h	2h	3h	4h	5h	6h	10h	20h
4.80V	47.7	36.8	23.9	17.0	13.7	9.57	6.99	5.57	3.82	2.95	2.19	1.67	1.38	1.11	0.732	0.397
4.95V	45.8	35.9	23.5	16.9	13.6	9.55	6.95	5.50	3.75	2.93	2.17	1.66	1.37	1.10	0.729	0.396
5.10V	44.1	35.0	23.0	16.8	13.5	9.49	6.88	5.46	3.67	2.86	2.15	1.65	1.36	1.09	0.721	0.394
5.25V	41.6	32.3	22.0	16.3	13.0	9.40	6.70	5.35	3.53	2.77	2.11	1.64	1.35	1.08	0.718	0.393
5.40V	39.0	29.6	20.9	15.7	12.6	9.32	6.67	5.25	3.50	2.62	2.08	1.62	1.31	1.06	0.710	0.391

All mentioned values are average values

UP-VW0645P1

CHARGING METHOD (25°C)

Cycle use	Control voltage: 6.80V - 6.90V Initial current: 1.20A or smaller
------------------	---

CUT-OFF VOLTAGE

Discharge current	0.400A - 1.60A	1.60A - 4.00A	4.00A - 8.00A	8.00A - 16.0A	16.0A - 24.0A
Cut-off voltage	5.25V	5.10V	4.95V	4.65V	4.35V

INFLUENCE OF TEMPERATURE ON TRICKLE LIFE

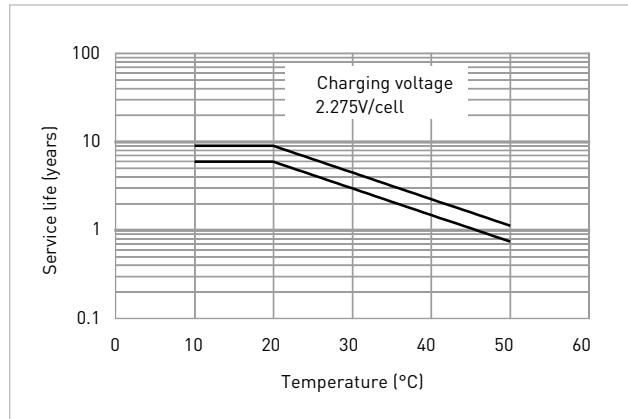

RESIDUAL CAPACITY TEST RESULT

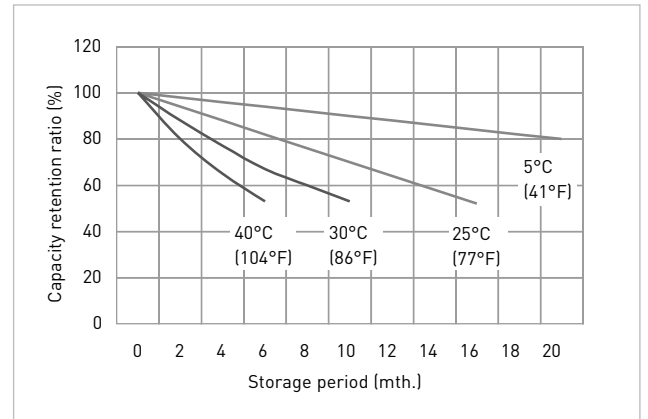

CONSTANT-VOLTAGE CONSTANT-CURRENT CHARGE CHARACTERISTICS FOR TRICKLE USE

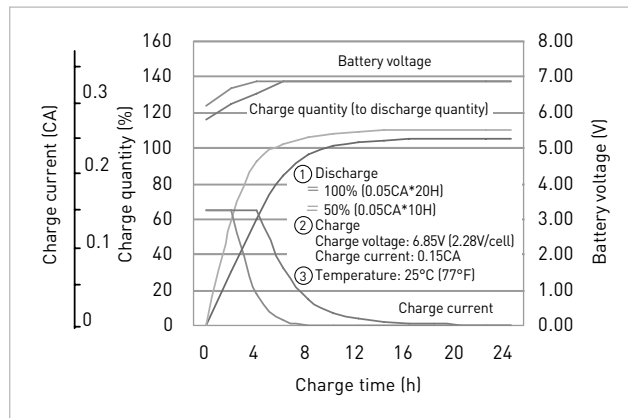

DISCHARGE CAPACITY BY TEMPERATURE AND BY DISCHARGE CURRENT

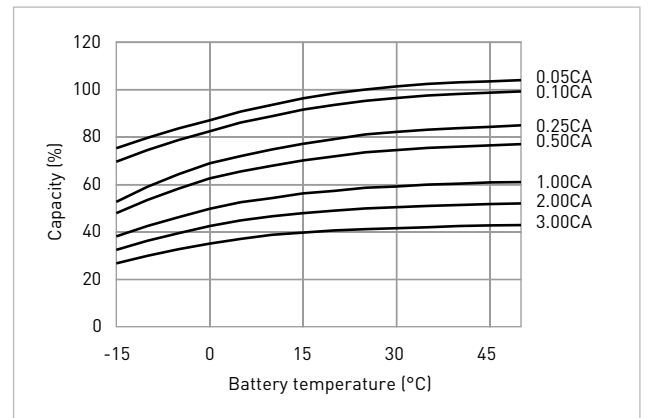

DISCHARGE CHARACTERISTICS

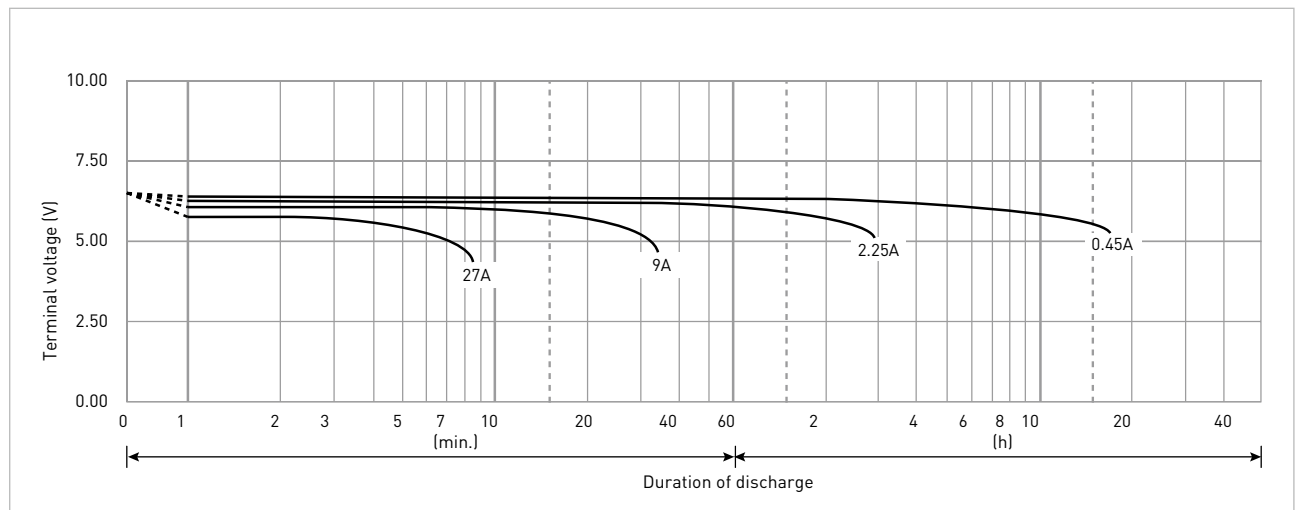

UP-VW1220P1

FOR STANDBY POWER SUPPLIES.
 EXPECTED TRICKLE DESIGN LIFE: 6 - 9 YEARS AT 20°C
 ACCORDING TO EUROBAT.

DIMENSIONS (MM)

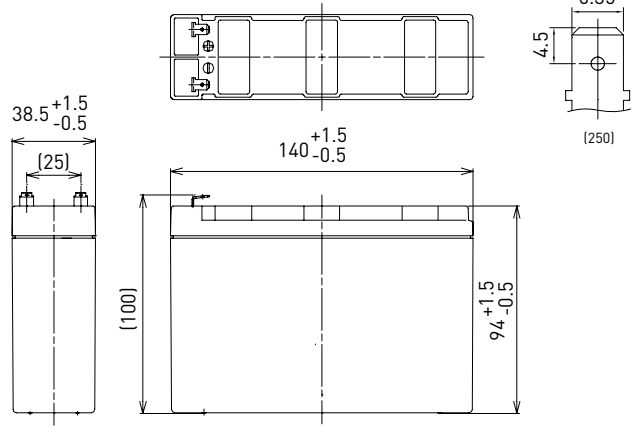

Contents indicated (including the recycle marking, etc.) are subject to change without notice. Battery case resin: flame-retardant (UL94 V-0)

Specifications		UP-VW1220P1
Nominal voltage (V)		12
Rated power	10 minutes rate (W)	120
Nominal capacity	20 hours rate (Ah)	4.0
Dimensions	Length (mm)	38.5
	Width (mm)	140
	Total height (mm)	100
Approx. mass (kg)		1.30
Terminal type		Faston 250
Power (25°C)	30 minutes rate (W)	57.0
	15 minutes rate (W)	91
	10 minutes rate (W)	120
	5 minutes rate (W)	180
Impedance (mΩ)	Fully charged battery (25°C)	40
Temperature dependency of capacity (%) – 20 hours rate	40°C	102
	25°C	100
	0°C	85
	-15°C	65
Remaining capacity (25°C)	After 3 months (%)	91
	After 6 months (%)	82
	After 12 months (%)	64

DURATION OF DISCHARGE VS. DISCHARGE CURRENT

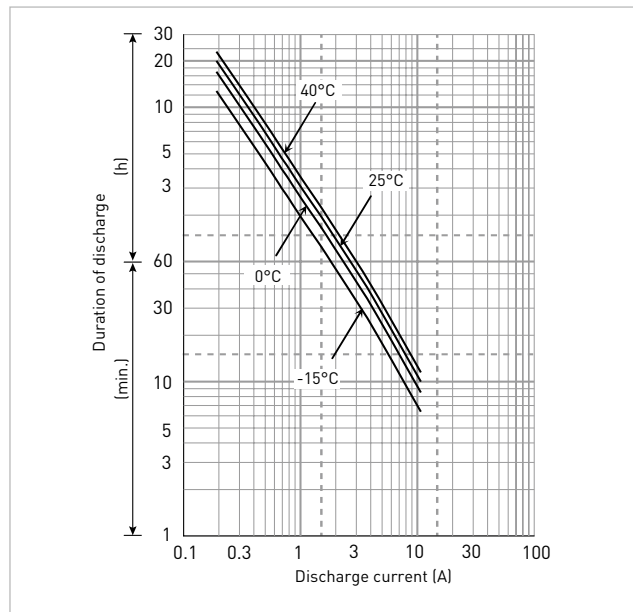

WATT TABLE (25°C)

(Wattage/battery)

Cut-off	3min.	5min.	10min.	15min.	20min.	30min.	45min.	1h	1.5h	2h	3h	4h	5h	6h	10h	20h
9.6V	237	180	120	91.0	75.0	57.0	41.8	33.4	23.0	17.8	13.2	10.2	8.39	6.75	4.47	2.42
9.9V	227	173	116	89.1	74.0	54.5	39.3	31.6	21.3	16.7	12.5	9.56	7.88	6.36	4.21	2.29
10.2V	217	167	113	87.0	73.0	52.0	37.9	30.2	20.3	15.9	12.0	9.24	7.60	6.14	4.05	2.22
10.5V	197	152	108	84.5	69.5	49.5	35.4	28.3	18.7	14.8	11.6	8.86	7.26	5.83	3.88	2.12
10.8V	177	137	102	82.0	66.0	47.0	33.7	26.6	17.8	13.4	10.7	8.33	6.77	5.49	3.68	2.02

AMPERE TABLE (25°C)

(Ampere/battery)

Cut-off	3min.	5min.	10min.	15min.	20min.	30min.	45min.	1h	1.5h	2h	3h	4h	5h	6h	10h	20h
9.6V	21.3	16.1	10.7	7.91	6.47	4.87	3.56	2.84	1.95	1.50	1.11	0.851	0.701	0.563	0.373	0.231
9.9V	20.4	15.6	10.4	7.75	6.38	4.62	3.35	2.68	1.80	1.41	1.05	0.800	0.658	0.530	0.351	0.217
10.2V	19.5	15.0	10.1	7.57	6.29	4.44	3.23	2.56	1.72	1.34	1.01	0.773	0.635	0.512	0.338	0.211
10.5V	17.7	13.7	9.60	7.35	5.99	4.23	3.02	2.41	1.59	1.25	0.971	0.742	0.606	0.487	0.323	0.202
10.8V	15.9	12.3	9.11	7.13	5.69	4.02	2.87	2.26	1.51	1.13	0.895	0.697	0.565	0.458	0.306	0.193

All mentioned values are average values

UP-VW1220P1

CHARGING METHOD (25°C)

Cycle use	Control voltage: 13.6V - 13.8V Initial current: 0.600A or smaller
------------------	--

CUT-OFF VOLTAGE

Discharge current	0.200A - 0.800A	0.800A - 2.00A	2.00A - 4.00A	4.00A - 8.00A	8.00A - 12.0A
Cut-off voltage	10.5V	10.2V	9.9V	9.3V	8.7V

INFLUENCE OF TEMPERATURE ON TRICKLE LIFE

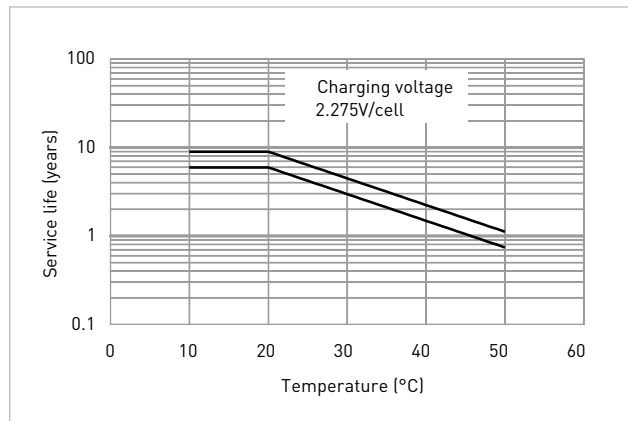

RESIDUAL CAPACITY TEST RESULT

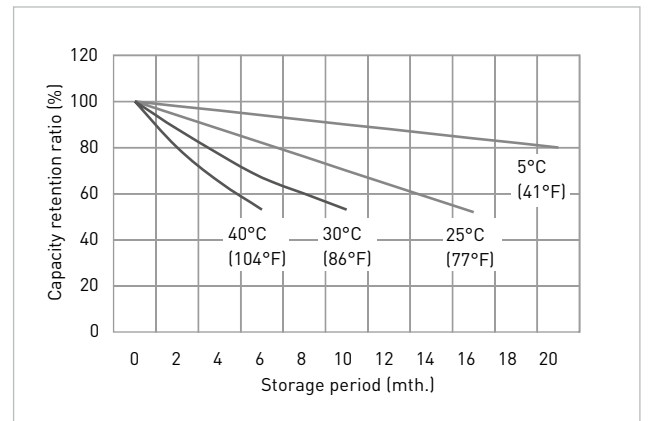

CONSTANT-VOLTAGE CONSTANT-CURRENT CHARGE CHARACTERISTICS FOR TRICKLE USE

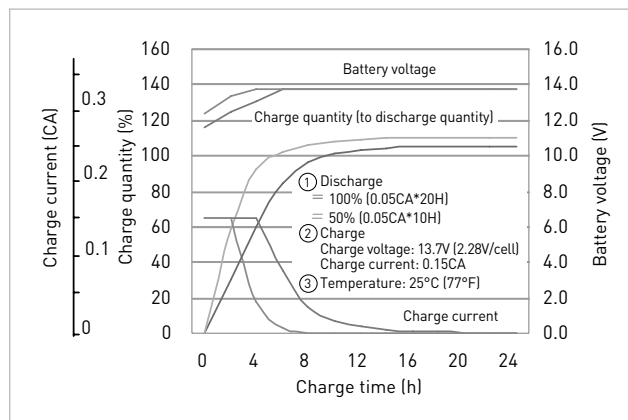

DISCHARGE CAPACITY BY TEMPERATURE AND BY DISCHARGE CURRENT

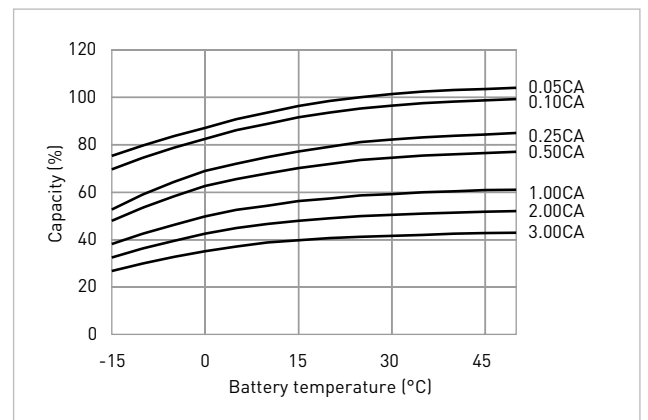

DISCHARGE CHARACTERISTICS

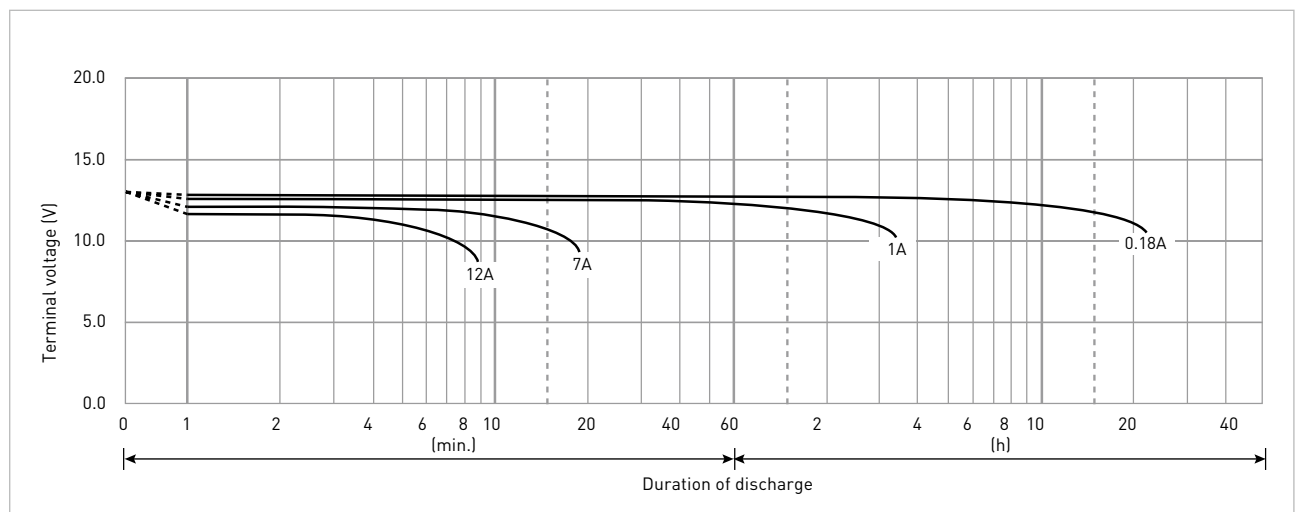

UP-VW1228P1

FOR STANDBY POWER SUPPLIES.
 EXPECTED TRICKLE DESIGN LIFE: 6 – 9 YEARS AT 20°C
 ACCORDING TO EUROBAT.

DIMENSIONS (MM)



Contents indicated (including the recycle marking, etc.) are subject to change without notice. Battery case resin: flame-retardant (UL94 V-0)

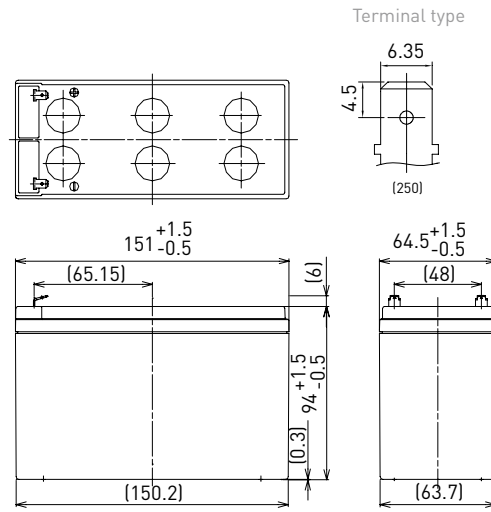

Specifications		UP-VW1228P1
Nominal voltage (V)		12
Rated power	10 minutes rate (W)	200
Nominal capacity	20 hours rate (Ah)	6.2
Dimensions	Length (mm)	64.5
	Width (mm)	151
	Total height (mm)	100
Approx. mass (kg)		2.00
Terminal type		Faston 250
Power (25°C)	30 minutes rate (W)	80
	15 minutes rate (W)	151
	10 minutes rate (W)	200
	5 minutes rate (W)	320
Impedance (mΩ)	Fully charged battery (25°C)	23
Temperature dependency of capacity (%) – 20 hours rate	40°C	102
	25°C	100
	0°C	85
	-15°C	65
Remaining capacity (25°C)	After 3 months (%)	91
	After 6 months (%)	82
	After 12 months (%)	64

DURATION OF DISCHARGE VS. DISCHARGE CURRENT

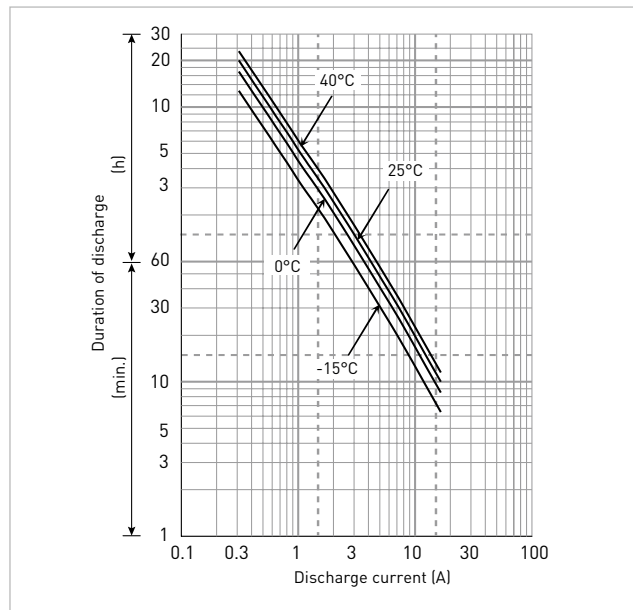

WATT TABLE (25°C)

(Wattage/battery)

Cut-off	3min.	5min.	10min.	15min.	20min.	30min.	45min.	1h	1.5h	2h	3h	4h	5h	6h	10h	20h
9.6V	415	320	200	151	113	80.4	60.0	50.4	37.2	28.8	20.1	15.2	12.5	10.3	6.26	3.01
9.9V	391	274	170	144	109	78.7	59.6	49.2	36.4	28.6	20.0	15.1	12.4	10.1	6.23	3.00
10.2V	365	261	165	137	106	77.0	57.1	47.8	34.5	27.0	19.2	14.8	11.9	9.85	5.97	2.90
10.5V	331	237	158	131	101	74.1	55.6	46.8	33.2	26.2	18.8	14.5	11.8	9.75	5.94	2.89
10.8V	298	213	149	125	96.9	71.2	52.1	43.2	31.0	23.3	17.4	13.4	10.8	9.02	5.53	2.71

AMPERE TABLE (25°C)

(Ampere/battery)

Cut-off	3min.	5min.	10min.	15min.	20min.	30min.	45min.	1h	1.5h	2h	3h	4h	5h	6h	10h	20h
9.6V	35.6	26.9	16.6	13.2	10.7	8.01	5.86	4.67	3.20	2.47	1.83	1.40	1.15	0.926	0.613	0.332
9.9V	33.5	25.6	16.1	12.6	10.3	7.85	5.82	4.55	3.14	2.45	1.82	1.39	1.14	0.922	0.610	0.331
10.2V	31.4	24.4	15.7	11.9	10.0	7.68	5.58	4.43	2.97	2.32	1.74	1.34	1.10	0.885	0.584	0.320
10.5V	28.5	22.1	15.0	11.4	9.57	7.40	5.43	4.33	2.86	2.24	1.68	1.29	1.05	0.876	0.581	0.310
10.8V	25.6	19.9	14.2	10.9	9.17	7.11	5.08	4.00	2.67	2.00	1.58	1.23	1.00	0.810	0.542	0.298

All mentioned values are average values

UP-VW1228P1

CHARGING METHOD (25°C)

Cycle use	Control voltage: 13.6V - 13.8V Initial current: 0.870A or smaller
------------------	--

CUT-OFF VOLTAGE

Discharge current	0.290A - 1.16A	1.16A - 2.90A	2.90A - 5.80A	5.80A - 11.6A	11.6A - 17.4A
Cut-off voltage	10.5V	10.2V	9.9V	9.3V	8.7V

INFLUENCE OF TEMPERATURE ON TRICKLE LIFE

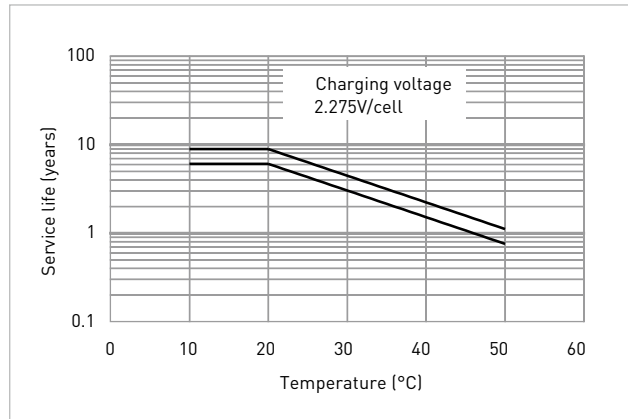

RESIDUAL CAPACITY TEST RESULT

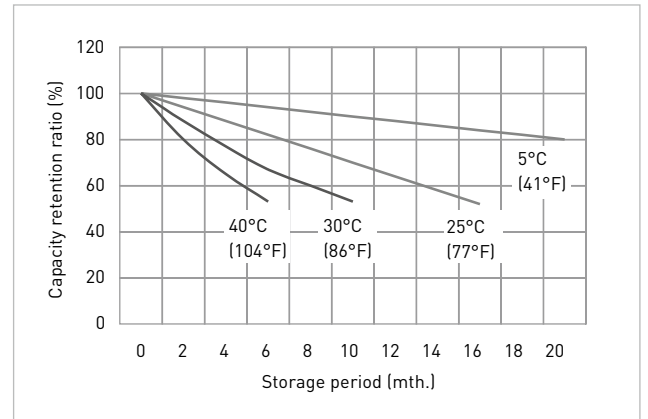

CONSTANT-VOLTAGE CONSTANT-CURRENT CHARGE CHARACTERISTICS FOR TRICKLE USE

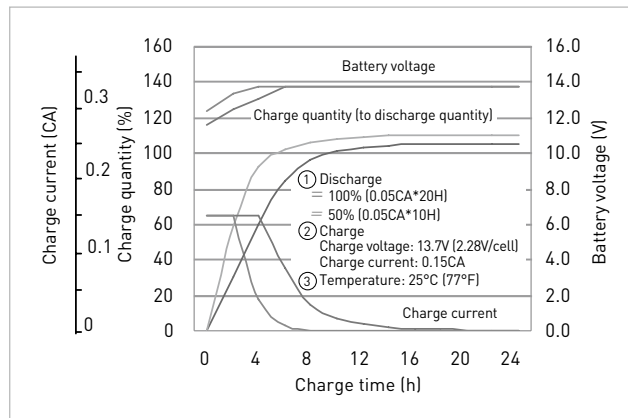

DISCHARGE CAPACITY BY TEMPERATURE AND BY DISCHARGE CURRENT

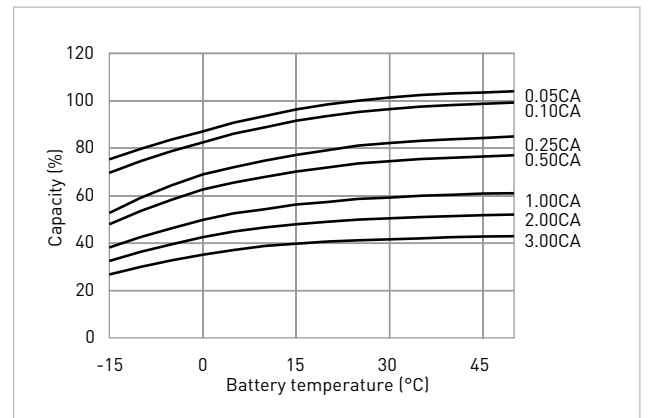

DISCHARGE CHARACTERISTICS

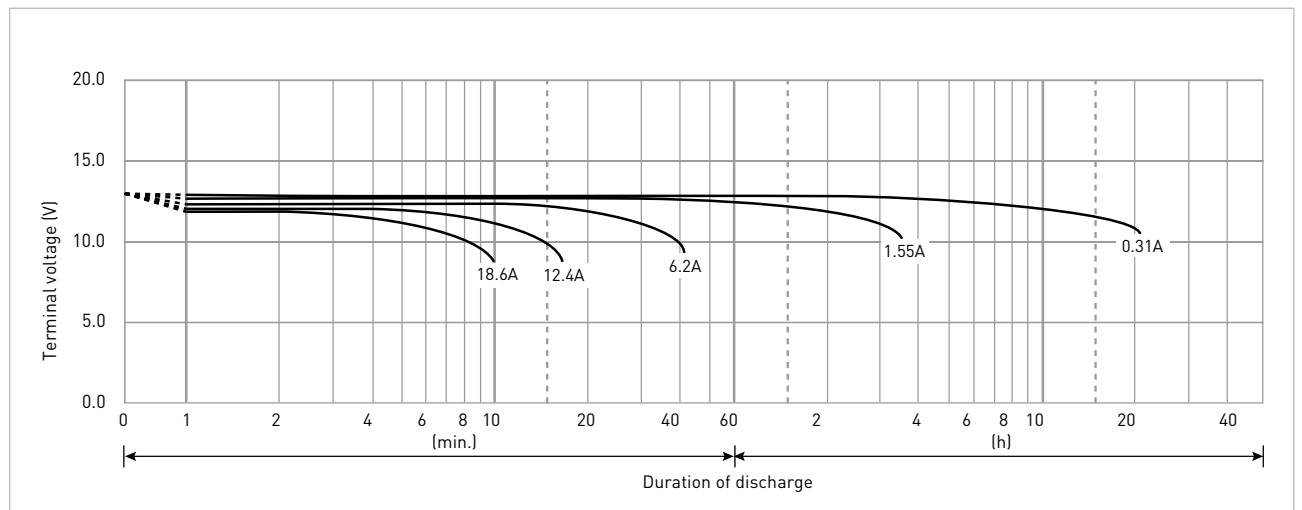

UP-VWA1232P1/P2

FOR STANDBY POWER SUPPLIES.
 EXPECTED TRICKLE DESIGN LIFE: 6 - 9 YEARS AT 20°C
 ACCORDING TO EUROBAT.

DIMENSIONS (MM)



Terminal type (option)

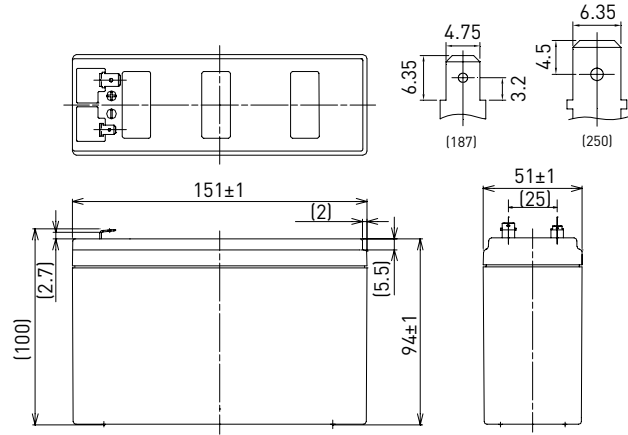

Contents indicated (including the recycle marking, etc.) are subject to change without notice. Battery case resin: flame-retardant (UL94 V-0)

Specifications		UP-VWA1232P1/P2
Nominal voltage (V)		12
Rated power	10 minutes rate (W)	192
Nominal capacity	20 hours rate (Ah)	6.4
Dimensions	Length (mm)	51
	Width (mm)	151
	Total height (mm)	100
Approx. mass (kg)		1.85
Terminal type		Faston 250 & 187/250
Power (25°C)	30 minutes rate (W)	97
	15 minutes rate (W)	165
	10 minutes rate (W)	210
	5 minutes rate (W)	339
Impedance (mΩ)	Fully charged battery (25°C)	25
Temperature dependency of capacity (%) – 20 hours rate	40°C	102
	25°C	100
	0°C	85
	-15°C	65
Remaining capacity (25°C)	After 3 months (%)	91
	After 6 months (%)	82
	After 12 months (%)	64

DURATION OF DISCHARGE VS. DISCHARGE CURRENT

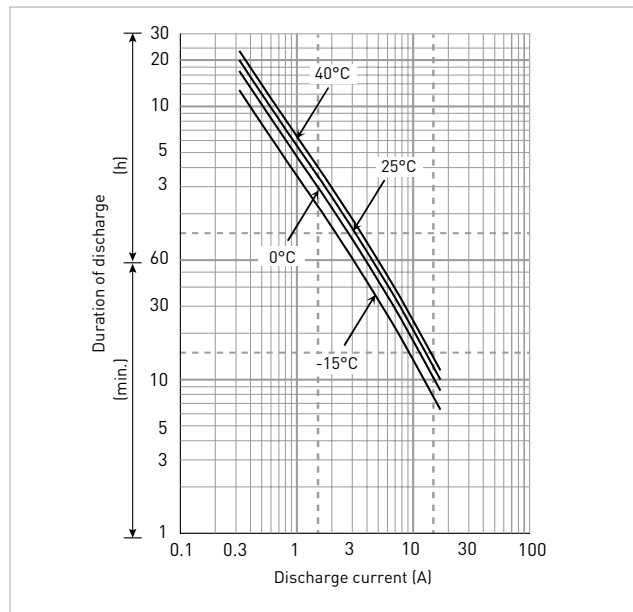

WATT TABLE (25°C)

(Wattage/battery)

Cut-off	3min.	5min.	10min.	15min.	20min.	30min.	45min.	1h	1.5h	2h	3h	4h	5h	6h	10h	20h
9.6V	444	339	210	165	130	97.0	71.1	56.9	41.8	31.5	22.5	16.6	13.8	11.7	7.39	3.86
9.9V	418	290	179	157	127	95.0	70.7	55.5	40.9	31.3	22.4	16.5	13.7	11.4	7.36	3.85
10.2V	391	276	174	149	124	93.0	67.7	53.9	38.8	29.6	21.5	15.9	13.2	11.2	7.04	3.72
10.5V	355	251	166	143	118	89.5	65.9	52.8	37.3	28.6	20.3	15.8	13.1	11.1	7.01	3.71
10.8V	318	226	157	137	113	86.0	61.7	48.8	34.8	25.5	19.5	14.6	12.0	10.3	6.53	3.47

AMPERE TABLE (25°C)

(Ampere/battery)

Cut-off	3min.	5min.	10min.	15min.	20min.	30min.	45min.	1h	1.5h	2h	3h	4h	5h	6h	10h	20h
9.6V	36.9	27.8	17.1	13.7	11.0	8.29	6.06	4.83	3.31	2.56	1.89	1.45	1.19	0.958	0.634	0.344
9.9V	34.7	26.5	16.7	13.0	10.7	8.12	6.02	4.71	3.25	2.54	1.88	1.44	1.18	0.954	0.631	0.343
10.2V	32.5	25.2	16.3	12.3	10.3	7.95	5.77	4.58	3.08	2.40	1.80	1.38	1.14	0.916	0.604	0.331
10.5V	29.5	22.9	15.5	11.8	9.90	7.65	5.61	4.48	2.96	2.32	1.76	1.33	1.07	0.906	0.602	0.320
10.8V	26.4	20.6	14.6	11.3	9.48	7.35	5.26	4.14	2.76	2.07	1.64	1.28	1.03	0.838	0.560	0.309

All mentioned values are average values

UP-VWA1232P1/P2

CHARGING METHOD (25°C)

Cycle use	Control voltage: 13.6V - 13.8V Initial current: 0.900A or smaller
------------------	--

CUT-OFF VOLTAGE

Discharge current	0.300A - 1.20A	1.20A - 3.00A	3.00A - 6.00A	6.00A - 12.0A	12.0A - 18.0A
Cut-off voltage	10.5V	10.2V	9.9V	9.3V	8.7V

INFLUENCE OF TEMPERATURE ON TRICKLE LIFE

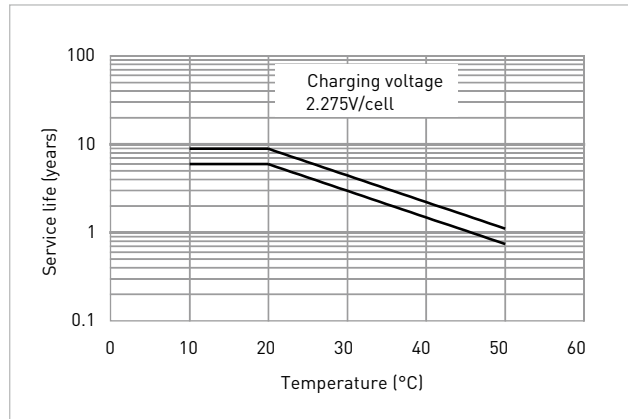

RESIDUAL CAPACITY TEST RESULT

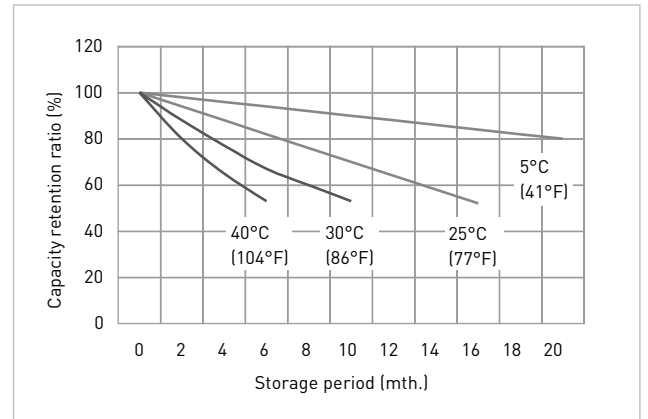

CONSTANT-VOLTAGE CONSTANT-CURRENT CHARGE CHARACTERISTICS FOR TRICKLE USE

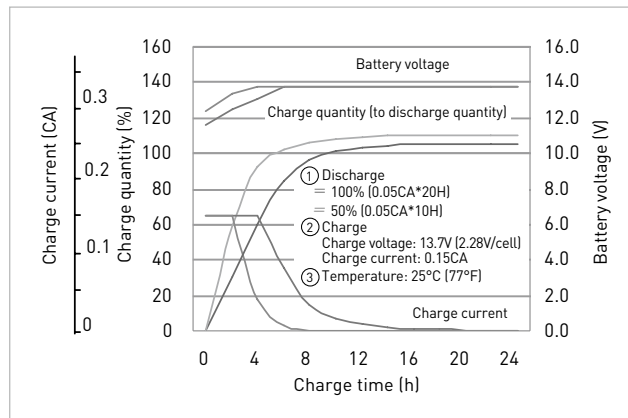

DISCHARGE CAPACITY BY TEMPERATURE AND BY DISCHARGE CURRENT

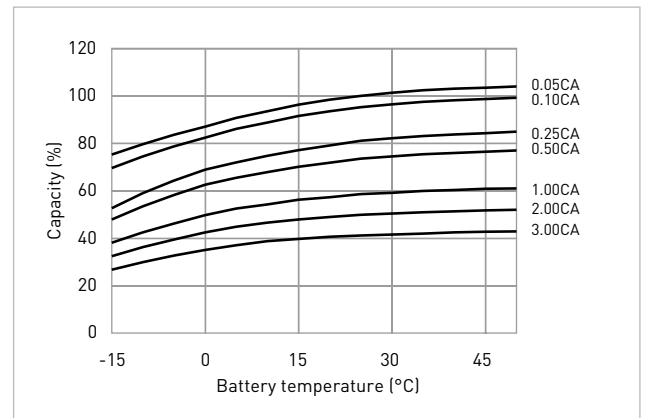

DISCHARGE CHARACTERISTICS

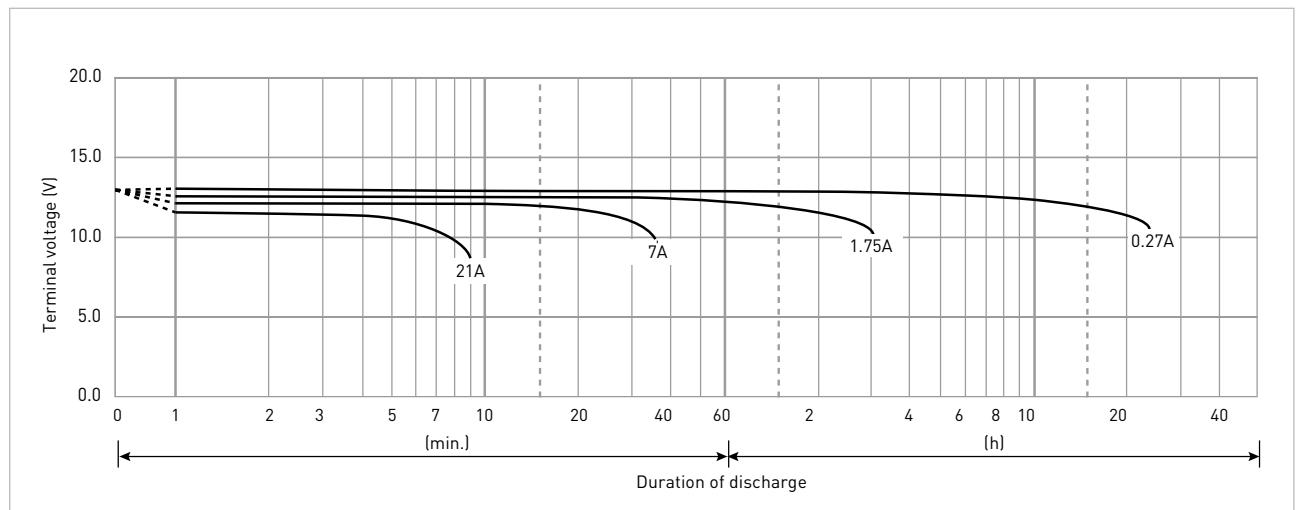

UP-VW1236P1

FOR STANDBY POWER SUPPLIES.
 EXPECTED TRICKLE DESIGN LIFE: 6 - 9 YEARS AT 20°C
 ACCORDING TO EUROBAT.

DIMENSIONS (MM)



Contents indicated (including the recycle marking, etc.) are subject to change without notice. Battery case resin: flame-retardant (UL94 V-0)

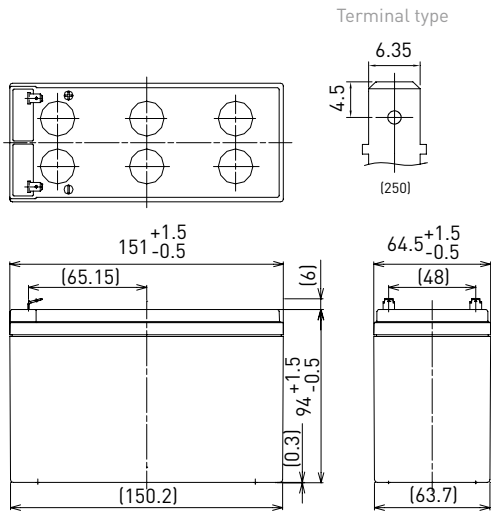

Specifications		UP-VW1236P1
Nominal voltage (V)		12
Rated power	10 minutes rate (W)	224
Nominal capacity	20 hours rate (Ah)	6.6
Dimensions	Length (mm)	64.5
	Width (mm)	151
	Total height (mm)	100
Approx. mass (kg)		2.05
Terminal type		Faston 250
Power (25°C)	30 minutes rate (W)	102
	15 minutes rate (W)	169
	10 minutes rate (W)	224
	5 minutes rate (W)	348
Impedance (mΩ)	Fully charged battery (25°C)	21
Temperature dependency of capacity (%) – 20 hours rate	40°C	102
	25°C	100
	0°C	85
	-15°C	65
Remaining capacity (25°C)	After 3 months (%)	91
	After 6 months (%)	82
	After 12 months (%)	64

DURATION OF DISCHARGE VS. DISCHARGE CURRENT

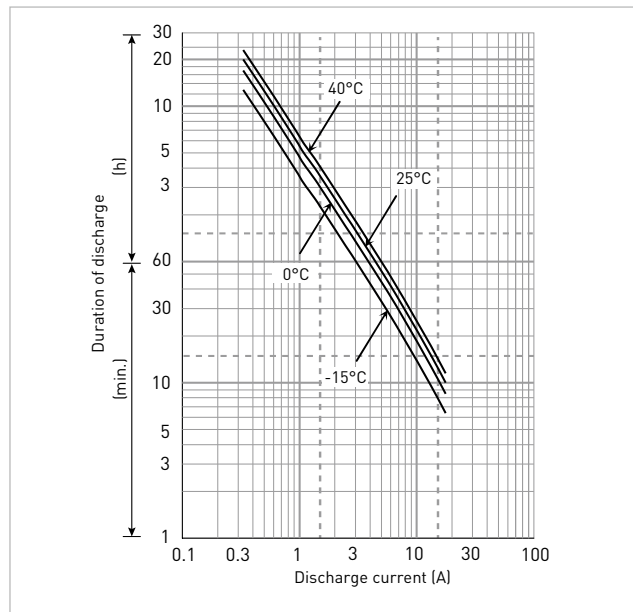

WATT TABLE (25°C)

(Wattage/battery)

Cut-off	3min.	5min.	10min.	15min.	20min.	30min.	45min.	1h	1.5h	2h	3h	4h	5h	6h	10h	20h
9.6V	461	348	224	169	140	102	73.3	58.3	44.1	34.5	24.3	18.6	15.1	12.7	7.60	4.02
9.9V	434	298	190	161	135	99.5	72.8	56.9	43.3	34.2	24.2	18.4	15.0	12.4	7.56	4.01
10.2V	406	283	185	153	131	97.4	69.8	55.3	41.0	32.3	23.1	18.1	14.4	12.1	7.24	3.87
10.5V	368	258	177	146	125	93.7	67.9	54.1	39.4	31.3	22.6	17.7	14.3	12.0	7.21	3.86
10.8V	331	232	167	140	120	90.1	63.6	50.0	36.8	27.9	21.0	16.4	13.1	11.1	6.72	3.61

AMPERE TABLE (25°C)

(Ampere/battery)

Cut-off	3min.	5min.	10min.	15min.	20min.	30min.	45min.	1h	1.5h	2h	3h	4h	5h	6h	10h	20h
9.6V	38.1	28.7	17.7	14.1	11.4	8.57	6.26	4.99	3.42	2.64	1.96	1.50	1.23	0.990	0.655	0.355
9.9V	35.9	27.4	17.3	13.4	11.0	8.39	6.22	4.85	3.35	2.62	1.95	1.49	1.22	0.986	0.652	0.354
10.2V	33.5	26.0	16.8	12.8	10.7	8.21	5.96	4.73	3.18	2.48	1.86	1.43	1.17	0.946	0.624	0.342
10.5V	30.4	23.7	16.0	12.2	10.23	7.91	5.80	4.63	3.05	2.40	1.82	1.37	1.10	0.936	0.622	0.330
10.8V	27.3	21.3	15.1	11.7	9.80	7.60	5.43	4.28	2.85	2.14	1.69	1.32	1.07	0.866	0.579	0.319

All mentioned values are average values

UP-VW1236P1

CHARGING METHOD (25°C)

Cycle use	Control voltage: 13.6V - 13.8V Initial current: 0.930A or smaller
------------------	--

CUT-OFF VOLTAGE

Discharge current	0.310A - 1.24A	1.24A - 3.10A	3.10A - 6.20A	6.20A - 12.4A	12.4A - 18.6A
Cut-off voltage	10.5V	10.2V	9.9V	9.3V	8.7V

INFLUENCE OF TEMPERATURE ON TRICKLE LIFE

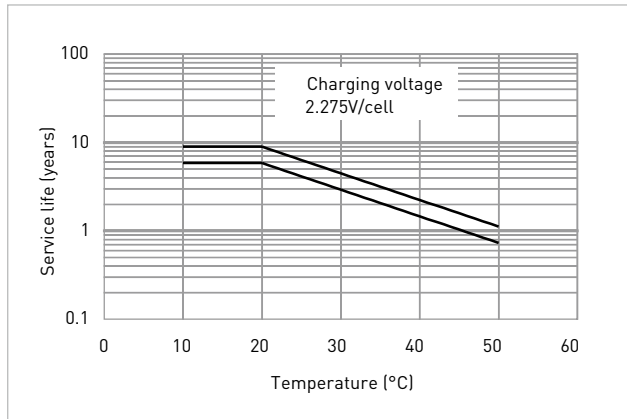

RESIDUAL CAPACITY TEST RESULT

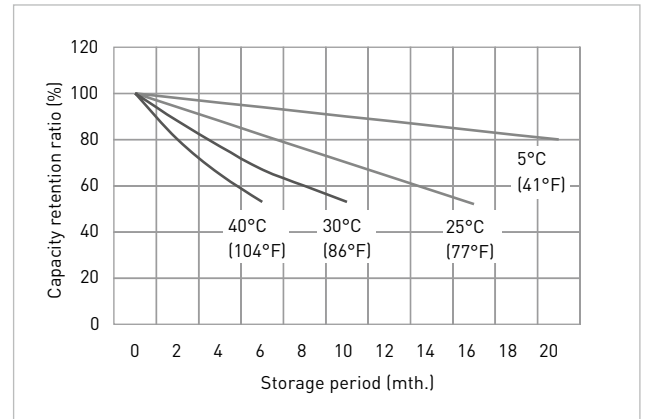

CONSTANT-VOLTAGE CONSTANT-CURRENT CHARGE CHARACTERISTICS FOR TRICKLE USE

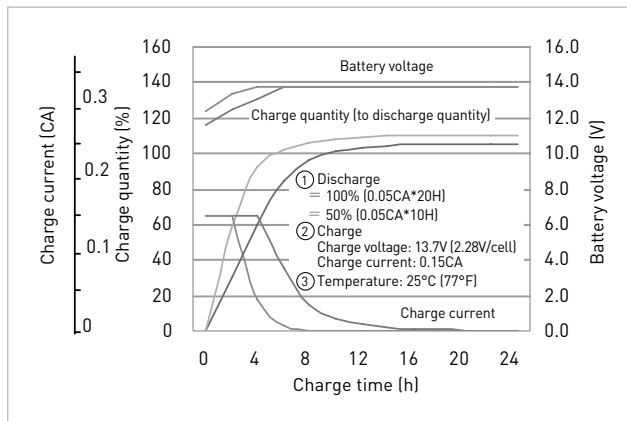

DISCHARGE CAPACITY BY TEMPERATURE AND BY DISCHARGE CURRENT

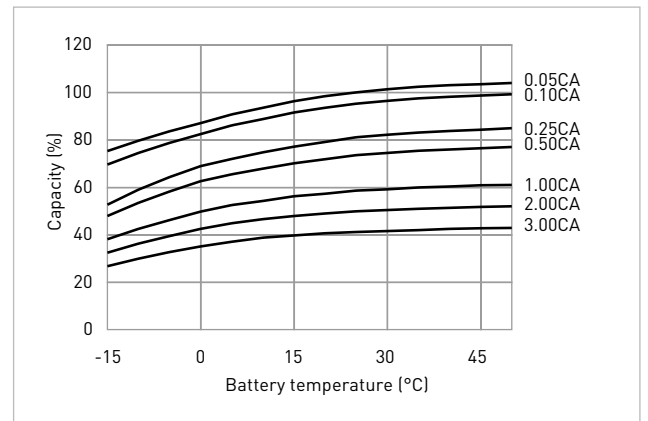

DISCHARGE CHARACTERISTICS

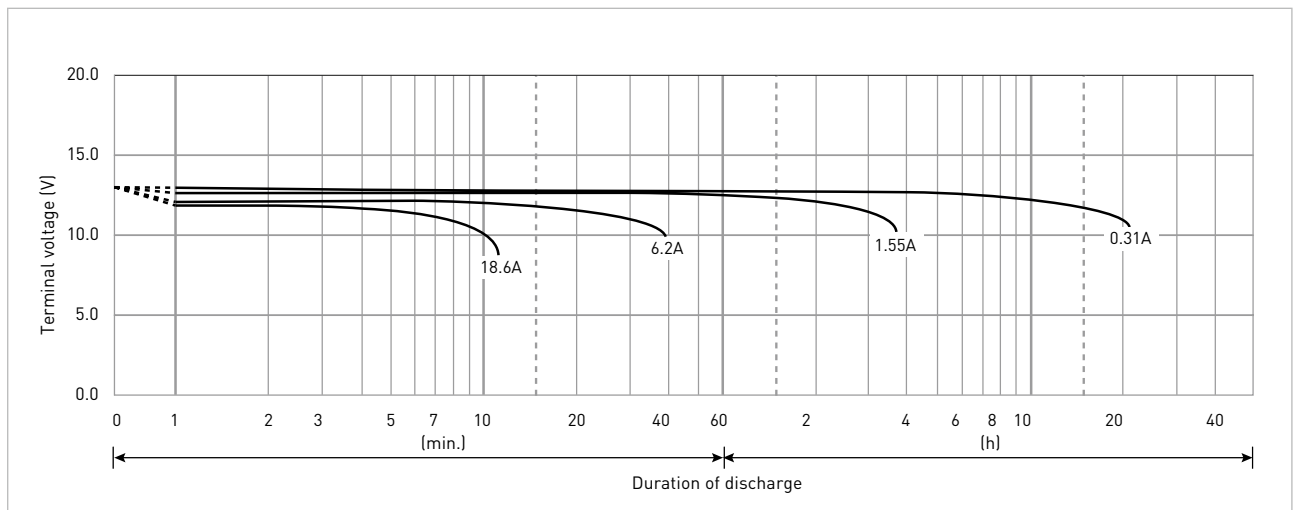

UP-VW1245P1

FOR STANDBY POWER SUPPLIES.
 EXPECTED TRICKLE DESIGN LIFE: 6 – 9 YEARS AT 20°C
 ACCORDING TO EUROBAT.

DIMENSIONS (MM)



Contents indicated (including the recycle marking, etc.) are subject to change without notice. Battery case resin: flame-retardant (UL94 V-0)

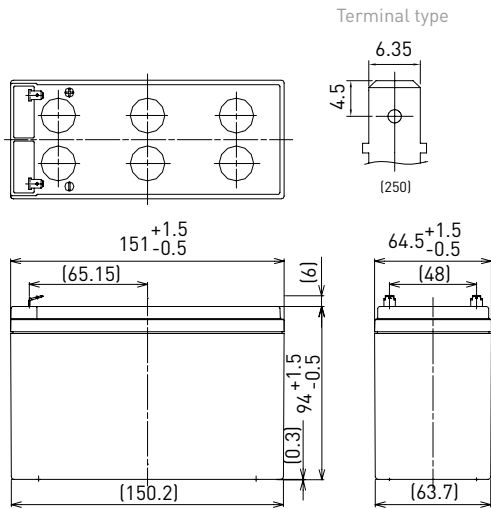

Specifications		UP-VW1245P1
Nominal voltage (V)		12
Rated power	10 minutes rate (W)	270
Nominal capacity	20 hours rate (Ah)	7.8
Dimensions	Length (mm)	64.5
	Width (mm)	151
	Total height (mm)	100
Approx. mass (kg)		2.55
Terminal type		Faston 250
Power (25°C)	30 minutes rate (W)	112
	15 minutes rate (W)	195
	10 minutes rate (W)	270
	5 minutes rate (W)	410
Impedance (mΩ)	Fully charged battery (25°C)	20
Temperature dependency of capacity (%) – 20 hours rate	40°C	102
	25°C	100
	0°C	85
	-15°C	65
Remaining capacity (25°C)	After 3 months (%)	91
	After 6 months (%)	82
	After 12 months (%)	64

DURATION OF DISCHARGE VS. DISCHARGE CURRENT

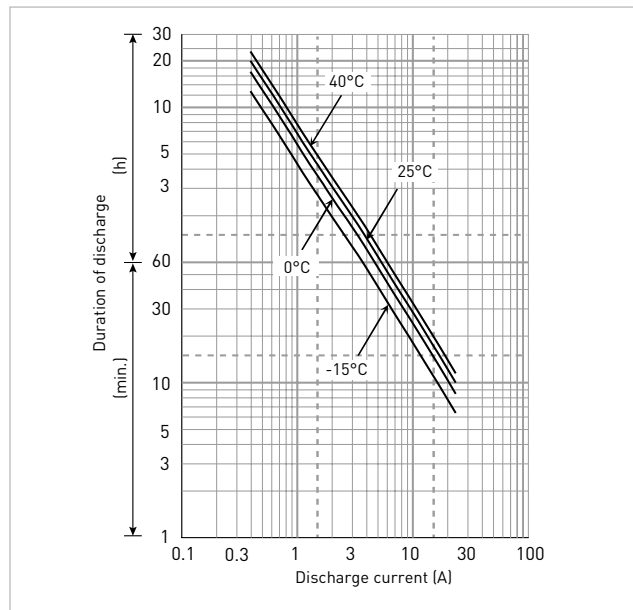

WATT TABLE (25°C)

(Wattage/battery)

Cut-off	3min.	5min.	10min.	15min.	20min.	30min.	45min.	1h	1.5h	2h	3h	4h	5h	6h	10h	20h
9.6V	530	410	270	195	159	112	82.1	65.7	45.2	34.9	26.0	20.0	16.5	13.3	8.79	4.76
9.9V	509	400	263	194	158	111	81.6	65.1	44.3	34.7	25.9	19.8	16.4	13.2	8.75	4.75
10.2V	490	390	258	193	156	110	80.8	64.4	43.4	33.9	25.6	19.7	16.2	13.1	8.65	4.73
10.5V	463	360	246	187	151	109	78.7	63.0	41.7	32.8	25.2	19.5	16.1	13.0	8.62	4.72
10.8V	434	330	234	180	146	108	78.3	61.8	41.3	31.1	24.7	19.3	15.7	12.7	8.52	4.69

AMPERE TABLE (25°C)

(Ampere/battery)

Cut-off	3min.	5min.	10min.	15min.	20min.	30min.	45min.	1h	1.5h	2h	3h	4h	5h	6h	10h	20h
9.6V	47.7	36.8	23.9	17.0	13.7	9.57	6.99	5.57	3.82	2.95	2.19	1.67	1.38	1.11	0.732	0.397
9.9V	45.8	35.9	23.5	16.9	13.6	9.55	6.95	5.50	3.75	2.93	2.17	1.66	1.37	1.10	0.729	0.396
10.2V	44.1	35.0	23.0	16.8	13.5	9.49	6.88	5.46	3.67	2.86	2.15	1.65	1.36	1.09	0.721	0.394
10.5V	41.6	32.3	22.0	16.3	13.0	9.40	6.70	5.35	3.53	2.77	2.11	1.64	1.35	1.08	0.718	0.393
10.8V	39.0	29.6	20.9	15.7	12.6	9.32	6.67	5.25	3.50	2.62	2.08	1.62	1.31	1.06	0.710	0.391

All mentioned values are average values

UP-VW1245P1

CHARGING METHOD (25°C)

Cycle use	Control voltage: 13.6V - 13.8V Initial current: 1.20A or smaller
------------------	---

CUT-OFF VOLTAGE

Discharge current	0.400A - 1.60A	1.60A - 4.00A	4.00A - 8.00A	8.00A - 16.0A	16.0A - 24.0A
Cut-off voltage	10.5V	10.2V	9.9V	9.3V	8.7V

INFLUENCE OF TEMPERATURE ON TRICKLE LIFE

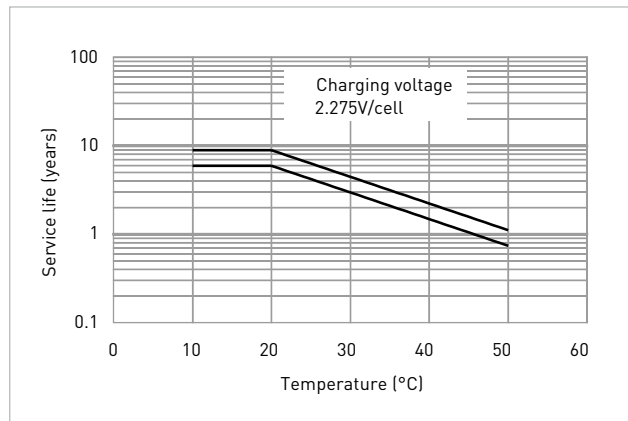

RESIDUAL CAPACITY TEST RESULT

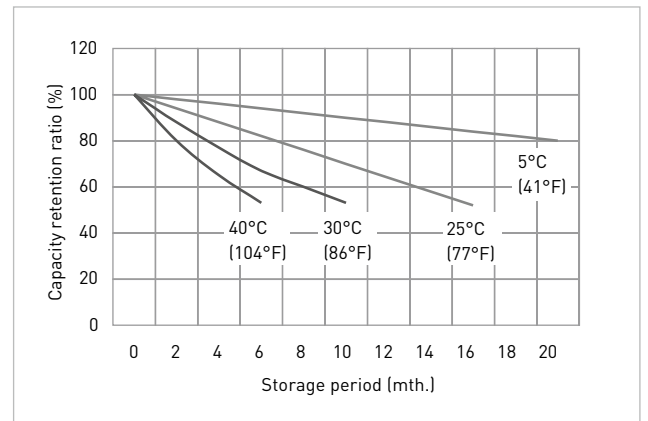

CONSTANT-VOLTAGE CONSTANT-CURRENT CHARGE CHARACTERISTICS FOR TRICKLE USE

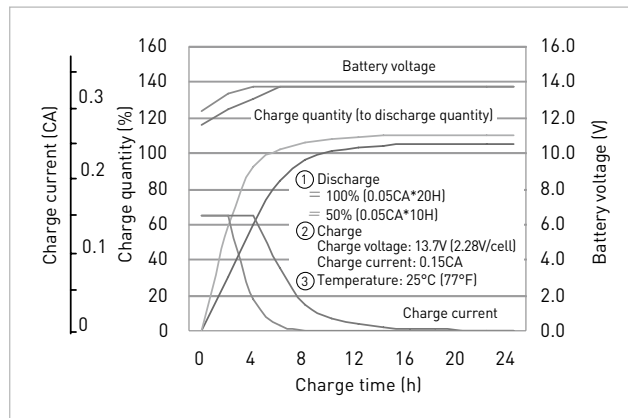

DISCHARGE CAPACITY BY TEMPERATURE AND BY DISCHARGE CURRENT

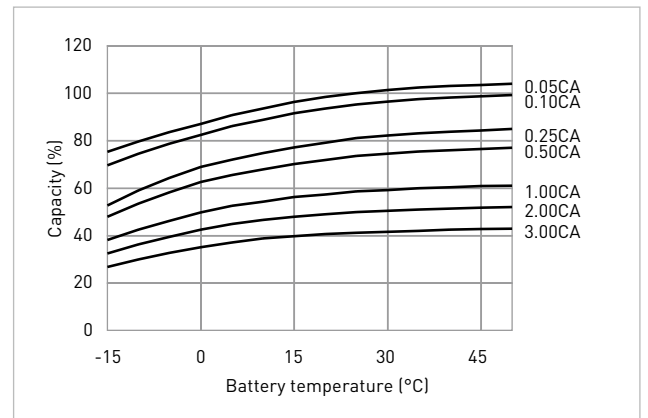

DISCHARGE CHARACTERISTICS

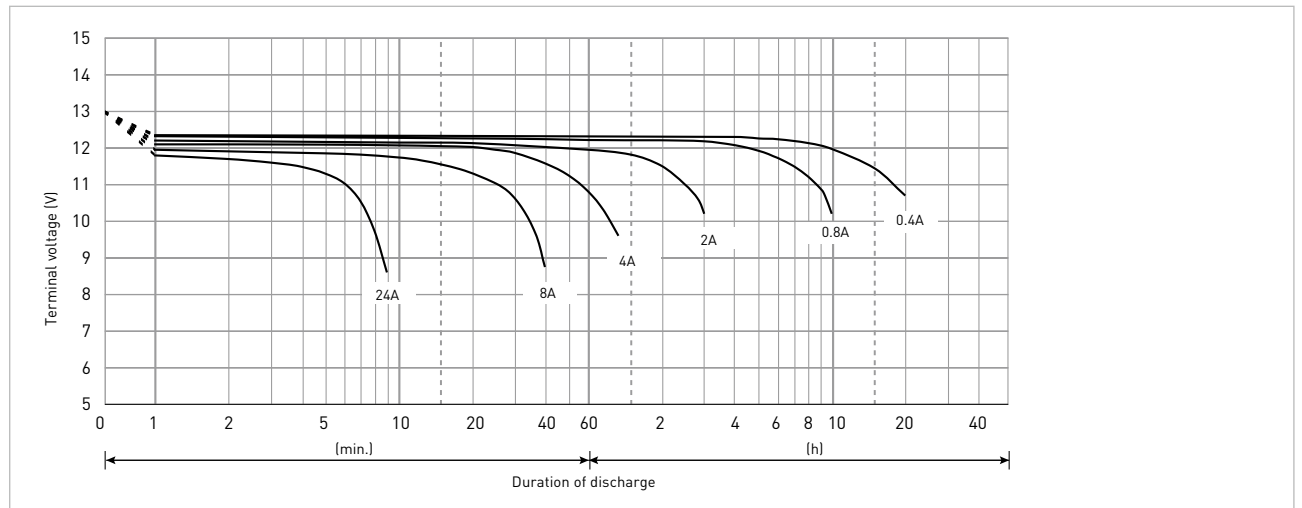

UP-PW1245P1

FOR STANDBY POWER SUPPLIES.
 EXPECTED TRICKLE DESIGN LIFE: 10 – 12 YEARS AT 20°C
 ACCORDING TO EUROBAT.

DIMENSIONS (MM)



Terminal type

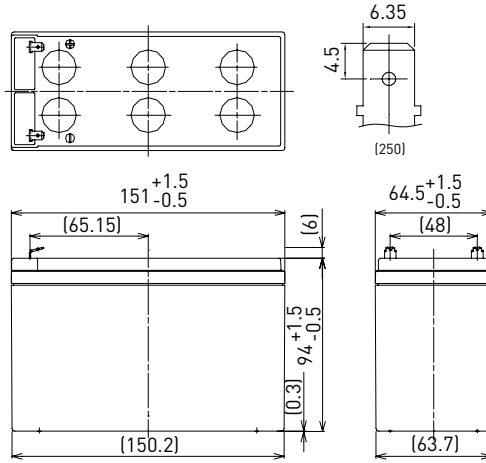

Contents indicated (including the recycle marking, etc.) are subject to change without notice. Battery case resin: flame-retardant (UL94 V-0)

Specifications		UP-PW1245P1
Nominal voltage (V)		12
Rated power	10 minutes rate (W)	270
Nominal capacity	20 hours rate (Ah)	7.8
Dimensions	Length (mm)	64.5
	Width (mm)	151
	Total height (mm)	100
Approx. mass (kg)		2.60
Terminal type		Faston 250
Power (25°C)	30 minutes rate (W)	112
	15 minutes rate (W)	195
	10 minutes rate (W)	270
	5 minutes rate (W)	410
Impedance (mΩ)	Fully charged battery (25°C)	20
Temperature dependency of capacity (%) – 20 hours rate	40°C	102
	25°C	100
	0°C	85
	-15°C	65
Remaining capacity (25°C)	After 3 months (%)	91
	After 6 months (%)	82
	After 12 months (%)	64

DURATION OF DISCHARGE VS. DISCHARGE CURRENT

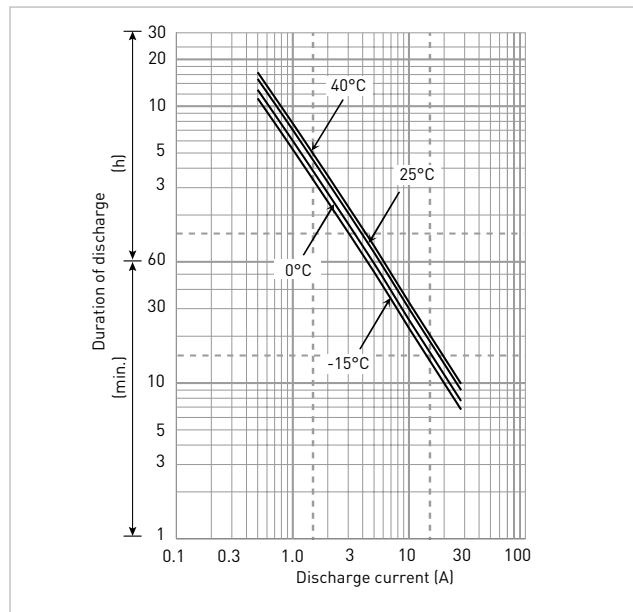

WATT TABLE (25°C)

(Wattage/battery)

Cut-off	3min.	5min.	10min.	15min.	20min.	30min.	45min.	1h	1.5h	2h	3h	4h	5h	6h	10h	20h
9.6V	530	410	270	195	159	112	82.1	65.7	45.2	34.9	26.0	20.0	16.5	13.3	8.79	4.76
9.9V	509	400	263	194	158	111	81.6	65.1	44.3	34.7	25.9	19.8	16.4	13.2	8.75	4.75
10.2V	490	390	258	193	156	110	80.8	64.4	43.4	33.9	25.6	19.7	16.2	13.1	8.65	4.73
10.5V	463	360	246	187	151	109	78.7	63.0	41.7	32.8	25.2	19.5	16.1	13.0	8.62	4.72
10.8V	434	330	234	180	146	108	78.3	61.8	41.3	31.1	24.7	19.3	15.7	12.7	8.52	4.69

AMPERE TABLE (25°C)

(Ampere/battery)

Cut-off	3min.	5min.	10min.	15min.	20min.	30min.	45min.	1h	1.5h	2h	3h	4h	5h	6h	10h	20h
9.6V	47.7	36.8	23.9	17.0	13.7	9.57	6.99	5.57	3.82	2.95	2.19	1.67	1.38	1.11	0.732	0.397
9.9V	45.8	35.9	23.5	16.9	13.6	9.55	6.95	5.50	3.75	2.93	2.17	1.66	1.37	1.10	0.729	0.396
10.2V	44.1	35.0	23.0	16.8	13.5	9.49	6.88	5.46	3.67	2.86	2.15	1.65	1.36	1.09	0.721	0.394
10.5V	41.6	32.3	22.0	16.3	13.0	9.40	6.70	5.35	3.53	2.77	2.11	1.64	1.35	1.08	0.718	0.393
10.8V	39.0	29.6	20.9	15.7	12.6	9.32	6.67	5.25	3.50	2.62	2.08	1.62	1.31	1.06	0.710	0.391

All mentioned values are average values

UP-PW1245P1

CHARGING METHOD (25°C)

Cycle use	Control voltage: 13.6V - 13.8V Initial current: 1.2A or smaller
------------------	--

CUT-OFF VOLTAGE

Discharge current	0.4A - 1.6A	1.6A - 4A	4A - 8A	8A - 16A	16A - 24A
Cut-off voltage	10.5V	10.2V	9.9V	9.3V	8.7V

INFLUENCE OF TEMPERATURE ON TRICKLE LIFE

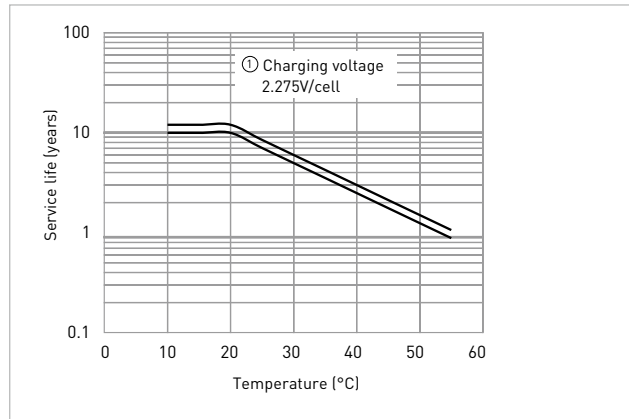

RESIDUAL CAPACITY TEST RESULT

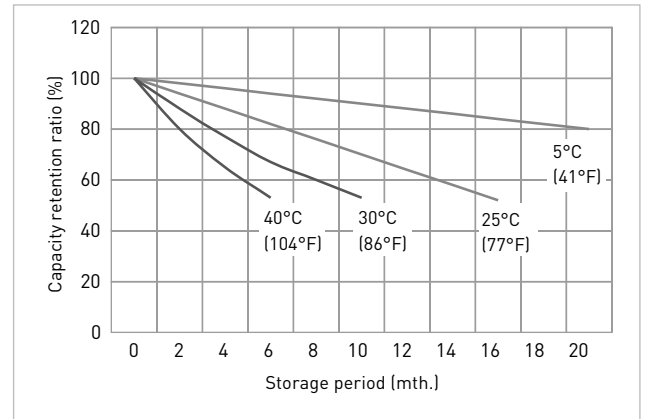

CONSTANT-VOLTAGE CONSTANT-CURRENT CHARGE CHARACTERISTICS FOR TRICKLE USE

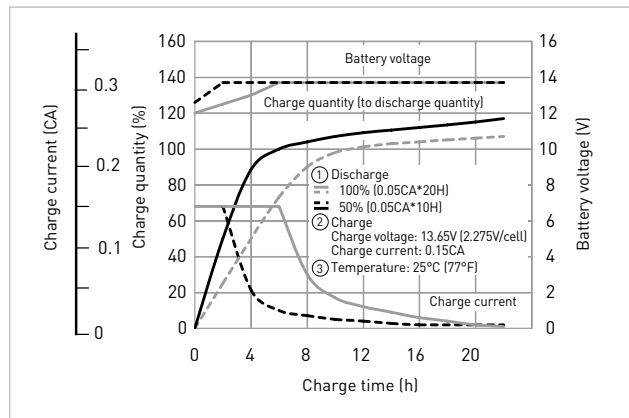

DISCHARGE CAPACITY BY TEMPERATURE AND BY DISCHARGE CURRENT

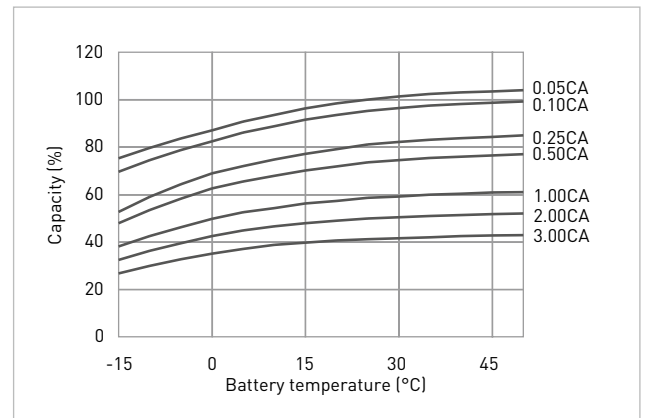

DISCHARGE CHARACTERISTICS

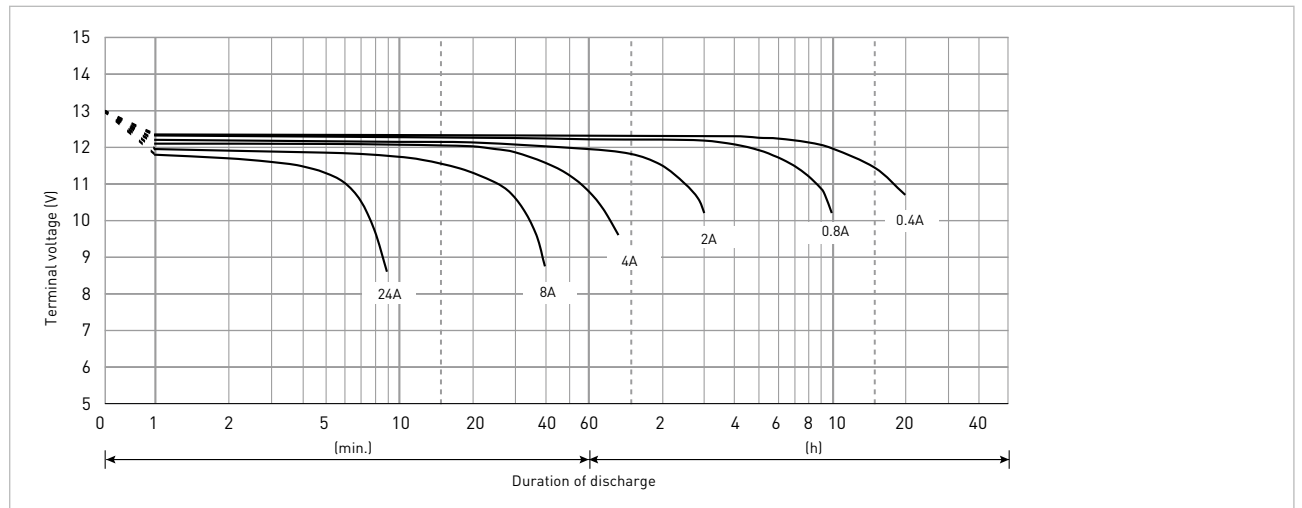

LC-CA1212P/P1

FOR MAIN POWER SUPPLIES.
CYCLE LONG-LIFE TYPE

DIMENSIONS (MM)



Contents indicated (including the recycle marking, etc.) are subject to change without notice. Battery case resin: standard (UL94 HB)

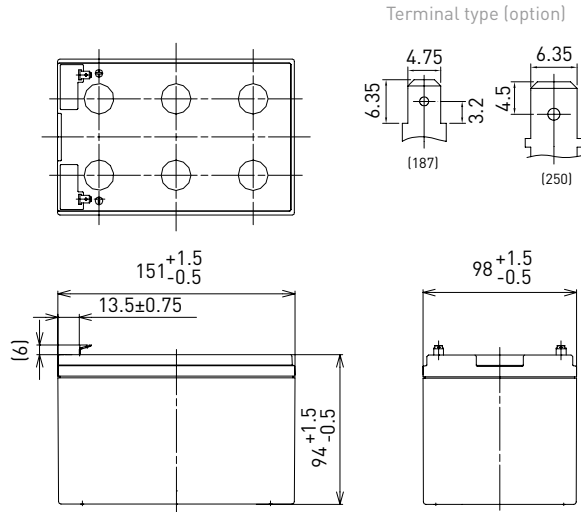

Specifications		LC-CA1212P/P1
Nominal voltage (V)		12
Nominal capacity	20 hours rate (Ah)	12.0
Dimensions	Length (mm)	98
	Width (mm)	151
	Total height (mm)	100
Approx. mass (kg)		3.80
Terminal type		Faston 187/250
Capacity (25°C)	20 hours rate (Ah)	12.0
	10 hours rate (Ah)	11.0
	3 hours rate (Ah)	9.3
	1 hour rate (Ah)	8.5
Impedance (mΩ)	Fully charged battery (25°C)	15
	40°C	102
Temperature dependency of capacity (%) - 20 hours rate	25°C	100
	0°C	85
	-15°C	65
	Remaining capacity (25°C)	
After 3 months (%)		91
After 6 months (%)		82
After 12 months (%)		64

DURATION OF DISCHARGE VS. DISCHARGE CURRENT

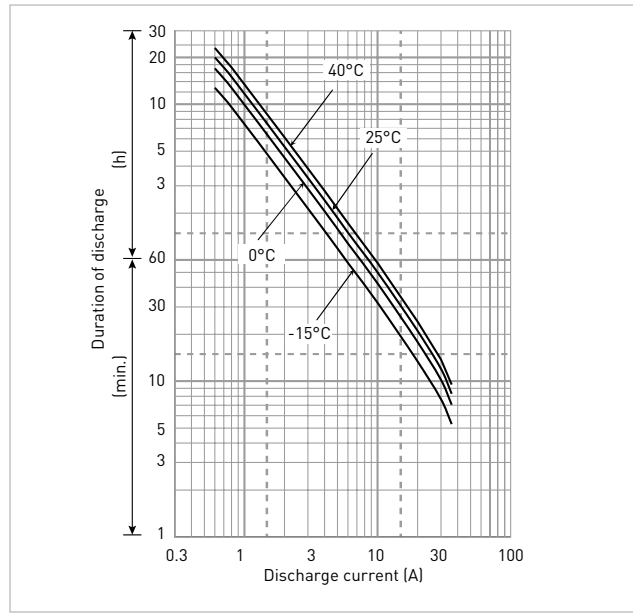

WATT TABLE (25°C)

(Wattage/battery)

Cut-off	3min.	5min.	10min.	15min.	20min.	30min.	45min.	1h	1.5h	2h	3h	4h	5h	6h	10h	20h
9.6V	679	559	384	298	247	183	137	105	70.3	54.5	38.1	28.8	24.1	21.7	13.3	7.22
9.9V	649	537	373	288	241	177	135	104	69.9	54.2	37.8	28.8	24.1	21.7	13.3	7.22
10.2V	607	506	363	282	235	177	134	102	69.1	53.9	37.5	28.8	24.0	21.6	13.2	7.21
10.5V	556	475	343	271	231	172	133	100	68.5	53.3	36.9	28.7	24.0	21.6	13.2	7.20
10.8V	495	434	321	261	225	166	123	98	66.1	52.1	36.3	28.4	23.8	21.5	13.1	7.18

AMPERE TABLE (25°C)

(Ampere/battery)

Cut-off	3min.	5min.	10min.	15min.	20min.	30min.	45min.	1h	1.5h	2h	3h	4h	5h	6h	10h	20h
9.6V	61.1	50.1	34.3	25.9	21.3	15.6	11.7	8.90	5.95	4.60	3.20	2.41	2.01	1.81	1.11	0.602
9.9V	58.4	48.2	33.3	25.0	20.8	15.1	11.5	8.80	5.92	4.58	3.18	2.41	2.01	1.81	1.11	0.602
10.2V	54.6	45.4	32.4	24.5	20.3	15.1	11.4	8.70	5.85	4.55	3.15	2.41	2.00	1.80	1.10	0.601
10.5V	50.0	42.6	30.6	23.6	19.9	14.7	11.3	8.50	5.80	4.50	3.10	2.40	2.00	1.80	1.10	0.600
10.8V	44.5	38.9	28.7	22.7	19.4	14.2	10.5	8.30	5.60	4.40	3.05	2.38	1.99	1.79	1.09	0.598

All mentioned values are average values

LC-CA1212P/P1

CHARGING METHOD (25°C)

Cycle use	Control voltage 14.5V - 14.9V Initial current 4.8A or smaller
------------------	--

CUT-OFF VOLTAGE

Discharge current	0.6A - 2.4A	2.4A - 6A	6A - 12A	12A - 24A	24A - 36A
Cut-off voltage	10.5V	10.2V	9.9V	9.3V	8.7V

CYCLE LIFE VS. DEPTH OF DISCHARGE (ACC. IEC 61056)

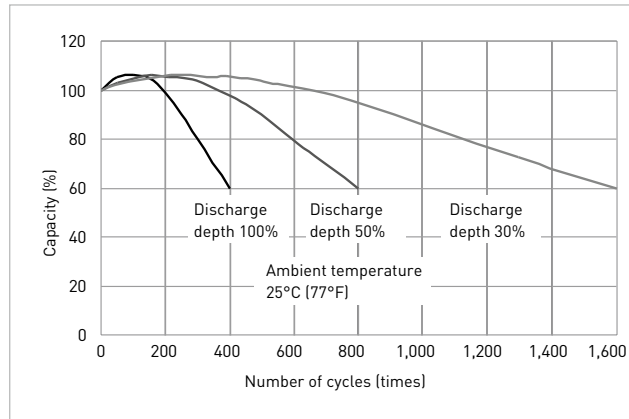

RESIDUAL CAPACITY TEST RESULT

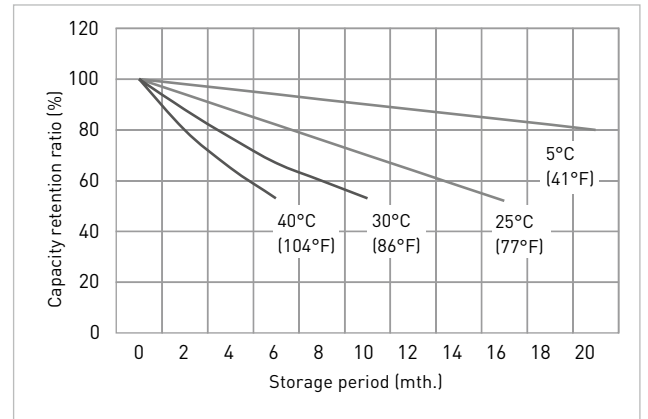

CONSTANT-VOLTAGE CONSTANT-CURRENT CHARGE CHARACTERISTICS FOR CYCLE USE

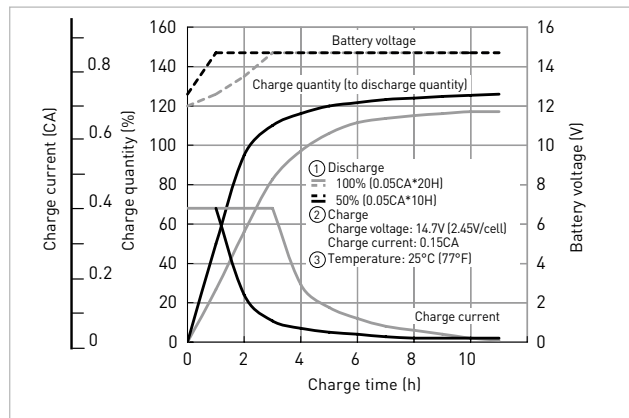

DISCHARGE CAPACITY BY TEMPERATURE AND BY DISCHARGE CURRENT

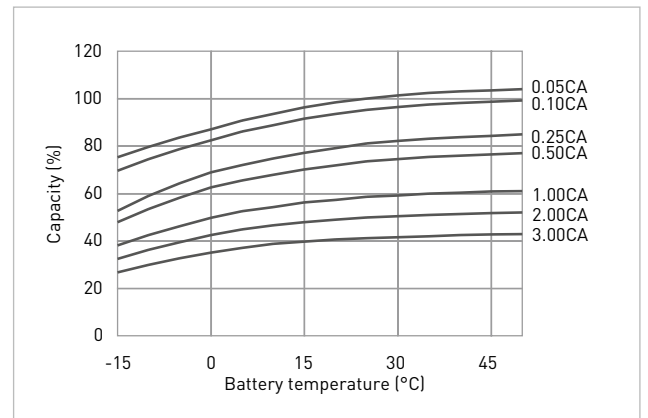

DISCHARGE CHARACTERISTICS

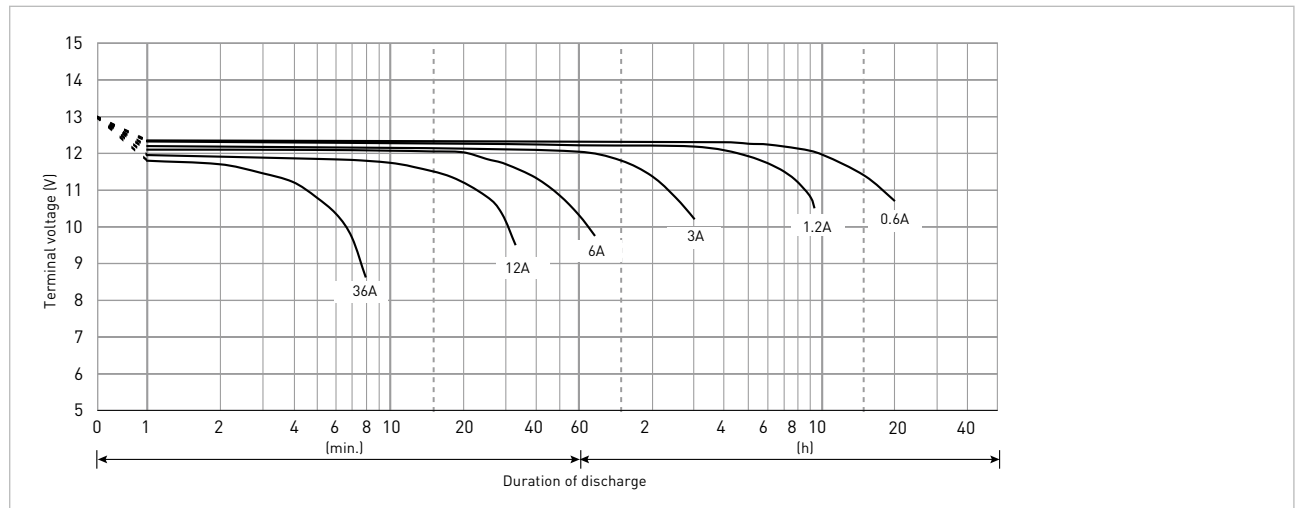

LC-CA1215P/P1

FOR MAIN POWER SUPPLIES.
CYCLE LONG-LIFE TYPE

DIMENSIONS (MM)



Contents indicated (including the recycle marking, etc.) are subject to change without notice. Battery case resin: standard (UL94 HB)

Terminal type (option)

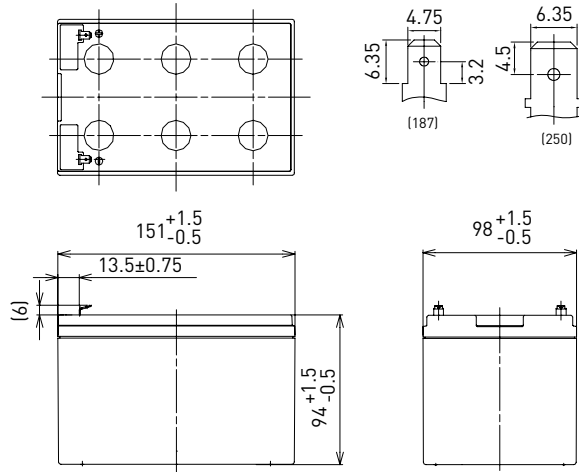

Specifications		LC-CA1215P/P1
Nominal voltage (V)		12
Nominal capacity 20 hours rate (Ah)		15.0
Dimensions	Length (mm)	98
	Width (mm)	151
	Total height (mm)	100
Approx. mass (kg)		4.20
Terminal type		Faston 187/250
Capacity (25°C)	20 hours rate (Ah)	15.0
	10 hours rate (Ah)	13.0
	3 hours rate (Ah)	12.0
	1 hour rate (Ah)	10.0
Impedance (mΩ) Fully charged battery (25°C)		15
Temperature dependency of capacity (%) - 20 hours rate	40°C	102
	25°C	100
	0°C	85
	-15°C	65
Remaining capacity (25°C)	After 3 months (%)	91
	After 6 months (%)	82
	After 12 months (%)	64

DURATION OF DISCHARGE VS. DISCHARGE CURRENT

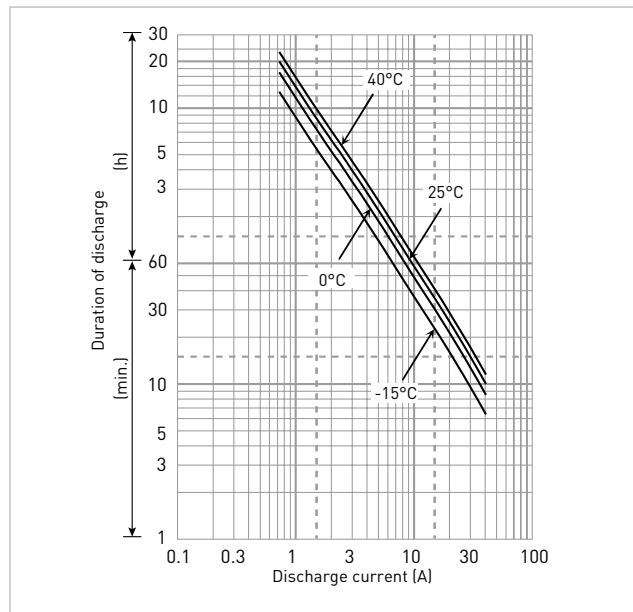

WATT TABLE (25°C)

(Wattage/battery)

Cut-off	3min.	5min.	10min.	15min.	20min.	30min.	45min.	1h	1.5h	2h	3h	4h	5h	6h	10h	20h
9.6V	850	682	455	350	292	217	157	123	83.9	65.0	47.1	36.0	29.9	25.2	16.2	8.75
9.9V	799	646	444	343	286	213	156	122	82.8	64.6	46.9	35.8	29.7	25.1	16.1	8.74
10.2V	741	607	433	336	281	211	154	121	81.4	63.4	46.4	35.7	29.5	24.9	15.9	8.72
10.5V	667	555	404	318	270	206	152	118	80.1	61.9	45.7	35.5	29.4	24.8	15.8	8.70
10.8V	576	497	368	300	263	199	146	116	77.7	59.6	44.8	35.1	28.9	24.5	15.7	8.66

AMPERE TABLE (25°C)

(Ampere/battery)

Cut-off	3min.	5min.	10min.	15min.	20min.	30min.	45min.	1h	1.5h	2h	3h	4h	5h	6h	10h	20h
9.6V	76.5	61.2	40.6	30.4	25.2	18.5	13.4	10.5	7.11	5.49	3.96	3.01	2.49	2.10	1.35	0.755
9.9V	71.8	58.0	39.7	29.9	24.7	18.2	13.3	10.4	7.01	5.45	3.94	3.00	2.48	2.09	1.34	0.753
10.2V	66.6	54.5	38.6	29.2	24.2	18.1	13.1	10.3	6.89	5.36	3.90	2.99	2.46	2.08	1.33	0.752
10.5V	59.9	49.8	36.1	27.6	23.3	17.6	13.0	10.0	6.78	5.22	3.84	2.97	2.45	2.07	1.32	0.750
10.8V	51.8	44.6	32.9	26.1	22.7	17.0	12.5	9.82	6.58	5.03	3.77	2.94	2.41	2.04	1.31	0.747

All mentioned values are average values

LC-CA1215P/P1

CHARGING METHOD (25°C)

Cycle use	Control voltage: 14.5V - 14.9V Initial current: 6.00A or smaller
------------------	---

CUT-OFF VOLTAGE

Discharge current	0.750A - 3.00A	3.00A - 7.50A	7.50A - 15.0A	15.0A - 30.0A	30.0A - 45.0A
Cut-off voltage	10.5V	10.2V	9.9V	9.3V	8.7V

CYCLE LIFE VS. DEPTH OF DISCHARGE (ACC. IEC 61056)

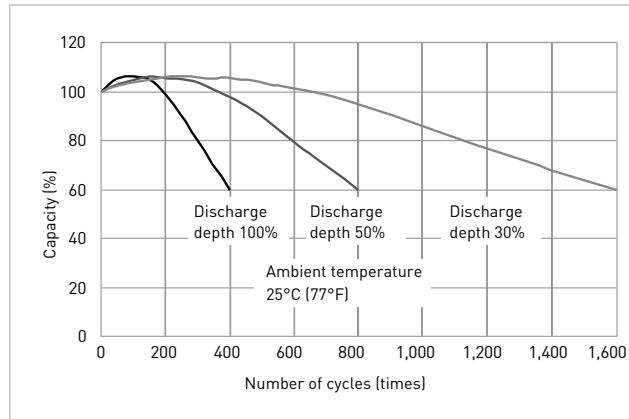

RESIDUAL CAPACITY TEST RESULT

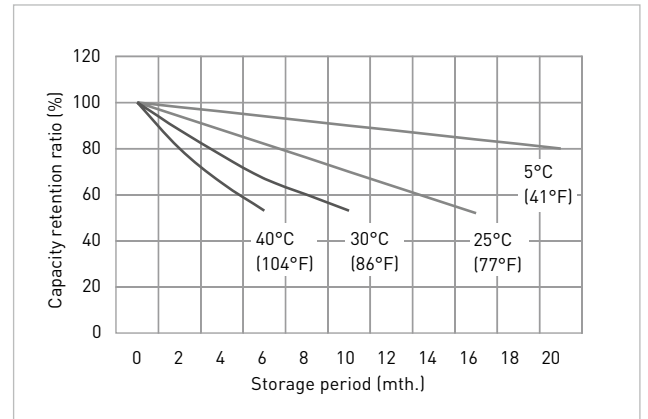

CONSTANT-VOLTAGE CONSTANT-CURRENT CHARGE CHARACTERISTICS FOR CYCLE USE

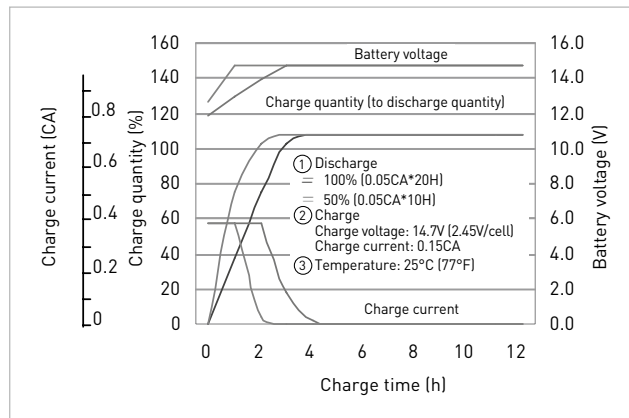

DISCHARGE CAPACITY BY TEMPERATURE AND BY DISCHARGE CURRENT

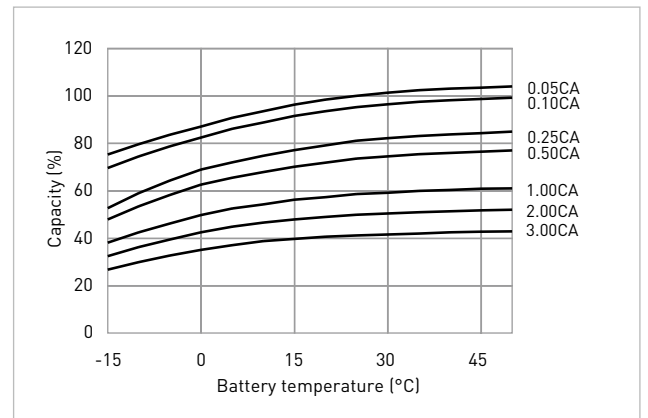

DISCHARGE CHARACTERISTICS

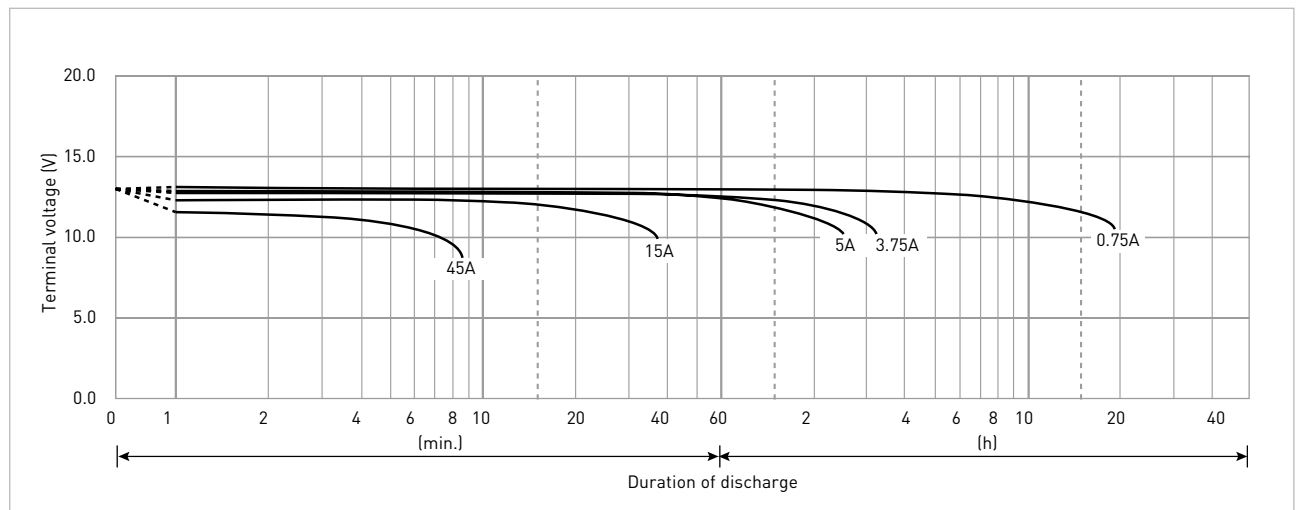

LC-CA1216P/P1

FOR MAIN POWER SUPPLIES.
CYCLE LONG-LIFE TYPE

DIMENSIONS (MM)



Terminal type (option)

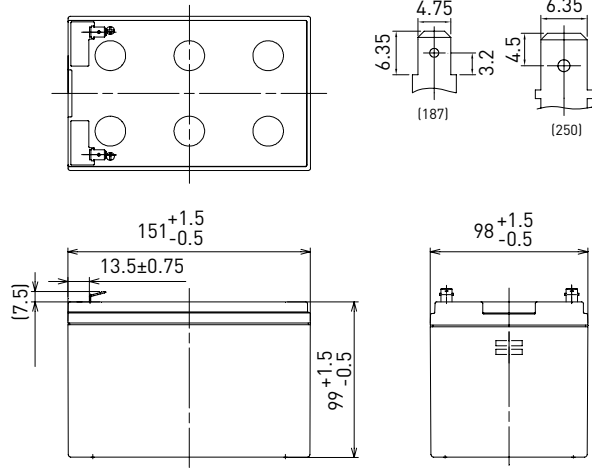

Contents indicated (including the recycle marking, etc.) are subject to change without notice. Battery case resin: standard (UL94 HB)

Specifications		LC-CA1216P/P1
Nominal voltage (V)		12
Nominal capacity		20 hours rate (Ah) 16.0
Dimensions	Length (mm)	98
	Width (mm)	151
	Total height (mm)	105
Approx. mass (kg)		4.70
Terminal type		Faston 187/250
Capacity (25°C)	20 hours rate (Ah)	16.0
	10 hours rate (Ah)	15.0
	3 hours rate (Ah)	13.0
	1 hour rate (Ah)	11.0
Impedance (mΩ)	Fully charged battery (25°C)	11
	Temperature dependency of capacity (%) - 20 hours rate	
	40°C	102
	25°C	100
	0°C	85
	-15°C	65
Remaining capacity (25°C)	After 3 months (%)	91
	After 6 months (%)	82
	After 12 months (%)	64

DURATION OF DISCHARGE VS. DISCHARGE CURRENT

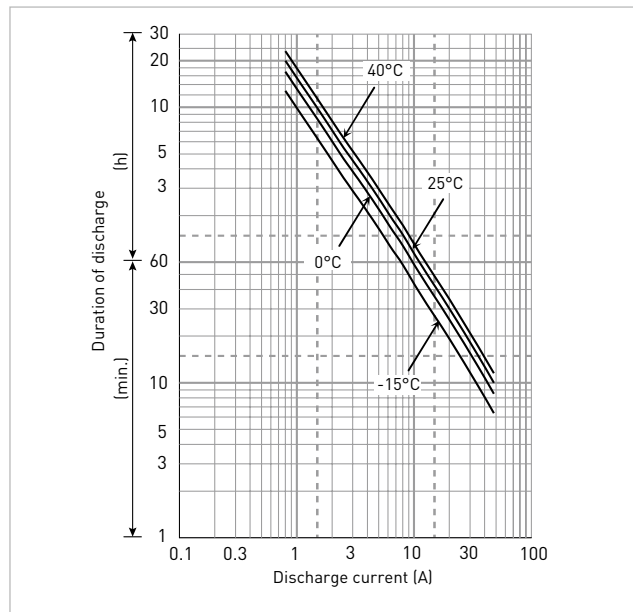

WATT TABLE (25°C)

(Wattage/battery)

Cut-off	3min.	5min.	10min.	15min.	20min.	30min.	45min.	1h	1.5h	2h	3h	4h	5h	6h	10h	20h
9.6V	879	721	517	381	308	225	165	132	94.2	74.7	53.1	40.5	33.0	28.1	17.8	9.54
9.9V	825	683	505	374	302	220	163	131	92.9	74.2	52.8	40.4	32.9	28.0	17.8	9.52
10.2V	766	642	491	366	296	219	162	129	91.3	72.9	52.3	40.2	32.7	27.8	17.6	9.50
10.5V	689	586	459	346	285	213	160	126	89.9	71.1	51.5	40.0	32.5	27.6	17.5	9.48
10.8V	595	526	418	327	277	206	153	123	87.2	68.5	50.6	39.5	32.0	27.3	17.4	9.43

AMPERE TABLE (25°C)

(Ampere/battery)

Cut-off	3min.	5min.	10min.	15min.	20min.	30min.	45min.	1h	1.5h	2h	3h	4h	5h	6h	10h	20h
9.6V	83.3	68.7	48.0	35.0	28.1	20.5	14.9	11.6	8.07	6.70	4.64	3.47	2.84	2.35	1.51	0.800
9.9V	77.3	64.4	46.9	34.3	27.6	20.1	14.8	11.5	7.96	6.66	4.61	3.45	2.83	2.34	1.50	0.800
10.2V	71.4	60.4	45.6	33.6	27.0	19.9	14.6	11.3	7.83	6.54	4.57	3.44	2.81	2.33	1.49	0.800
10.5V	63.4	54.1	42.6	31.8	26.0	19.5	14.5	11.1	7.71	6.38	4.49	3.42	2.80	2.32	1.48	0.800
10.8V	53.6	47.8	38.8	30.0	25.3	18.8	13.9	10.8	7.47	6.15	4.41	3.38	2.75	2.29	1.47	0.800

All mentioned values are average values

LC-CA1216P/P1

CHARGING METHOD (25°C)

Cycle use	Control voltage: 14.5V - 14.9V Initial current: 6.40A or smaller
------------------	---

CUT-OFF VOLTAGE

Discharge current	0.800A - 3.20A	3.20A - 8.00A	8.00A - 16.0A	16.0A - 32.0A	32.0A - 48.0A
Cut-off voltage	10.5V	10.2V	9.9V	9.3V	8.7V

CYCLE LIFE VS. DEPTH OF DISCHARGE (ACC. IEC 61056)

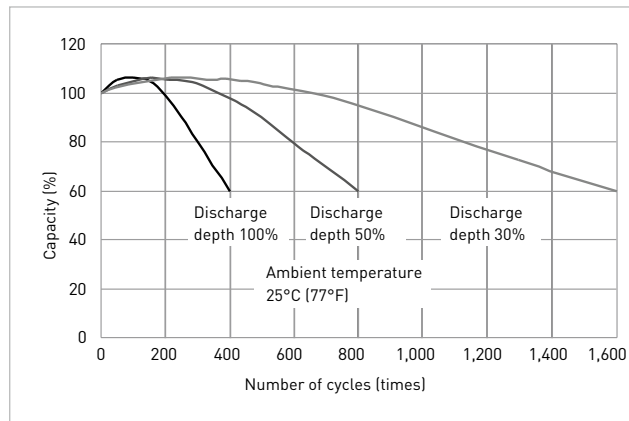

RESIDUAL CAPACITY TEST RESULT

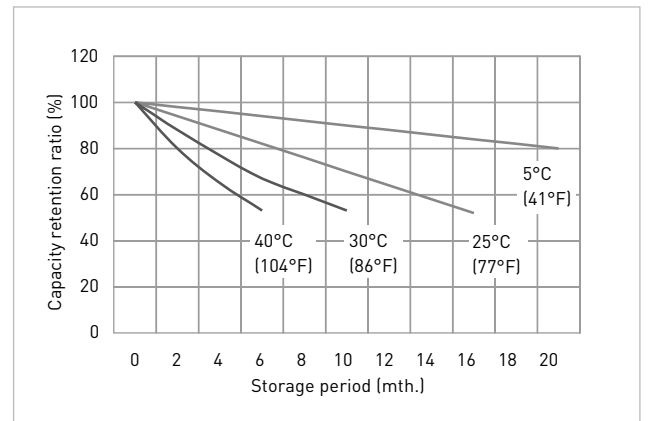

CONSTANT-VOLTAGE CONSTANT-CURRENT CHARGE CHARACTERISTICS FOR CYCLE USE

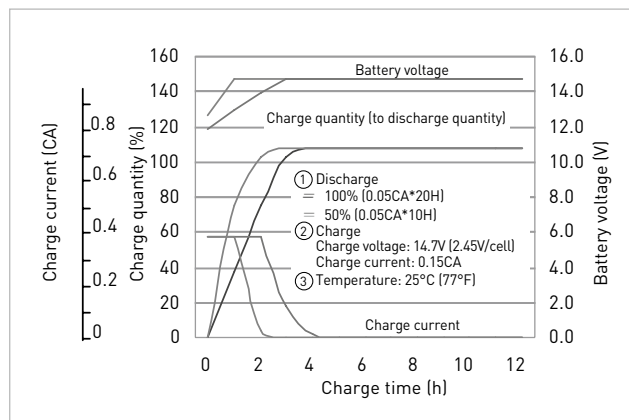

DISCHARGE CAPACITY BY TEMPERATURE AND BY DISCHARGE CURRENT

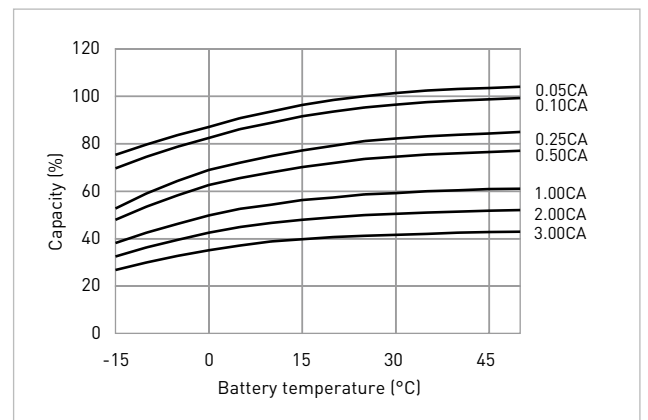

DISCHARGE CHARACTERISTICS

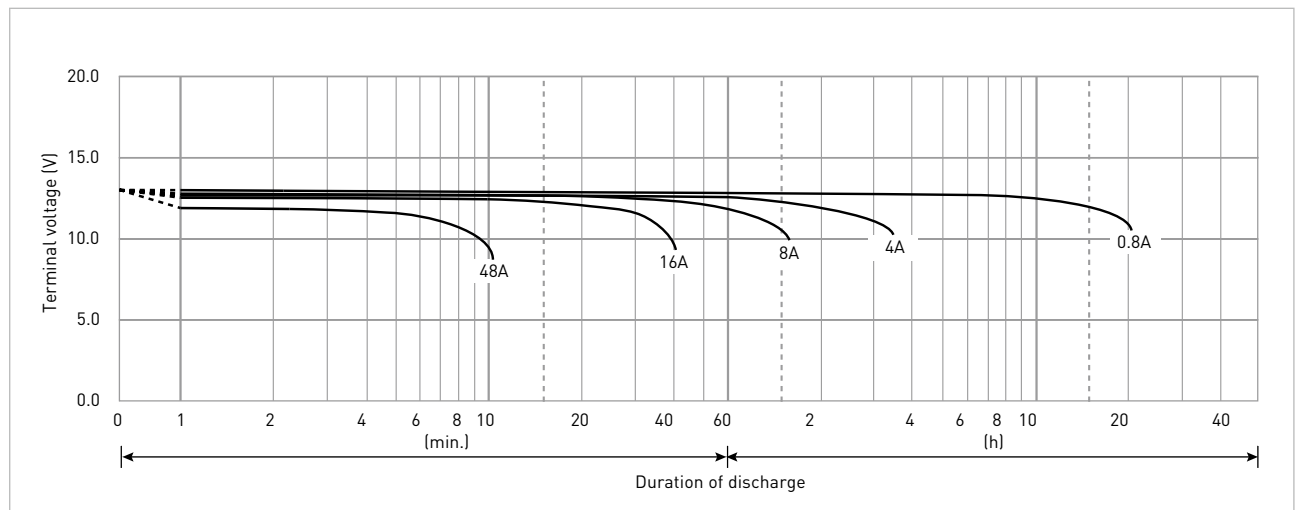

LC-XC1222P/AP

FOR MAIN POWER SUPPLIES.
CYCLE LONG-LIFE TYPE

DIMENSIONS (MM)



Terminal type (option)

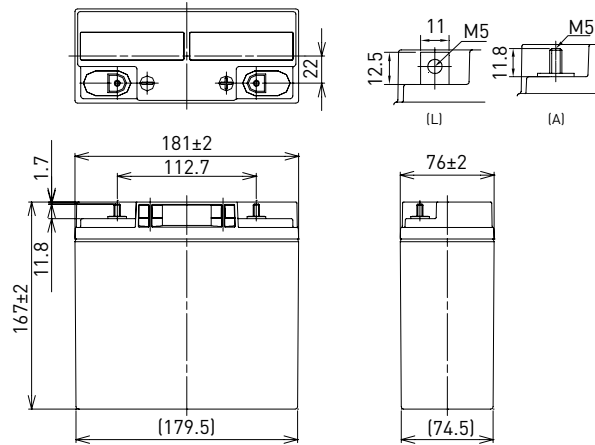

Contents indicated (including the recycle marking, etc.) are subject to change without notice. Battery case resin: standard (UL94 HB)

Specifications		LC-XC1222P/AP
Nominal voltage (V)		12
Nominal capacity	20 hours rate (Ah)	22.0
Dimensions	Length (mm)	76
	Width (mm)	181
	Total height (mm)	167
Approx. mass (kg)		6.55
Terminal type		M5 bolt/nut & threaded post
Capacity (25°C)	20 hours rate (Ah)	22.0
	10 hours rate (Ah)	20.0
	3 hours rate (Ah)	17.0
	1 hour rate (Ah)	14.0
Impedance (mΩ)	Fully charged battery (25°C)	12
	Temperature dependency of capacity (%) - 20 hours rate	
	40°C	102
	25°C	100
	0°C	85
	-15°C	65
Remaining capacity (25°C)	After 3 months (%)	91
	After 6 months (%)	82
	After 12 months (%)	64

DURATION OF DISCHARGE VS. DISCHARGE CURRENT

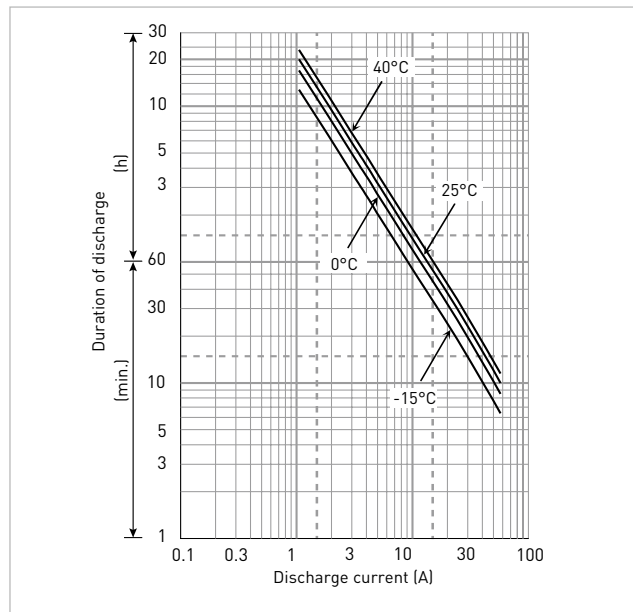

WATT TABLE (25°C)

(Wattage/battery)

Cut-off	5min.	10min.	15min.	20min.	30min.	45min.	1h	1.5h	2h	3h	4h	5h	6h	10h	20h
9.6V	803	618	472	396	295	213	172	117	93.2	69.4	53.3	44.0	35.4	24.0	13.0
9.9V	787	605	469	389	292	211	170	115	92.5	69.0	53.0	43.7	35.2	23.9	13.0
10.2V	767	590	459	383	289	209	167	112	90.1	68.3	52.6	43.3	35.0	23.6	12.9
10.5V	710	546	427	363	282	206	163	110	87.0	67.3	52.3	43.0	34.5	23.5	12.9
10.8V	633	487	399	354	272	203	160	107	82.8	65.9	51.6	41.9	34.0	23.3	12.8

AMPERE TABLE (25°C)

(Ampere/battery)

Cut-off	5min.	10min.	15min.	20min.	30min.	45min.	1h	1.5h	2h	3h	4h	5h	6h	10h	20h
9.6V	77.2	59.4	43.0	36.7	25.4	18.8	14.9	9.79	7.55	5.85	4.48	3.69	2.96	2.04	1.11
9.9V	75.7	58.2	42.7	36.1	25.1	18.7	14.5	9.59	7.49	5.82	4.45	3.66	2.95	2.04	1.11
10.2V	73.7	56.7	41.8	35.5	24.8	18.5	14.2	9.40	7.30	5.76	4.42	3.63	2.93	2.02	1.10
10.5V	68.4	52.6	38.9	33.7	24.3	18.2	13.9	9.20	7.05	5.58	4.39	3.60	2.89	2.01	1.10
10.8V	61.0	46.9	36.3	32.8	23.4	17.9	13.6	8.95	6.71	5.56	4.33	3.51	2.84	1.99	1.09

All mentioned values are average values

LC-XC1222P/AP

CHARGING METHOD (25°C)

Cycle use	Control voltage: 14.5V - 14.9V Initial current: 8.80A or smaller
------------------	---

CUT-OFF VOLTAGE

Discharge current	1.10A - 5.50A	5.50A - 11.0A	11.0A - 22.0A	22.0A - 44.0A	44.0A - 66.0A
Cut-off voltage	10.5V	10.2V	9.9V	9.3V	8.7V

CYCLE LIFE VS. DEPTH OF DISCHARGE (ACC. IEC 61056)

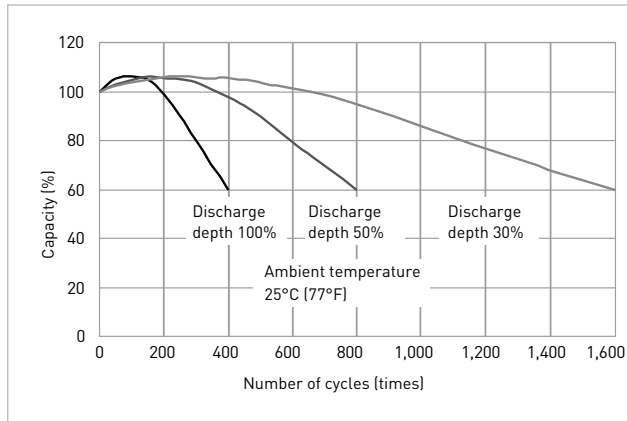

RESIDUAL CAPACITY TEST RESULT

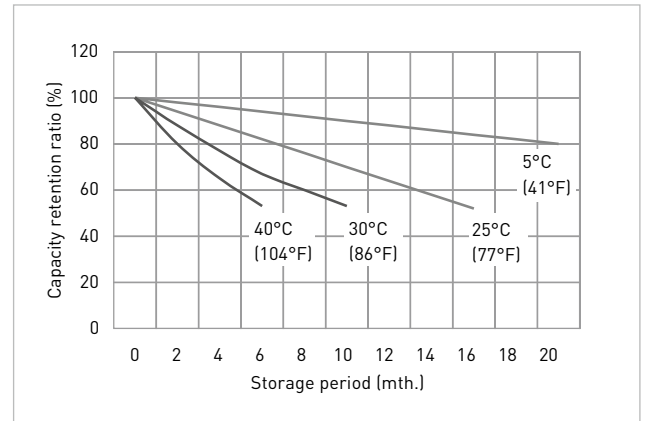

CONSTANT-VOLTAGE CONSTANT-CURRENT CHARGE CHARACTERISTICS FOR CYCLE USE

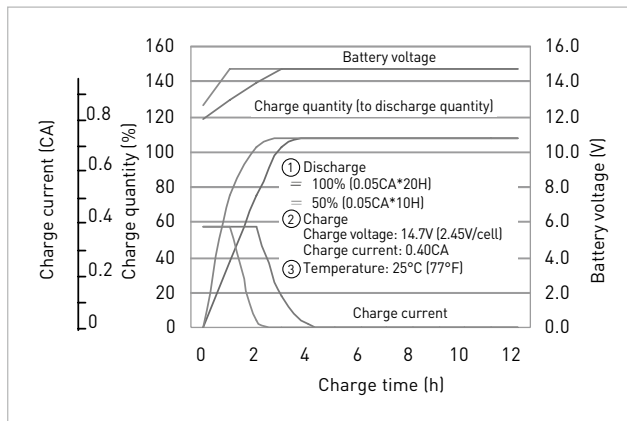

DISCHARGE CAPACITY BY TEMPERATURE AND BY DISCHARGE CURRENT

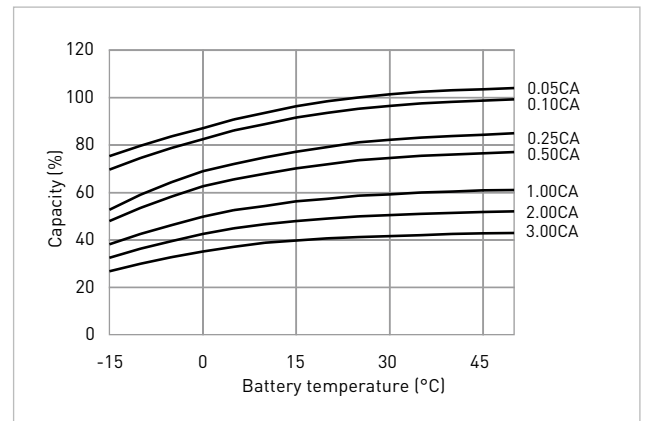

DISCHARGE CHARACTERISTICS

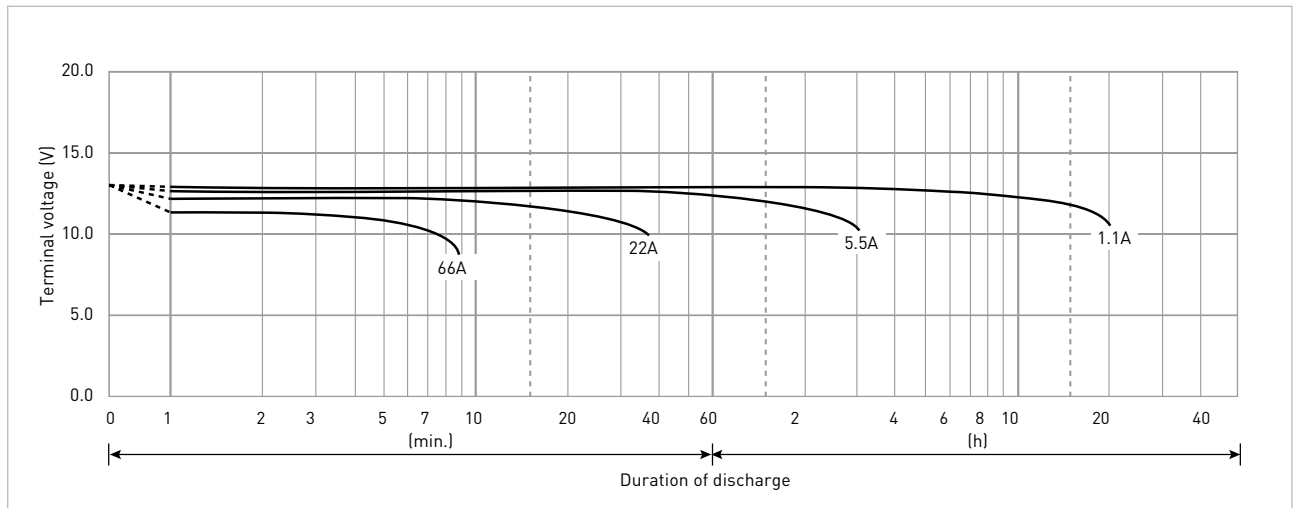

LC-XC1228P/AP

FOR MAIN POWER SUPPLIES.
CYCLE LONG-LIFE TYPE

DIMENSIONS (MM)



Terminal type (option)

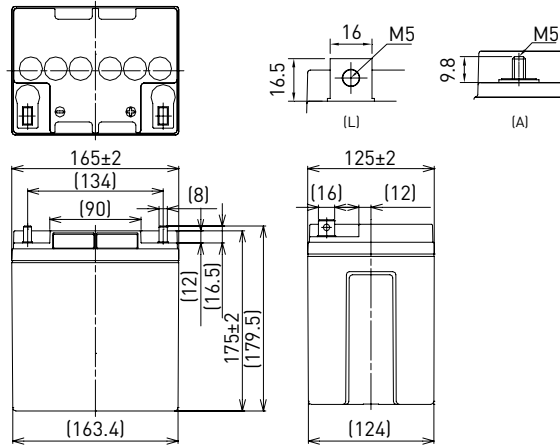

Contents indicated (including the recycle marking, etc.) are subject to change without notice. Battery case resin: standard (UL94 HB)

Specifications		LC-XC1228P/AP
Nominal voltage (V)		12
Nominal capacity	20 hours rate (Ah)	28.0
Dimensions	Length (mm)	125
	Width (mm)	165
	Total height (mm)	179.5
Approx. mass (kg)		10.5
Terminal type		M5 bolt/nut & threaded post
Capacity (25°C)	20 hours rate (Ah)	28.0
	10 hours rate (Ah)	26.0
	3 hours rate (Ah)	22.0
	1 hour rate (Ah)	21.0
Impedance (mΩ)	Fully charged battery (25°C)	10
	40°C	102
Temperature dependency of capacity (%) - 20 hours rate	25°C	100
	0°C	85
	-15°C	65
	Remaining capacity (25°C)	
After 3 months (%)		91
After 6 months (%)		82
After 12 months (%)		64

DURATION OF DISCHARGE VS. DISCHARGE CURRENT

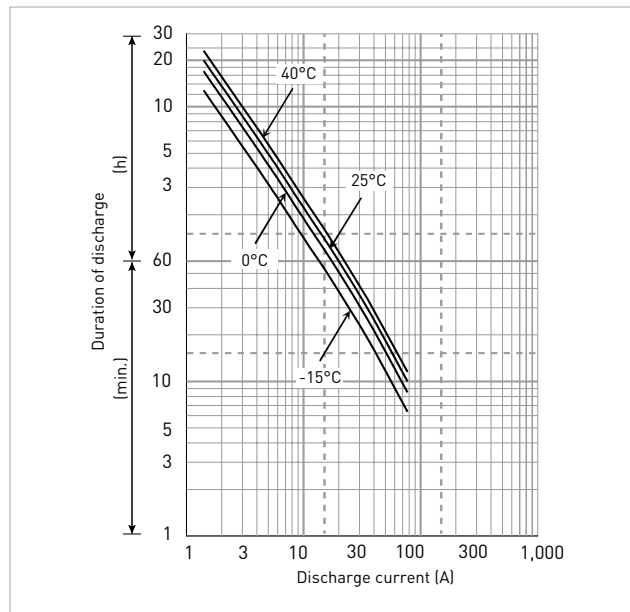

WATT TABLE (25°C)

(Wattage/battery)

Cut-off	5min.	10min.	15min.	20min.	30min.	45min.	1h	1.5h	2h	3h	4h	5h	6h	10h	20h
9.6V	1,160	865	664	585	410	304	260	159	129	91.6	74.1	61.1	50.8	31.8	16.8
9.9V	1,093	849	654	579	404	294	254	156	128	90.4	72.9	60.8	50.4	31.8	16.8
10.2V	1,026	818	643	567	397	288	251	155	127	89.3	71.7	60.5	49.9	31.8	16.8
10.5V	976	784	621	545	386	282	247	154	126	88.1	71.1	60.2	49.5	31.8	16.8
10.8V	903	773	610	539	374	255	218	149	118	84.5	70.5	59.9	49.0	31.8	16.8

AMPERE TABLE (25°C)

(Ampere/battery)

Cut-off	5min.	10min.	15min.	20min.	30min.	45min.	1h	1.5h	2h	3h	4h	5h	6h	10h	20h
9.6V	104	77.2	57.7	50.4	35.0	25.9	22.1	13.5	10.9	7.70	6.20	5.10	4.30	2.60	1.40
9.9V	98.0	75.8	56.9	49.9	34.5	25.0	21.6	13.2	10.8	7.60	6.10	5.06	4.28	2.60	1.40
10.2V	92.0	73.0	55.9	48.9	33.9	24.5	21.3	13.1	10.7	7.50	6.00	5.03	4.25	2.60	1.40
10.5V	87.5	70.0	54.0	47.0	33.0	24.0	21.0	13.0	10.6	7.40	5.95	4.99	4.23	2.60	1.40
10.8V	81.0	69.0	53.0	46.5	32.0	21.7	18.5	12.6	10.0	7.10	5.90	4.95	4.20	2.60	1.40

All mentioned values are average values

LC-XC1228P/AP

CHARGING METHOD (25°C)

Cycle use	Control voltage: 14.5V - 14.9V Initial current: 11.2A or smaller
------------------	---

CUT-OFF VOLTAGE

Discharge current	1.40A - 5.60A	5.6A - 14.0A	14.0A - 28.0A	28.0A - 56.0A	56.0A - 84.0A
Cut-off voltage	10.5V	10.2V	9.9V	9.3V	8.7V

CYCLE LIFE VS. DEPTH OF DISCHARGE (ACC. IEC 61056)

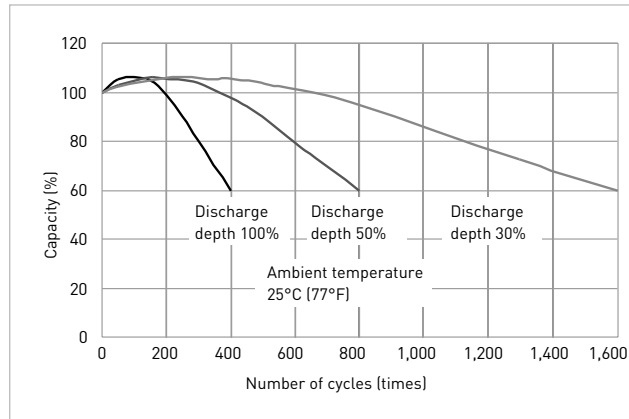

RESIDUAL CAPACITY TEST RESULT

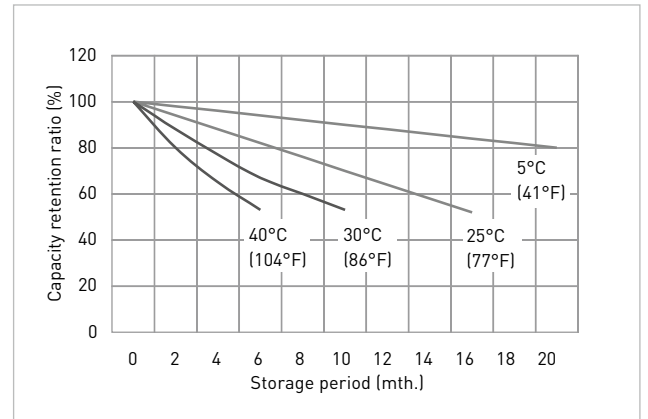

CONSTANT-VOLTAGE CONSTANT-CURRENT CHARGE CHARACTERISTICS FOR CYCLE USE

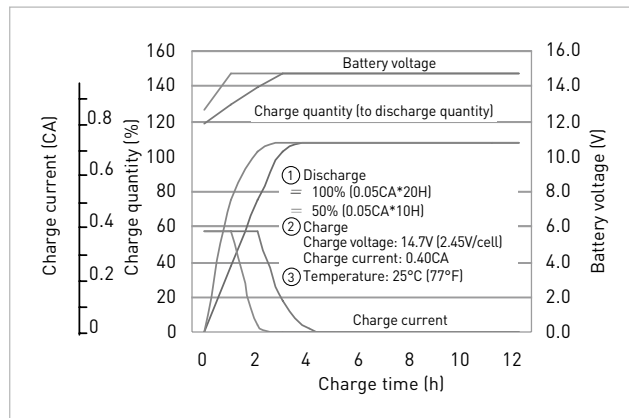

DISCHARGE CAPACITY BY TEMPERATURE AND BY DISCHARGE CURRENT

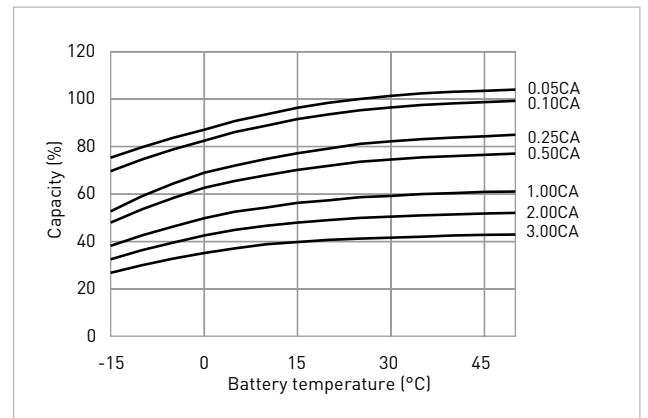

DISCHARGE CHARACTERISTICS

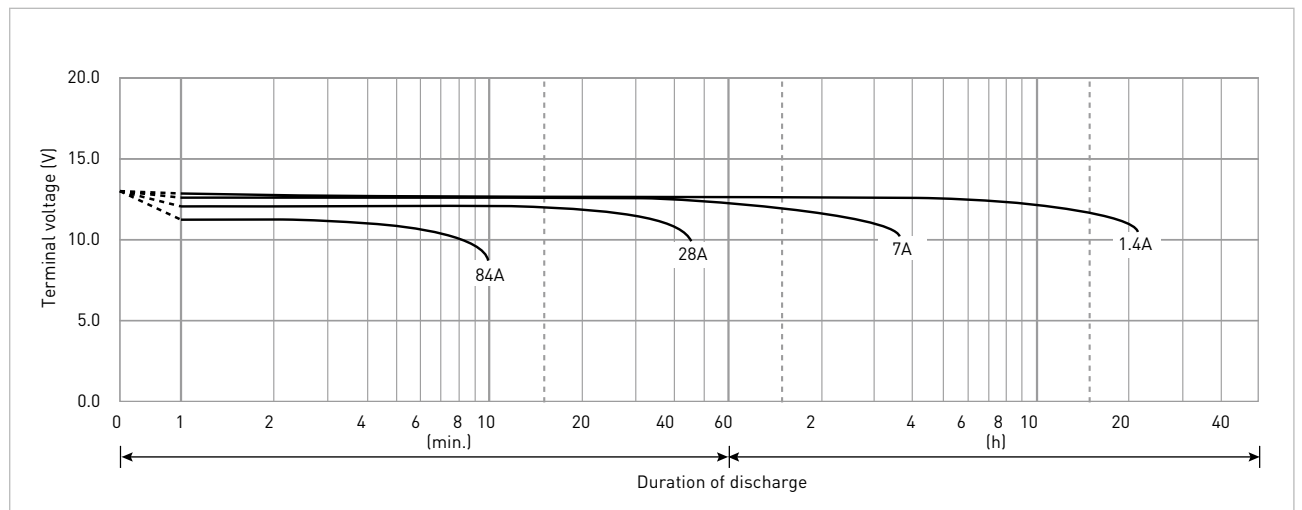

LC-XC1238P/AP

FOR MAIN POWER SUPPLIES.
CYCLE LONG-LIFE TYPE

DIMENSIONS (MM)

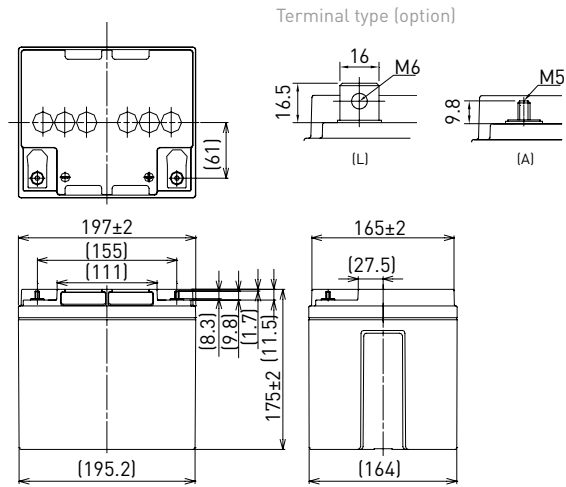

Contents indicated (including the recycle marking, etc.) are subject to change without notice. Battery case resin: standard (UL94 HB)

Specifications		LC-XC1238P/AP
Nominal voltage (V)		12
Nominal capacity	20 hours rate (Ah)	38.0
Dimensions	Length (mm)	165
	Width (mm)	197
	Total height (mm)	179.5
Approx. mass (kg)		15.0
Terminal type	M6 bolt/nut & M5 threaded post	
Capacity (25°C)	20 hours rate (Ah)	38.0
	10 hours rate (Ah)	36.0
	3 hours rate (Ah)	29.0
	1 hour rate (Ah)	23.0
Impedance (mΩ)	Fully charged battery (25°C)	8
	Temperature dependency of capacity (%) - 20 hours rate	
	40°C	102
	25°C	100
	0°C	85
	-15°C	65
Remaining capacity (25°C)	After 3 months (%)	91
	After 6 months (%)	82
	After 12 months (%)	64

DURATION OF DISCHARGE VS. DISCHARGE CURRENT

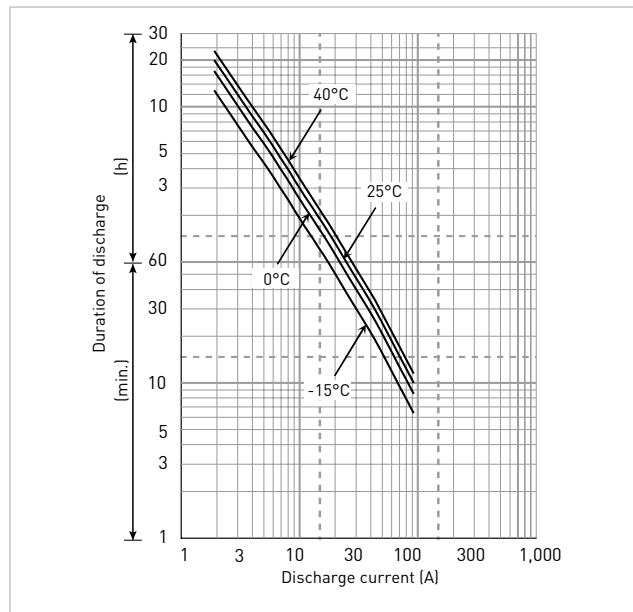

WATT TABLE (25°C)

(Wattage/battery)

Cut-off	5min.	10min.	15min.	20min.	30min.	45min.	1h	1.5h	2h	3h	4h	5h	6h	10h	20h
9.6V	1,349	1,030	800	686	505	351	276	214	169	123	99.2	77.9	68.3	42.0	22.8
9.9V	1,271	1,008	788	682	500	350	269	209	168	120	98.0	76.7	68.0	42.0	22.8
10.2V	1,204	980	768	672	489	349	267	185	167	119	96.8	75.5	67.7	42.0	22.8
10.5V	1,126	952	748	661	480	346	265	183	166	117	95.6	74.9	67.4	42.0	22.8
10.8V	1,098	874	716	640	468	308	247	175	155	114	94.4	74.3	67.1	42.0	22.8

AMPERE TABLE (25°C)

(Ampere/battery)

Cut-off	5min.	10min.	15min.	20min.	30min.	45min.	1h	1.5h	2h	3h	4h	5h	6h	10h	20h
9.6V	121	92.0	69.6	59.1	43.2	29.9	23.4	18.1	14.3	10.3	8.30	6.50	5.70	3.60	1.90
9.9V	114	90.0	68.5	58.8	42.7	29.8	22.8	17.7	14.2	10.1	8.20	6.40	5.68	3.60	1.90
10.2V	108	87.5	66.8	57.9	41.8	29.7	22.7	15.7	14.1	10.0	8.10	6.30	5.66	3.60	1.90
10.5V	101	85.0	65.0	57.0	41.0	29.5	22.5	15.5	14.0	9.80	8.00	6.25	5.64	3.60	1.90
10.8V	98.5	78.0	62.3	55.2	40.0	26.2	21.0	14.8	13.1	9.60	7.90	6.20	5.60	3.60	1.90

All mentioned values are average values

LC-XC1238P/AP

CHARGING METHOD (25°C)

Cycle use	Control voltage: 14.5V - 14.9V Initial current: 15.2A or smaller
------------------	---

CUT-OFF VOLTAGE

Discharge current	1.90A - 7.60A	7.60A - 19.0A	19.0A - 38.0A	38.0A - 76.0A	76.0A - 114A
Cut-off voltage	10.5V	10.2V	9.9V	9.3V	8.7V

CYCLE LIFE VS. DEPTH OF DISCHARGE (ACC. IEC 61056)

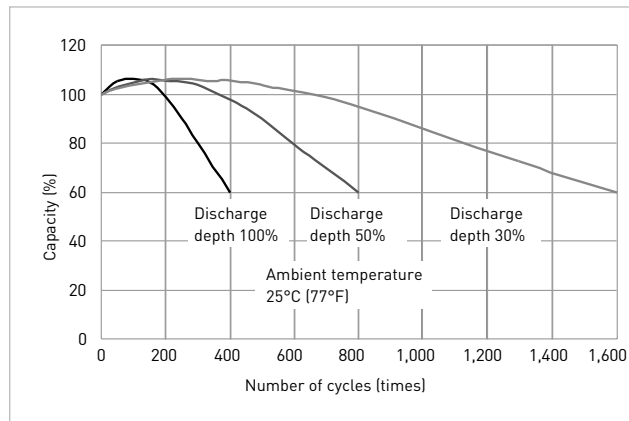

RESIDUAL CAPACITY TEST RESULT

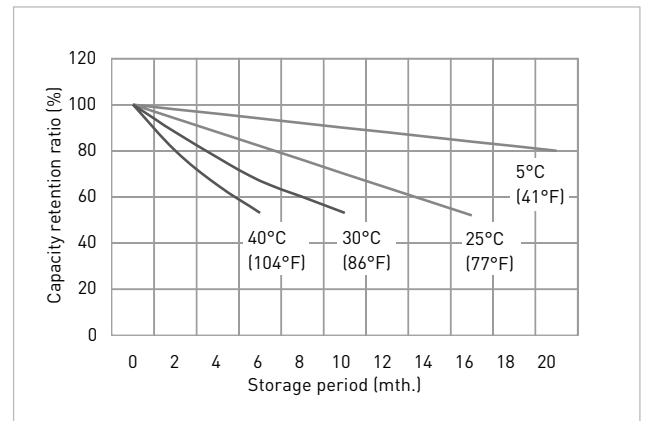

CONSTANT-VOLTAGE CONSTANT-CURRENT CHARGE CHARACTERISTICS FOR CYCLE USE

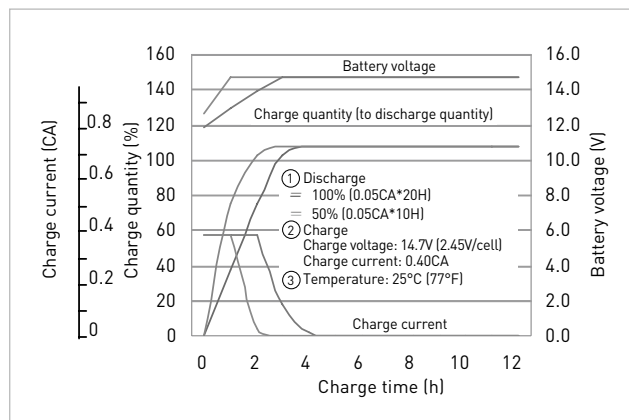

DISCHARGE CAPACITY BY TEMPERATURE AND BY DISCHARGE CURRENT

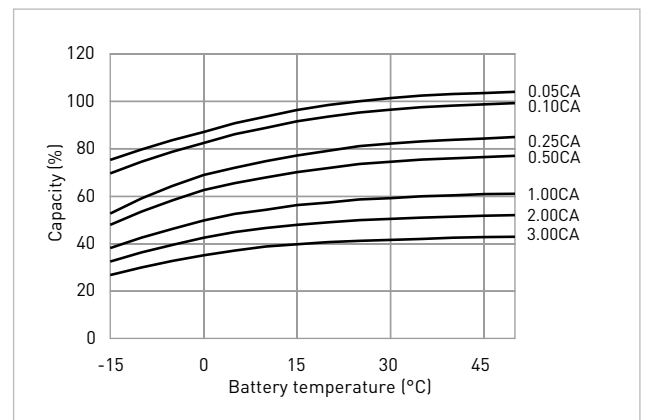

DISCHARGE CHARACTERISTICS

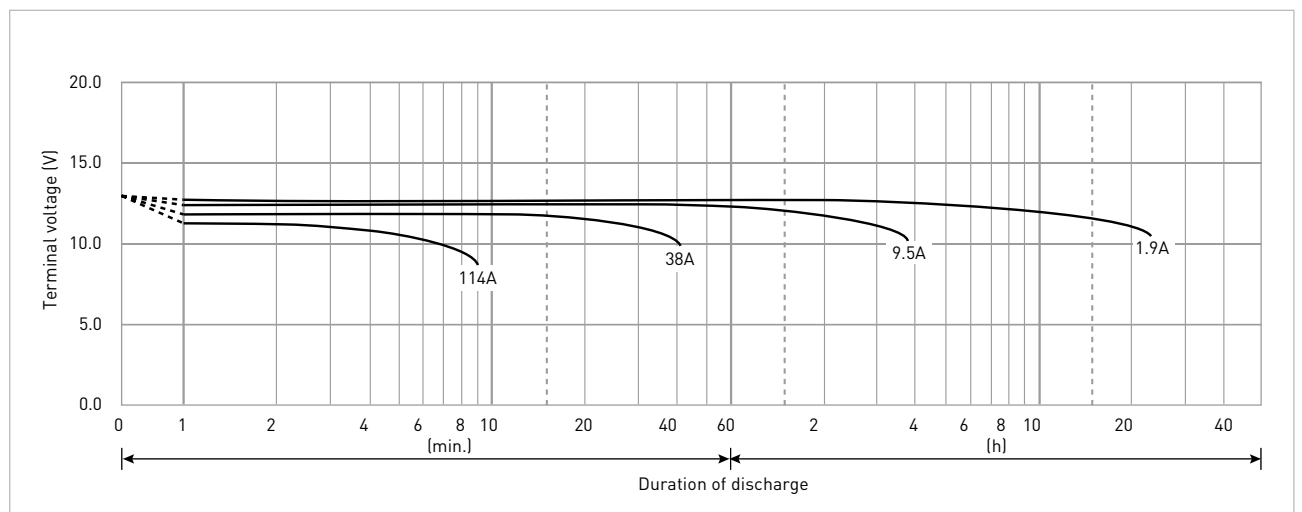

LC-T1270P

FOR ENERGY STORAGE APPLICATIONS.
CYCLE LONG-LIFE TYPE

DIMENSIONS (MM)



Contents indicated (including the recycle marking, etc.) are subject to change without notice. Battery case resin: standard (UL94 HB)

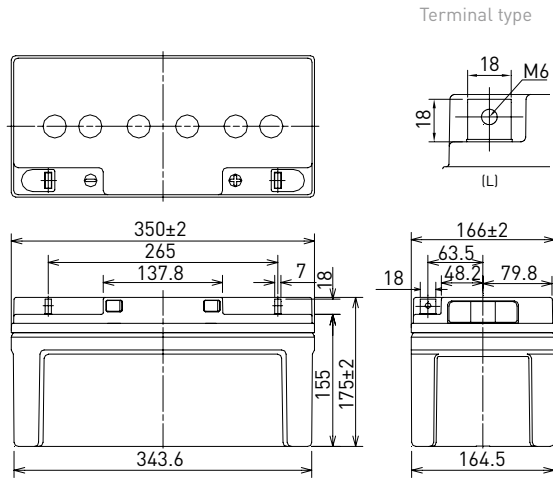

Specifications		LC-T1270P
Nominal voltage (V)		12
Nominal capacity	20 hours rate (Ah)	70
Dimensions	Length (mm)	166
	Width (mm)	350
	Total height (mm)	175
Approx. mass (kg)		24.5
Terminal type		M6 bolt/nut
Capacity (25°C)	20 hours rate (Ah)	70
	10 hours rate (Ah)	66
	3 hours rate (Ah)	56.0
	1 hour rate (Ah)	43.0
Impedance (mΩ)	Fully charged battery (25°C)	
		6
Temperature dependency of capacity (%) - 20 hours rate	40°C	102
	25°C	100
	0°C	85
	-15°C	65
Remaining capacity (25°C)	After 3 months (%)	91
	After 6 months (%)	82
	After 12 months (%)	64

DURATION OF DISCHARGE VS. DISCHARGE CURRENT

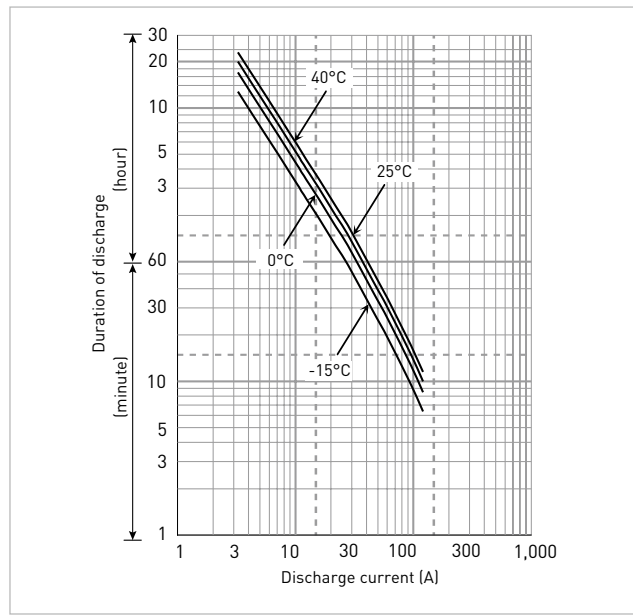

WATT TABLE (25°C)

(Wattage/battery)

Cut-off	5min.	10min.	15min.	20min.	30min.	45min.	1h	1.5h	2h	3h	4h	5h	6h	10h	20h
9.6V	2,312	1,815	1,391	1,078	855	662	504.0	387.0	303.0	241.9	170.0	142.0	126.0	80.90	43.70
9.9V	2,245	1,779	1,364	1,073	846	651	491.0	379.0	295.0	237.2	166.0	138.0	122.0	78.10	43.40
10.2V	2,179	1,745	1,337	1,055	836	639	477.0	368.4	287.0	230.3	163.0	134.0	118.0	75.50	43.20
10.5V	2,116	1,710	1,311	1,002	817	621	464.0	361.1	283.0	217.0	159.0	130.0	115.0	75.20	40.50
10.8V	2,054	1,677	1,285	956	774	609	458.0	350.6	276.0	210.7	155.0	128.0	113.0	73.70	39.80

AMPERE TABLE (25°C)

(Ampere/battery)

Cut-off	5min.	10min.	15min.	20min.	30min.	45min.	1h	1.5h	2h	3h	4h	5h	6h	10h	20h
9.6V	251	175	130	105	79.2	59.6	47.3	36.5	27.4	20.3	15.0	12.6	10.5	6.65	3.56
9.9V	244	172	127	102	77.6	58.4	45.9	35.5	27.3	19.7	14.9	12.2	10.2	6.63	3.53
10.2V	239	167	125	101	76.1	56.7	44.5	34.6	27.2	19.1	14.8	11.9	10.1	6.62	3.52
10.5V	229	162	123	98	74.9	55.1	43.3	33.9	26.5	18.6	14.7	11.8	10.0	6.55	3.50
10.8V	203	159	119	95	72.3	54.2	42.0	33.0	25.2	18.2	14.5	11.5	9.80	6.50	3.49

All mentioned values are average values

LC-T1270P

CHARGING METHOD (25°C)

Cycle use	Control voltage: 14.5V - 14.9V Initial current: 28.0A or smaller
------------------	---

CUT-OFF VOLTAGE

Discharge current	3.5A - 14.0A	14.0A - 35A	35A - 70.0A	70A - 140A	140A - 210A
Cut-off voltage	10.5V	10.2V	9.9V	9.3V	8.7V

CYCLE LIFE VS. DEPTH OF DISCHARGE (ACC. IEC 61056)

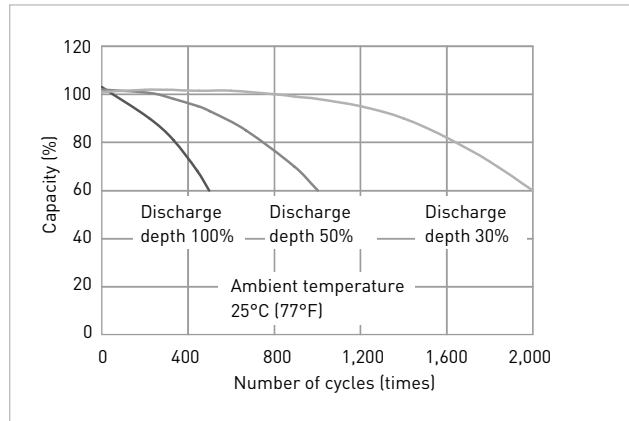

RESIDUAL CAPACITY TEST RESULT

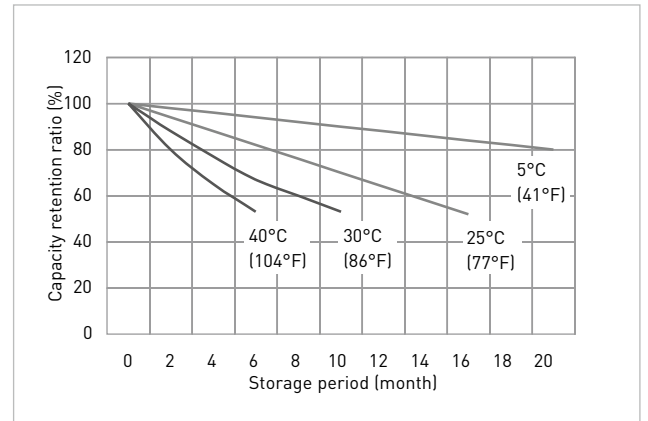

CONSTANT-VOLTAGE CONSTANT-CURRENT CHARGE CHARACTERISTICS FOR CYCLE USE

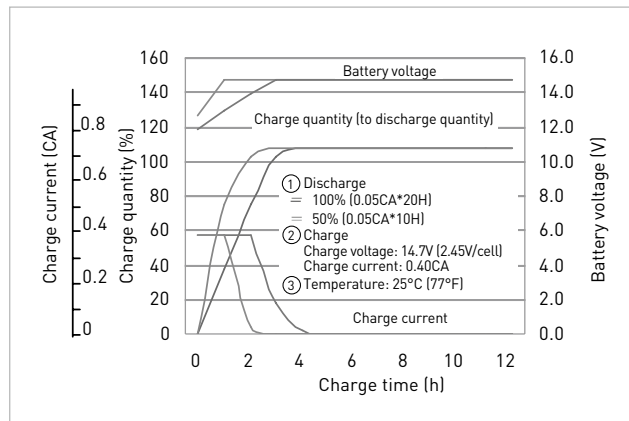

DISCHARGE CAPACITY BY TEMPERATURE AND BY DISCHARGE CURRENT

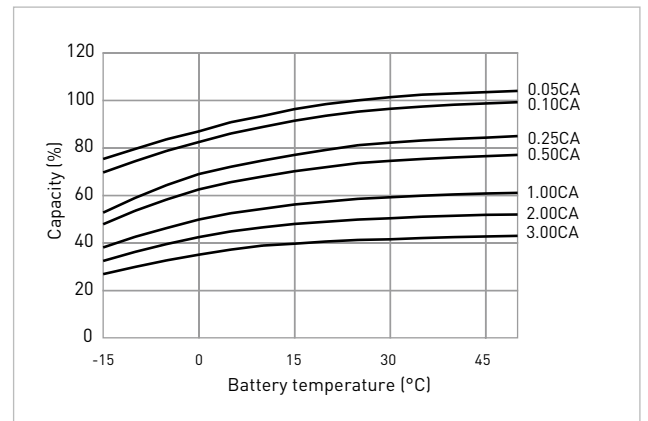

DISCHARGE CHARACTERISTICS

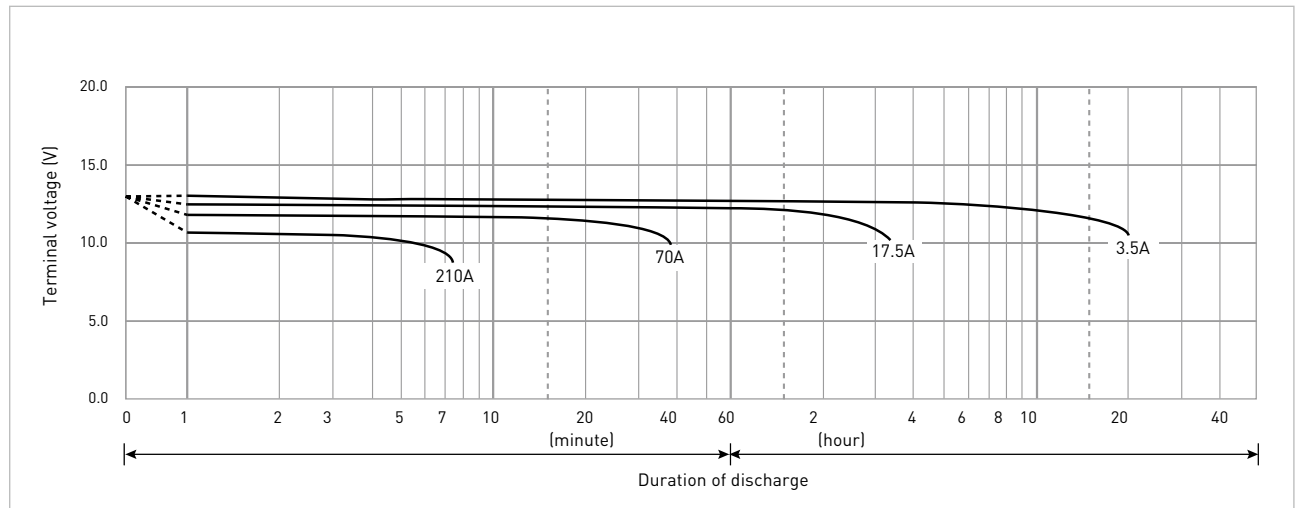

The data in this document are for descriptive purposes only and are not intended to make or imply any guarantee or warranty. Regarding handling and safety please consult our VRLA technical handbook chapter 'Precautions for handling VRLA batteries'.

LC-T12105P

FOR ENERGY STORAGE APPLICATIONS.
CYCLE LONG-LIFE TYPE

DIMENSIONS (MM)



Contents indicated (including the recycle marking, etc.) are subject to change without notice. Battery case resin: standard (UL94 HB)

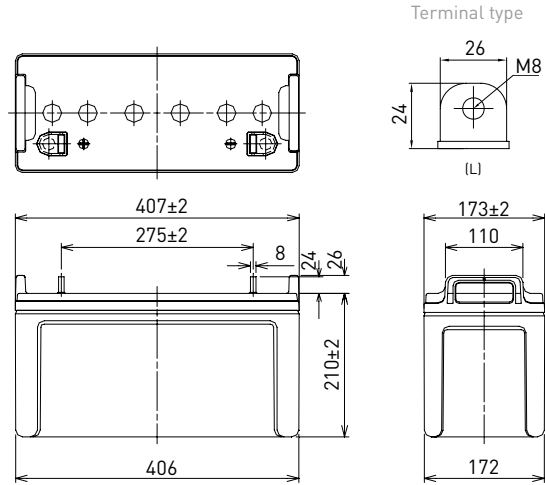

Specifications		LC-T12105P
Nominal voltage (V)		12
Nominal capacity	20 hours rate (Ah)	105
Dimensions	Length (mm)	173
	Width (mm)	407
	Total height (mm)	236
Approx. mass (kg)		34.0
Terminal type		M8 bolt/nut
Capacity (25°C)	20 hours rate (Ah)	105
	10 hours rate (Ah)	101
	3 hours rate (Ah)	84
	1 hour rate (Ah)	70
Impedance (mΩ)	Fully charged battery (25°C)	5
	Temperature dependency of capacity (%) - 20 hours rate	
	40°C	102
	25°C	100
	0°C	85
	-15°C	65
Remaining capacity (25°C)	After 3 months (%)	91
	After 6 months (%)	82
	After 12 months (%)	64

DURATION OF DISCHARGE VS. DISCHARGE CURRENT

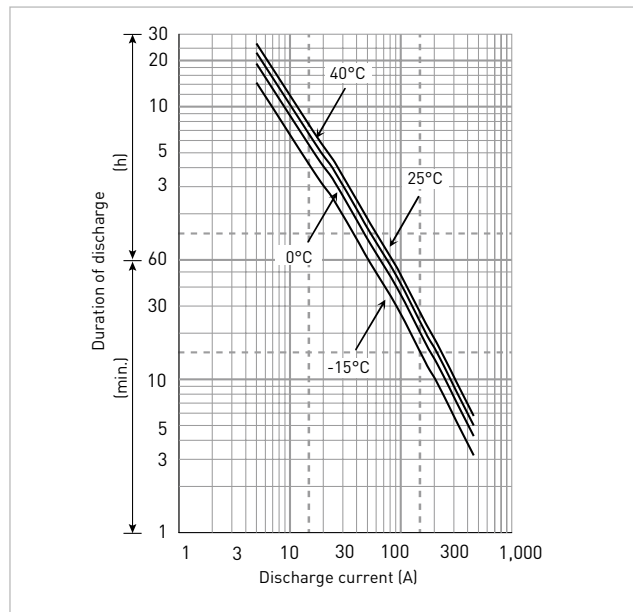

WATT TABLE (25°C)

(Wattage/battery)

Cut-off	5min.	10min.	15min.	20min.	30min.	45min.	1h	1.5h	2h	3h	4h	5h	6h	10h	20h
9.6V	3,400	2,600	2,300	1,949	1,710	1,136	1,005.7	897.9	748.3	354.0	316.1	279.7	248.4	133.94	68.17
9.9V	3,301	2,524	2,233	1,892	1,660	1,103	976.4	871.8	726.5	343.7	306.9	271.6	241.2	130.03	66.19
10.2V	3,205	2,451	2,168	1,837	1,612	1,071	948.0	846.4	705.3	333.7	298.0	263.7	234.2	126.25	64.89
10.5V	3,111	2,379	2,105	1,784	1,565	1,040	920.4	821.7	684.8	324.0	289.3	256.0	227.4	122.57	63.00
10.8V	3,021	2,310	2,044	1,732	1,519	1,010	893.5	797.8	664.8	314.6	280.9	248.5	220.7	119.00	61.17

AMPERE TABLE (25°C)

(Ampere/battery)

Cut-off	5min.	10min.	15min.	20min.	30min.	45min.	1h	1.5h	2h	3h	4h	5h	6h	10h	20h
9.6V	350	270	215	172	137	96	75.8	60.2	47.7	29.7	23.6	18.7	14.9	10.30	5.38
9.9V	340	262	209	167	133	94	73.6	58.4	46.4	29.1	22.9	18.2	14.4	10.15	5.28
10.2V	330	255	203	162	129	92	71.4	56.7	45.0	28.6	22.2	17.6	14.0	10.20	5.26
10.5V	320	247	197	157	125	90	70.0	55.1	43.7	28.0	21.6	17.1	13.6	10.10	5.25
10.8V	311	240	191	153	121	88	68.6	53.5	42.4	27.5	21.0	16.6	13.2	10.00	5.17

All mentioned values are average values

LC-T12105P

CHARGING METHOD (25°C)

Cycle use	Control voltage: 14.5V - 14.9V Initial current: 42.0A or smaller
------------------	---

CUT-OFF VOLTAGE

Discharge current	5.25A - 21.0A	21.0A - 52.50A	52.5A - 105A	105A - 210A	210A - 315A
Cut-off voltage	10.5V	10.2V	9.9V	9.3V	8.7V

CYCLE LIFE VS. DEPTH OF DISCHARGE (ACC. IEC 61056)

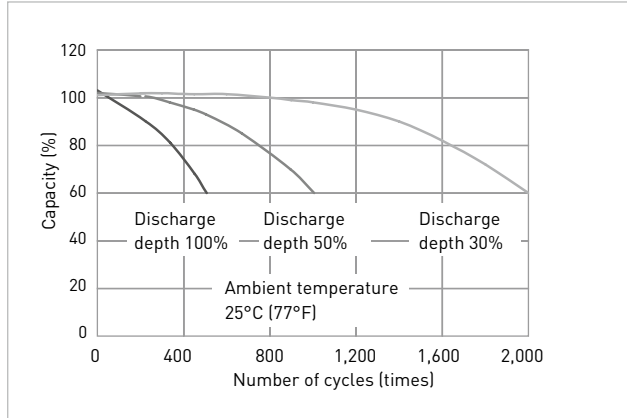

RESIDUAL CAPACITY TEST RESULT

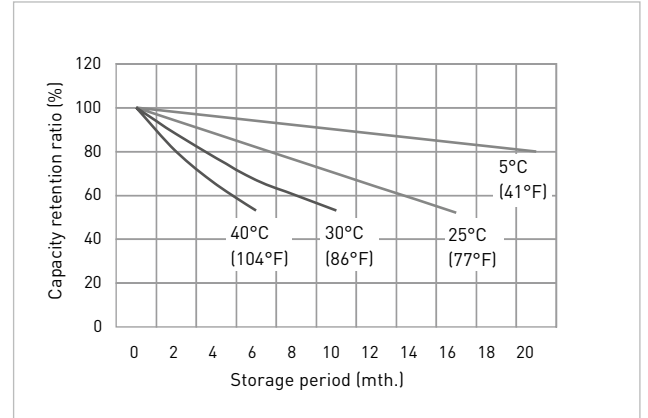

CONSTANT-VOLTAGE CONSTANT-CURRENT CHARGE CHARACTERISTICS FOR CYCLE USE

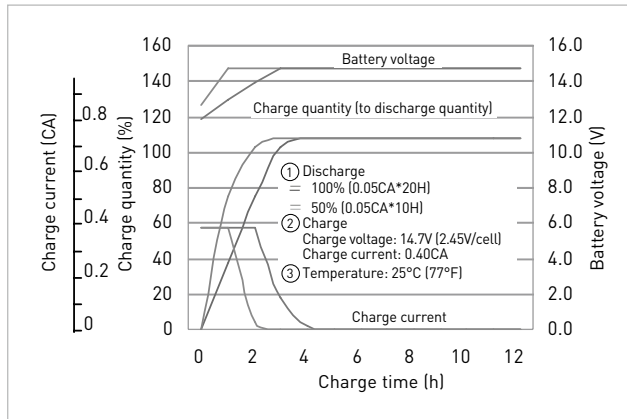

DISCHARGE CAPACITY BY TEMPERATURE AND BY DISCHARGE CURRENT

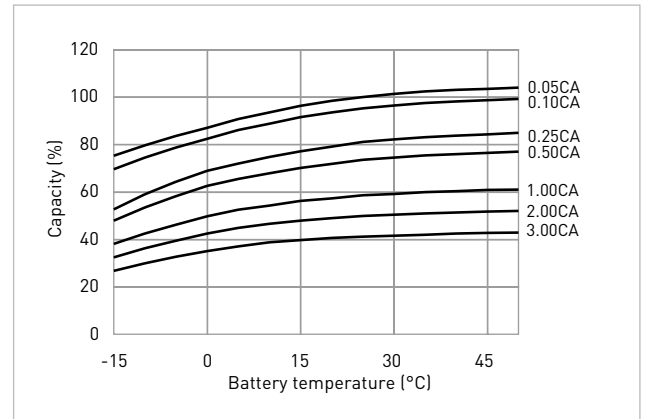

DISCHARGE CHARACTERISTICS

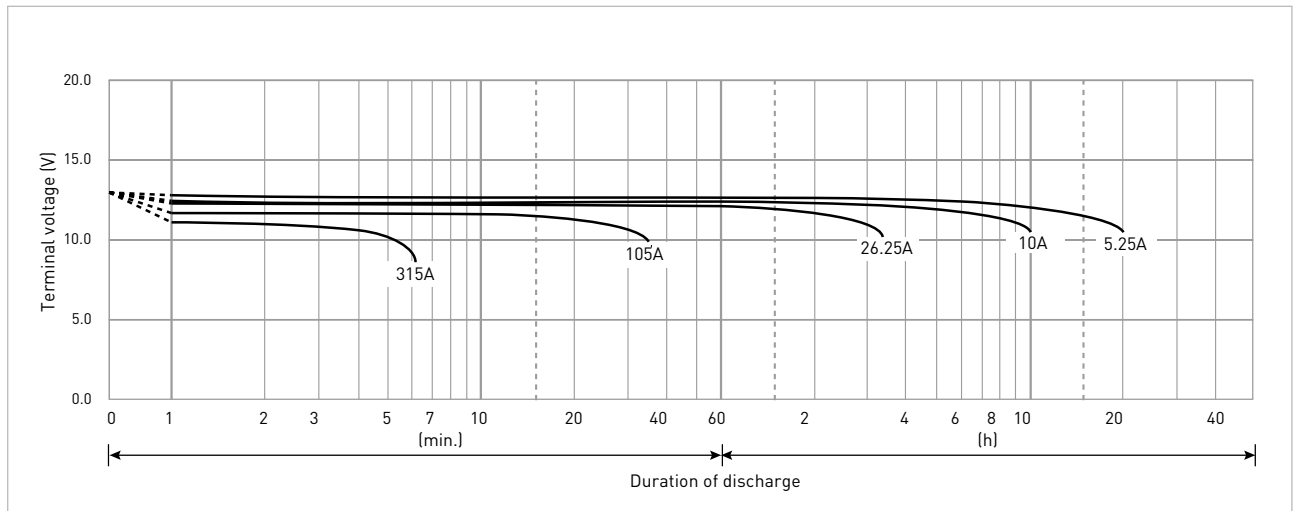

GLOSSARY OF MAIN BATTERY TERMS

ABS RESIN

A plastic material largely used for the case and cover of batteries.

ACTIVE MATERIAL

The substance which electrochemically reacts in the electrode of batteries. Lead acid batteries adopt Lead Dioxide for the positive electrode and spongy Lead for the negative electrode.

AMBIENT TEMPERATURE

Average temperature in the vicinity of the battery.

AVAILABLE CAPACITY

The capacity actually available from a cell/battery. The available capacity is the capacity of a battery when it discharges at a specified hours rate, and expressed in hours rate and Ah.

BOLT FASTENING TERMINAL

A type of battery terminals, to which lead wires are connected with bolts.

BUILT-IN THERMOSTAT

The built-in thermostat is a resettable switch built in a battery for temporarily Cut-off the battery circuit when the temperature of the battery exceeds a preset value or when the battery charges/discharges at a higher rate than predetermined.

CAPACITY

The electric capability of a battery. It usually means ampere-hour capacity expressed in Ah or C (coulomb).

CELL

The minimum battery unit which composes a storage battery. Nominal voltage of the cell of a lead acid battery is 2V.

CHARGE

The operation of supplying a battery with a DC current from an external power source to have the electrode active materials conduct chemical reactions then to store electric energy as chemical energy in the battery.

CHARGE ACCEPTANCE TEST

Test of batteries to check whether or not they are adequately recharged after discharge.

CHARGING EFFICIENCY

General term for ampere-hour efficiency and watt-hour efficiency. In many cases it means the ampere-hour efficiency.

CHINA ROHS

Environment Friendly Use period (EFUP) is the number of time before any of the RoHS substances are likely to leak out, causing possible harm to health and the environment.

CONSTANT CURRENT CHARGE

A method of charging: to charge a battery with a constant current.

CONSTANT VOLTAGE CHARGE

A method of charging: to charge a battery by applying a constant voltage to the terminals.

C-RATE

A charge or discharge current rate expressed in A or mA. It is numerically the same as the hours rate capacity of a battery expressed in Ah of the rated capacity.

CUT-OFF VOLTAGE OF DISCHARGE

The terminal voltage of a battery at which discharging should be discontinued. This voltage depends on discharge current, type of electrodes, and construction of battery.

CYCLE LIFE

The number of charge/discharge/rest cycles a cell/battery can provide. Cycle life is usually expressed by the number of cycles available before duration of discharge decreases to half of the initial value.

DEPTH OF DISCHARGE

A value to express the state of discharge of a battery. The depth of discharge is generally expressed by the ratio of discharge amount to rated capacity of the battery.

DISCHARGE

To draw the electric energy stored in a cell/battery.

DISCHARGE RATE

The term to express the magnitude of discharge current. When assuming discharge current and time to discharge cut-off voltage t hours, this discharge is called t hours rate (tHR) discharge, and the current is called t-hours rate discharge current. When time t is minutes instead of hours, tMR is used.

DUTY CYCLE TEST

Test of batteries in ordinary use including charge, discharge and rest.

ELECTROLYTE

The medium which serves to conduct ions in the electrochemical reactions in batteries. The lead acid battery uses diluted sulfuric acid as the electrolyte.

ENERGY DENSITY

Energy available per unit approx. mass or unit volume of a cell/battery. Energy density is expressed in Wh/kg or Wh/l.

FLOAT CHARGE

The system in which a constant voltage is continuously applied to a battery connected to a rectifier in parallel with a load to maintain the battery in charged state: on occurrence of power failure or load variation, the battery supplies power to the load without any short break.

GAS RECOMBINATION

Capability of a battery to recombine (or absorb) internally generated oxygen gas at the negative plate. The greater this capability is, the lower the charge current.

HIGH RATE DISCHARGE

A very rapid discharge of a battery. (In many cases it means discharging at approx. 1CA or higher rate.)

IMPEDANCE

The resistance within a battery: it is the total of individual resistances of the electrolyte and the positive and negative plates. Impedance is measured with the four-terminal sensing method (1,000Hz) and expressed in the composite value of resistance component and capacitance component.

INTERNAL PRESSURE

The pressure within a sealed battery. Internal pressure of a battery is increased by Oxygen gas which is generated from the positive plate at the end of charging.

INTERNAL SHORT-CIRCUIT

Touching of the positive and negative plates within a cell.

LIFE

The time period until a cell/battery loses its expected characteristics.

LOW MAINTENANCE

Low maintenance means that no watering nor equalizing charge is required in operating batteries.

LOW-VOLTAGE CUT-OFF

A circuit designed to discontinue discharge of a battery at a predetermined voltage level.

MALE TAB

The metallic pieces which are attached to a VRLA battery as the terminals.

MEMORY EFFECT

A phenomenon where a temporary drop of discharge voltage is observed during deep discharge of an Alkaline rechargeable battery which has been subjected to shallow charge/discharge cycles or trickle charging over long time.

NEGATIVE PLATE

The battery electrode into which a current from the external circuit flows during discharging. The negative plate has lower electric potential than the positive plate to the electrolyte. The negative plate is incorporated with connection parts such as the electrode pole.

NOMINAL VOLTAGE

A nominal value to indicate the voltage of a cell battery. Generally, nominal voltage value of a battery is somewhat lower than its electromotive force. Nominal voltage of the lead acid battery is 2.0V per unit cell.

OPEN CIRCUIT VOLTAGE

Measured voltage of a cell/battery which is electrically disconnected from the external circuit.

OVERCHARGE

Continued charging of a fully charged cell/battery. With batteries which require watering, overcharge causes electrolysis of water, resulting in rapid decrease of electrolyte. Generally, overcharge adversely influences battery life.

OVERDISCHARGE

Discharge of a battery to a voltage below a predetermined cut-off voltage.

PARALLEL CHARGE

Simultaneous charging of two or more batteries connected in parallel. In cyclic use of batteries, specifically, the parallel charge tends to cause an imbalance in charge state among the batteries, which may shorten their service life.

POLYPROPYLENE RESIN

A plastic material which is often used for the case and cover of batteries.

POSITIVE PLATE

The battery electrode from which a current flows to the external circuit during discharging. The positive plate has higher electric potential than the negative plate to the electrolyte. The positive plate is incorporated with connection parts such as the electrode lugs.

QUICK CHARGE (RAPID CHARGE)

Charging in a short time with a large current.

RATED CAPACITY

The stated capacity of a battery; namely, the ampere-hour amount which can be drawn from the battery in fully charged state at a specified temperature, at a specified discharge rate, and to a specified cut-off voltage. The symbol CN may be used to express the rated capacity of N-hours rate.

RECHARGEABLE BATTERY

The rechargeable battery is a system comprising two different electrodes and an ion-conductive medium, which is capable of converting chemical energy to electric energy, and vice versa. It is also called a secondary battery.

REFRESH CHARGE (AUXILIARY CHARGE)

Charging of a battery mainly to compensate for its self-discharge.

RESIDUAL CAPACITY

Remaining capacity of a battery after partial discharge or after storage for long time.

RETAINER TYPE

A method to control flowing electrolyte in a battery with the retainer mat, etc.

REVERSE CHARGE

Charging of a battery with its polarity reversed.

SELF-DISCHARGE

Reduction in capacity of a battery while no current is drawn by the external circuit. Self-discharge depends on temperature: amount of discharge approximately doubles by each (10°C) rise of ambient temperature.

SEPARATOR

A porous or microporous liquid-absorbent material which is installed between the battery electrodes for preventing short-circuit, securing the separation of the electrodes and retaining electrolyte. The separator should be resistant to oxidation and chemicals; it should excel in electric insulation and liquid-retention; and it should not disturb diffusion of the electrolyte and ionic conduction.

STANDBY USE

General term of constant standby battery systems. Batteries are kept charged by trickle/float method at all times in preparation for unforeseen power disruptions.

TEMPERATURE COMPENSATION

Compensation of charge voltage for temperature variation of a cell/battery or in its vicinity. Qualitatively, charge voltage should be corrected to higher side for low temperatures and to lower side for high temperatures.

TERMINAL VOLTAGE AT DISCHARGE

The voltage of a battery during discharging.

THERMAL RUNAWAY

Such phenomena as an excessively high set-up voltage in constant-voltage charging of a battery and a very high battery temperature cause charge current to increase, which then raises the temperature further: this vicious cycle is called thermal runaway, which may, in the worst case, result in breakage of the battery due to heat.

TRICKLE CHARGE

To charge a battery in the state of disconnection from the load to compensate for its self-discharge.

TRICKLE LIFE

The service life of a battery in the trickle use. Usually, the trickle life is the time expressed in years before the dischargeable time of the battery decreases to a half of the initial value.

UL

Abbreviation of Underwriters Laboratories Inc. in USA. The UL establishes various safety standards, and performs official recognition of materials, parts and products.

UPS (UNINTERRUPTIBLE POWER SUPPLY)

Equipment or system which is automatically connected to the load to supply power if the main power fails.

VENT (ONE WAY VALVE)

A valve on each cell which automatically releases gas from the battery when internal pressure of the battery exceeds a predetermined value: it prevents breakage of the battery due to excessive internal pressure caused by the gas generated by charging or other reasons. The valve also serves to prevent outside air from entering batteries.

FIND THE RIGHT CONTACT



Website for Panasonic Battery Finder

Get more information on Panasonic Battery Finder website.

<http://industry.panasonic.eu/battery-finder>

<http://industry.panasonic.eu/battery-finder-html-app>



App Stores for Panasonic Battery Finder

The Panasonic Battery Finder App is available for Android and iOS (iPhone) devices and can be downloaded free of charge in both stores. Scan QR code to be redirected to the appropriate store and download app.

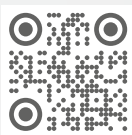

E-mail and website for all European countries

battery-solutions@eu.panasonic.com

<http://industry.panasonic.eu>

Notice to Readers

It is the responsibility of each user to ensure that every battery application is adequately designed safe and compatible with all conditions encountered during use, and in conformance with existing standards and requirements. This literature contains information concerning cells and batteries manufactured by Panasonic Corporation. This information is descriptive only and is not intended to make or imply any representation, guarantee or warranty with respect to any cells and batteries. Cell and battery designs are subject to modification without notice.

This catalog has been produced using unchlorinated paper.

Panasonic®

Panasonic is a registered trademark of Panasonic Corporation. Printed in Germany 2017

© Panasonic Corporation

For more details please contact:

United Kingdom/Ireland

Panasonic Industry Europe GmbH (PIEU)

Willoughby Road
Bracknell Berkshire
RG12 8FP, England

Phone: +44 1344 - 8532 60

Fax: +44 1344 - 8533 13

Panasonic Italia

Branch Office of

Panasonic Marketing Europe GmbH

Viale dell'Innovazione 3

20126 Milano, Italy

Phone: +39 02 - 6788 - 232

Fax: +39 02 - 6788 - 207

Spain/Portugal

Panasonic Industry Europe GmbH (PIEU)

Sucursal en España

Parque Empresarial @ Sant Cugat,

Via Augusta 15-25

Edificio B2 Planta 4 Oficina 17

08174 Sant Cugat del Valles

Barcelona, Spain

Phone: +34 93 - 504 30 10

Fax: +34 93 - 675 58 92

France

Panasonic Industry Europe GmbH (PIEU)

10, rue des petits ruisseaux

91370 Verrières-le-Buisson, France

Phone: +33 1 - 60 13 57 62

Fax: +33 1 - 60 13 57 72

Germany

(all other European countries)

Panasonic Industry Europe GmbH (PIEU)

Winsbergring 15

22525 Hamburg, Germany

Phone: +49 40 - 85 49 - 63 73

Fax: +49 40 - 85 49 - 62 38