



## PRODUCT CATALOGUE

# Shelly

## SMART AUTOMATION SYSTEMS





## TABLE OF CONTENTS

INTRODUCTION .....	3
SHELLY CLOUD .....	4-5
SHELLY PLUS series .....	6-7
SHELLY PLUS 1 .....	8-9
SHELLY PLUS 1PM .....	10-11
SHELLY PLUS 2PM .....	12-13
SHELLY PLUS i4 .....	14-15
SHELLY PLUS H&T .....	16-17
SHELLY PLUS SMOKE .....	18-19
SHELLY PLUS PLUG S .....	20-21
SHELLY PLUS PLUG UK .....	22-23
SHELLY PLUS PLUG IT .....	24-25
SHELLY 1 .....	26-27
SHELLY DIMMER2 .....	29-29
SHELLY RGBW2 .....	30-31
SHELLY 1L .....	32-33
SHELLY EM .....	34-35
SHELLY 3EM .....	36-37
SHELLY UNI .....	38-39
SHELLY PLUG .....	40-41
SHELLY PLUG S .....	42-43
SHELLY BUTTON 1 .....	44-45
SHELLY MOTION 2 .....	46-47
SHELLY H&T .....	48-49
SHELLY TRV .....	50-51
SHELLY FLOOD .....	52-53
SHELLY DOOR/WINDOW 2 .....	54-55
SHELLY GAS .....	56-57
SHELLY DUO .....	58-59
SHELLY DUO RGBW .....	60-61
SHELLY VINTAGE .....	62-63
SHELLY PRO series .....	64-65
SHELLY PRO 1 .....	66-67
SHELLY PRO 1PM .....	68-69
SHELLY PRO 2 .....	70-71
SHELLY PRO 2PM .....	72-73
SHELLY PRO 4PM .....	74-75
SHELLY PRO 3 .....	76-77
SHELLY PRO 3EM .....	78-79
ACCESSORIES .....	80
WALL SWITCH FOR SMART RELAYS .....	81

## MAKE YOUR HOME AND OFFICE SMART

Shelly is a line of home automation devices that allows customers to control their home directly through a mobile phone or with a preferred home assistant. Shelly's devices are retrofit, which makes them suitable for every electrical installation with no need of additional changes or improvements.

### With Shelly you can:

- > Control the lights by adjusting brightness, colors, and set custom schedules.
- > Control the home appliances or office equipment from anywhere.
- > Save energy and money with precise power metering.
- > Set custom automation features.
- > Monitor temperature, humidity, and brightness.
- > Receive immediate notifications in case of any status changes.
- > Power consumption control

All Shelly devices are designed to offer maximum comfort of living, safety and easy installation.

**Shelly - smart solutions for every home and office!**



# SHELLY APP

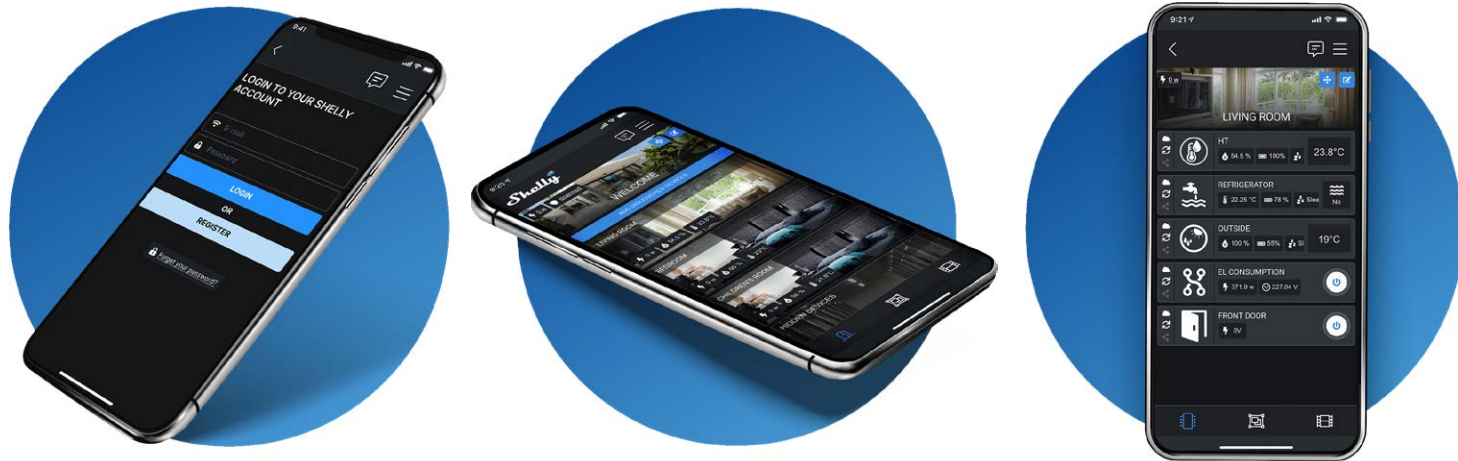

## CONTROL YOUR HOME AND OFFICE WHEREVER YOU ARE! NO HUB REQUIRED!

All Shelly devices have:

- Embedded Web server
- Wi-Fi control and connectivity
- APIs for observation and control

## YOUR SHELLY ACCOUNT

Shelly App user account is required to access, include, and control Shelly devices through the application. Once Shelly account is registered,

- Connect to existing W-Fi network or use Access Point mode locally to control Shelly devices
- Include, manage, and operate as many Shelly devices needed
- Configure devices and manage individual settings to every device individually
- Set custom scheduling for automatic actions by Shelly devices
- Create personalized rooms for more convenient control of the devices
- Define custom Groups to control multiple devices with one command in the app
- Build simple and complex scenes by combining Shelly devices to trigger certain actions in your home automation
- Monitor current and past electrical power consumption of the electrical circuit(s) and loads (for Shelly devices equipped with Power measuring capabilities)
- Build complex automation solutions for improved energy and operational efficiency
- Real time alerts and notifications based on your preference

# FREE MOBILE APP

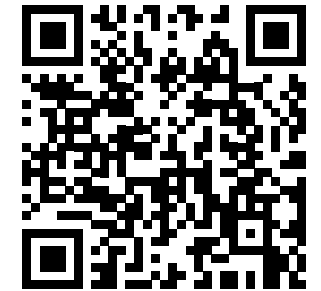

## SHELLY CLOUD SERVICES

Shelly App offers possibility to control all Shelly devices remotely from any internet connection by using the Shelly Cloud Services – our own free cloud service with data storage.

## HIGHLY COMPATIBLE!

Shelly devices are compatible with the most widely accepted both local and cloud based home automation platforms. Having a Shelly user account is necessary to include your Shelly devices to home automation platform.

All Shelly devices come with a REST API documentation, which is available at

<http://shelly-api-docs.shelly.cloud/>

MQTT is supported by our firmware, which provides additional flexibility in the integration of Shelly to your home automation solution. And more integrations are added frequently.





# NEXT GENERATION HOME AUTOMATION AND CONTROL

Shelly smart relays now come with perfected electrical appliances control through an extremely fast processor, quicker connectivity, improved integration, and enhanced safety! You can now add devices easily via Bluetooth connection, using Shelly Cloud App. Shelly Plus line supports TLS encryption and has an improved shell for standardized support for external sensor plugs.



Extremely fast processor



Bluetooth connectivity



Improved integration



Enhanced safety



Scripting

## IMPROVED AND COMPACT SHELL

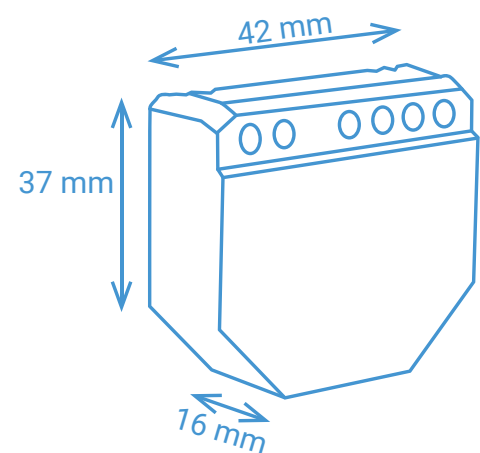

Shelly Plus line comes in a unified and improved form with small dimensions that allow easy fit behind any wall switch or wall socket, and are fully retrofit. Each Plus line device comes with a wiring diagram printed on its shell to ensure safe and easy installation.

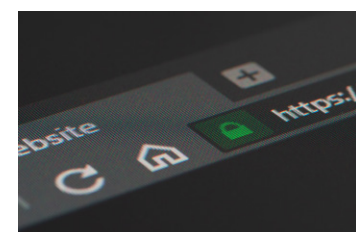

### HTTP/HTTPS webhooks

Get notifications or control another compatible equipment or 3rd party automation system.

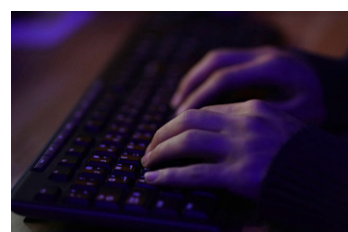

### Scripting for custom automation

Get enhanced functionalities and additional processes settings for a specific integration or function.

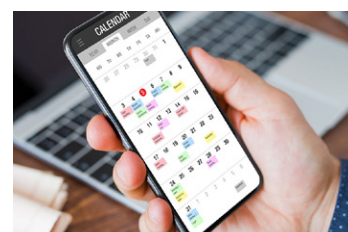

### Weekly scheduling automation

Quickly set actions based on your daily or weekly schedule.

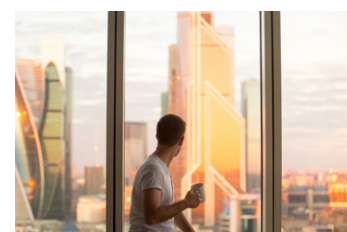

### Smart actions for dynamic control

Set Shelly Plus devices to switch on/off the power, based on the Sunset/Sunrise hour and enjoy dynamic control.



Improved API interface



Standardized RPC



Lower implementation cost

## IMPROVED INTEGRATION

Shelly Plus line has an improved API interface and standardized RPC, allowing a broad range of cloud-connected and local integrations for a much lower cost for implementation. Scripting functionalities allow customization of home automation experience with a specific integration.

## ENHANCED SAFETY & SECURITY

Shelly Plus line provides enhanced safety with additional temperature sensing software thresholds for control and prevention of failures. Devices' firmware now supports more encryption modes and secure storage.

An improve security is guaranteed by MQTT and WSS support, as well as custom certificates support for a broad range of use cases. Devices can be used with your one local or a centralized server, keeping them fully isolated from the public Internet.



Overtemperature protection



Failures prevention



MQTT and WSS support

## SHELLY PLUS LINE

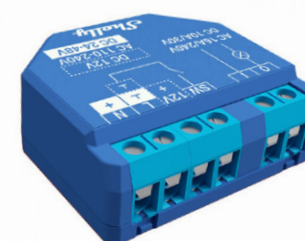

SHELLY PLUS 1



SHELLY PLUS 1PM



SHELLY PLUS 2PM

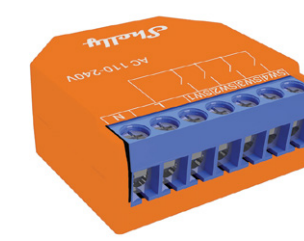

SHELLY PLUS i4



# Shelly PLUS 1



## PERFECTED HOME AUTOMATION EXPERIENCE AND ENHANCED LIGHTING CONTROL!

Intended for mounting behind the wall switch console or power socket, **Shelly Plus 1** brings enhanced control and automatization of the lights, garage door, the irrigation system, bathroom fan, and pretty much every old electrical appliances. Thanks to its small dimensions, it can fit even in the tiniest spaces.

### LIGHTS THAT FOLLOW YOUR SCHEDULE

Automate your lights with Shelly Plus 1 and use Shelly App to set automated scenes based on hour or sunset/sunrise or based on the hour you come back from work.

### GARAGE DOOR CONTROL

Easily automate your garage door and control it no matter where you are! Shelly Plus 1 has operational voltages of 12V DC and 24-48V DC.



### IRRIGATION SYSTEM THAT FOLLOWS THE WEATHER

Use scripting functionalities and Shelly Plus 1 to automate your irrigation system. That way it will water your garden only when it is sunny, skipping the rainy days.



#### Wi-Fi operated

Connect Shelly Plus 1 to your Wi-Fi network. No HUB required.



#### Bluetooth

Add devices quickly and easily via Bluetooth connection, using Shelly Cloud App.



#### Dry contacts

Use a wide range of output voltage levels. Supports low voltages.



#### Extremely fast processor

For immediate command execution and notification.



#### Enhanced safety

Over-temperature protection for prevention of failures.



#### Enhanced security

MQTT and WSS support, TLS certificate support and management for a broad range of use cases.



#### Improved API interface

Broad range of cloud connections and local integrations.



#### No hub required

Control directly without a hub through your smartphone with Shelly Cloud App.



#### Highly compatible

Use with your preferred home automation platforms and voice assistants.

### TECHNICAL SPECIFICATIONS

<b>Power supply</b>	<ul style="list-style-type: none"> <li>• 110-240 VAC, 50/60 Hz</li> <li>• 24-48 VDC</li> <li>• 12 VDC</li> </ul>
<b>Max load</b>	16 A
<b>Complies with EU standards:</b>	<ul style="list-style-type: none"> <li>• RE Directive 2014/53/EU</li> <li>• LVD 2014/35/EU</li> <li>• EMC 2014/30/EU</li> <li>• RoHS2 2011/65/EU</li> </ul>
<b>Working temperature</b>	-20°C ÷ 40°C
<b>Max RF output power</b>	13.45 dBm
<b>Wireless/Wi-Fi Protocol</b>	802.11 b/g/n (2.4 GHz)
<b>Frequency:</b>	2412 - 2472 MHz
<b>Operational range (depending on local conditions)</b>	<ul style="list-style-type: none"> <li>• up to 50 m outdoors</li> <li>• up to 30 m indoors</li> </ul>
<b>Dimensions (HxWxL)</b>	42x37x16 mm
<b>Electrical consumption</b>	< 1.2 W
<b>Wire cross section range</b>	0.5 ÷ 1.5 mm <sup>2</sup>

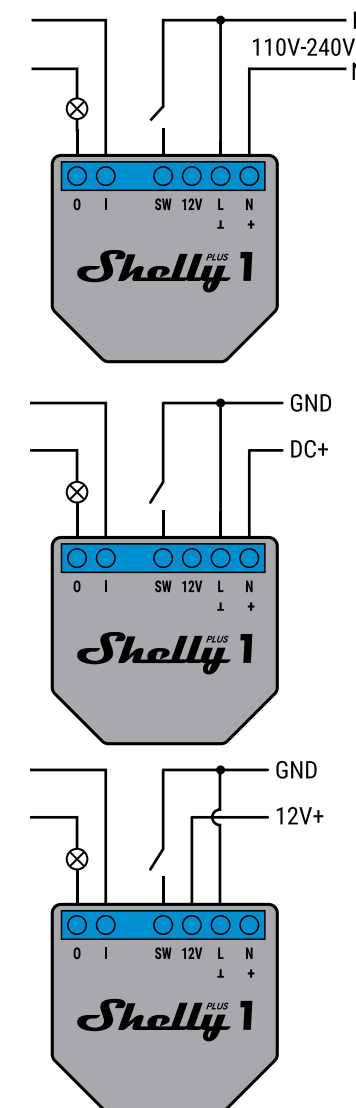

#### Legend

##### Terminals:

- N: Neutral terminal
- L: Live (110-240 V) terminal
- O: Relay output terminal
- I: Relay input terminal
- SW: Switch terminal
- ⊕: DC positive terminal (24-48 V)
- ⊥: DC ground terminal
- 12 V: DC positive terminal (12 V stabilized)

##### Wires:

- N: Neutral wire
- L: Live (110-240 V) wire
- GND: DC ground wire
- DC+: DC positive (24-48 V) wire
- 12V+: DC positive (12 V) wire

# Shelly PLUS 1PM



## NEXT GENERATION APPLIANCES CONTROL WITH PRECISE POWER METERING

Small enough to fit behind any wall switch or wall socket, **Shelly Plus 1PM** is designed for retrofit applications and can be installed in less than 10 minutes. From automatization of the lights to electrical appliances control, Shelly Plus 1PM provides precise power metering and free cloud data storage.

### TRACK THE POWER CONSUMPTION

Shelly Plus 1PM has an integrated precise power meter that allow you to measure the power consumption and features free data storage for analysis.



### HEATING CONTROL ON SCHEDULE

Set Shelly Plus 1PM to turn on the heating appliances in your house an hour before you come from work. Remotely monitor the power consumption of your heaters to make sure they're running and warming up.



### APPLIANCES AUTOMATION

Get precise measurement of the power consumption of your home appliances and switch them on/off remotely, no matter where you are.



#### Power metering with data storage

Provides precise monitoring of the power consumption.



#### Wi-Fi operated

Connect Shelly Plus 1 PM to your Wi-Fi network.



#### Bluetooth

Add devices quickly and easily via Bluetooth connection, using Shelly Cloud App.



#### Extremely fast processor

For immediate command execution and notification



#### Enhanced safety

Over-temperature protection for prevention of failures.



#### Enhanced security

MQTT and WSS support, TLS certificate support and management for a broad range of use cases.



#### Improved API interface

Broad range of cloud connections and local integrations.



#### No hub required

Control directly without a hub through your smartphone with Shelly Cloud App



#### Highly compatible

Use with your preferred home automation platforms and voice assistants.

### TECHNICAL SPECIFICATIONS

<b>Power supply</b>	<ul style="list-style-type: none"> <li>• 110-240 VAC, 50/60 Hz</li> <li>• 24-30 VDC</li> </ul>
<b>Max load</b>	16 A
<b>Complies with EU standards:</b>	<ul style="list-style-type: none"> <li>• RE Directive 2014/53/EU</li> <li>• LVD 2014/35/EU</li> <li>• EMC 2014/30/EU</li> <li>• RoHS2 2011/65/EU</li> </ul>
<b>Working temperature</b>	-20°C ÷ 40°C
<b>Max RF output power</b>	13.38 dBm
<b>Wireless/Wi-Fi Protocol</b>	802.11 b/g/n (2.4 GHz)
<b>Frequency:</b>	2412 - 2472 MHz
<b>Operational range (depending on local conditions)</b>	<ul style="list-style-type: none"> <li>• up to 50 m outdoors</li> <li>• up to 30 m indoors</li> </ul>
<b>Dimensions (HxWxL)</b>	42x37x16 mm
<b>Electrical consumption</b>	< 1.2 W
<b>Wire cross section range</b>	0.5 ÷ 1.5 mm <sup>2</sup>

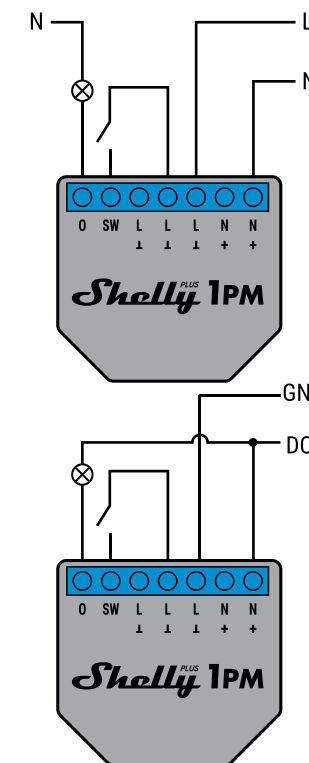

#### Legend

##### Terminals:

- N:** Neutral terminal
- L:** Live (110-240 V) terminal
- O:** Output terminal
- SW:** Switch terminal
- +**: DC positive terminal
- : DC ground terminal

##### Wires:

- N:** Neutral wire
- L:** Live (110-240 V) wire
- GND:** DC ground wire
- DC+:** DC positive (24-30 V) wire

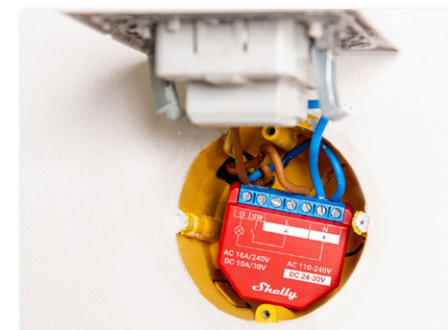



# Shelly PLUS 2PM



## CURTAINS THAT FOLLOW YOUR SCHEDULE

Use the "Schedules" function to create the perfect morning/evening routines by setting Shelly Plus 2PM to open/close the curtains in your home at pre-set hours every day.

## AWNING THAT FOLLOWS THE FORECAST

Set Shelly Plus 2PM to close your garden awning in case of a strong wind to prevent it from breaking.



## CONTROL 2 LIGHTS WITH ONE DEVICE

Shelly Plus 2PM allows you to control and monitor two different circuits, measuring their consumption separately.

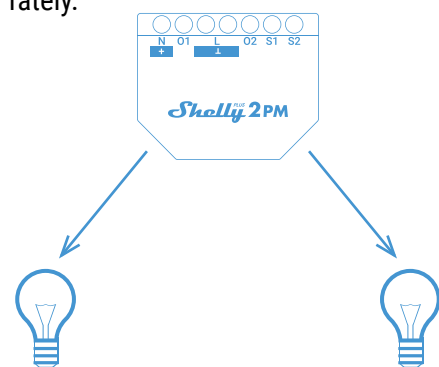

### Wi-Fi operated

Connect Shelly Plus 2PM to your Wi-Fi network. No HUB required.



### Bluetooth

Add devices quickly and easy via Bluetooth connection, using Shelly Cloud App.



### Power metering with data storage

Provides precise monitoring of the power consumption.



### Cover (roller) and position control

Control two-directional AC motors and set your desired position.



### Wide range of voltage support

Can be powered by 110-240V AC & 24V DC, and supports up to 10A per channel and 16A total.



### Extremely fast processor

For immediate command execution and notification.



### Enhanced safety

Over-temperature protection for prevention of failures.



### Enhanced security

MQTT and WSS support, TLS and custom certificates support for a broad range of use cases.



### Improved API interface

Broad range of cloud connections and local integrations.



### No hub required

Control directly and without a hub through your smartphone with Shelly Cloud App.



### Highly compatible

Use with your preferred home automation platforms and voice assistants.

## NEXT GENERATION 2-CHANNEL RELAY WITH COVER AND POSITION CONTROL

Shelly Plus 2PM allows automation of roller shutters, blinds, curtains, awnings, gates, and any bi-directional AC motors. Two integrated precise power meters allow you to measure the consumption for each channel separately. Shelly Plus 2PM has scripting functionalities for customized features and even more intuitive automation.

### TECHNICAL SPECIFICATIONS

<b>Power supply</b>	<ul style="list-style-type: none"> <li>• 110-240 VAC, 50/60Hz</li> <li>• 24 VDC ±10%,</li> </ul>
<b>Max load per channel</b>	10 A
<b>Max. device load</b>	16 A
<b>Complies with EU standards:</b>	<ul style="list-style-type: none"> <li>• RE Directive 2014/53/EU</li> <li>• LVD 2014/35/EU</li> <li>• EMC 2014/30/EU</li> <li>• RoHS2 2011/65/EU</li> </ul>
<b>Working temperature</b>	-20°C ÷ 40°C
<b>Max RF output power</b>	20 dBm
<b>Wireless/Wi-Fi Protocol</b>	802.11 b/g/n (2.4 GHz)
<b>Frequency:</b>	2412 - 2472 MHz
<b>Operational range (depending on local conditions)</b>	<ul style="list-style-type: none"> <li>• up to 50 m outdoors</li> <li>• up to 30 m indoors</li> </ul>
<b>Dimensions (HxWxL)</b>	42x37x16 mm
<b>Electrical consumption</b>	< 1,4 W
<b>Wire cross section range</b>	0.5 ÷ 1.5 mm <sup>2</sup>

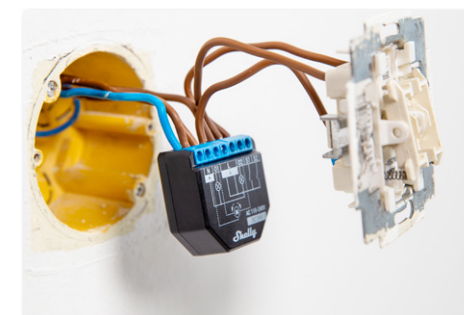

### USE SHELLY PLUS 2PM TO AUTOMATE:

- ✓ Blinds
- ✓ Roller Shutters
- ✓ Curtains
- ✓ Awnings
- ✓ Garage Doors
- ✓ Lights

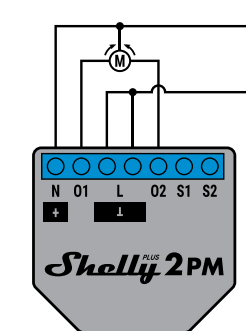
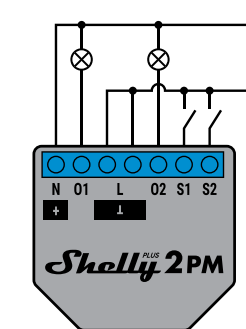
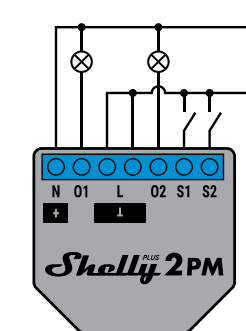

### Legend

#### Device terminals:

- O1:** Load circuit 1 output terminal
- O2:** Load circuit 2 output terminal
- S1:** Switch (controlling O1) input terminal
- S2:** Switch (controlling O2) input terminal
- L:** Live (110-240 VAC) terminals
- N:** Neutral terminal
- +**: 24 VDC positive terminal
- : 24 VDC negative terminal
- Wires:**
- N:** Neutral wire
- L:** Live (110-240 VAC) cable
- +**: 24 VDC positive wire
- : 24 VDC negative wire

# Shelly PLUS i4

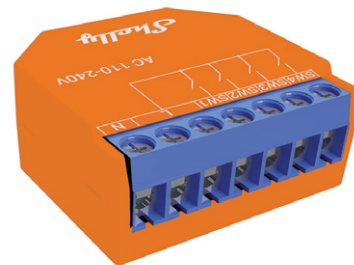

## SMART SCENES ACTIVATION WITH ENHANCED CONTROL

Shelly Plus i4 allows customers to manually activate or deactivate any created scene, run synchronized actions, or execute complex trigger scenarios. Shelly Plus i4 can control other connected Shelly relays, sensors, or HTTP and MQTT-controlled devices. Thanks to its small dimensions, it can fit behind every wall switch.

### COMPLEX SCENE ACTIVATION

Manually activate or deactivate complex scenes. With Shelly Plus i4 you can run synchronized actions of several Shelly devices. You can install Shelly Plus i4 close to the front door of your home and turn off/on all the lights in your house with one push of the button, saving you time when you are in a hurry.



### MANUAL CONTROL OF OTHER SHELLEY DEVICES



#### Wi-Fi operated

Connect Shelly Plus i4 directly to your Wi-Fi network.



#### Bluetooth

Add devices quickly and easy via Bluetooth connection, using Shelly Cloud App



#### Wide range of voltage support

Shelly Plus i4 can be powered by 110-240 V AC



#### Multi-actions support

Up to 12 possible actions.



#### Extremely fast processor

For immediate command execution and notification



#### Enhanced security

MQTT and WSS support, TLS and custom certificates support for a broad range of use cases.



#### Improved API interface

Broad range of cloud connections and local integrations.



#### No hub required

Control directly and without a hub through your smartphone with Shelly Cloud App.



#### Highly compatible

Use with your preferred home automation platforms and voice assistants

### TECHNICAL SPECIFICATIONS

<b>Power Supply</b>	• 110-240 VAC, 50/60 Hz
<b>Multi-click support</b>	Up to 12 possible actions (3 per button)
<b>Complies with EU standards</b>	• RE Directive 2014/53/EU • LVD 2014/35/EU • EMC 2014/30/EU • RoHS2 2011/65/EU
<b>Working temperature</b>	-20°C ÷ 40°C
<b>Max RF output power</b>	14.9 dBm
<b>Radio protocol</b>	Wi-Fi 802.11 b/g/n
<b>Frequency:</b>	2412 - 2472 MHz
<b>Operational range (depending on local conditions)</b>	• up to 50 m outdoors • up to 30 m indoors
<b>Dimensions</b>	42x37x16 mm
<b>Electrical consumption</b>	< 1mW
<b>Wire cross section range</b>	0.5 ÷ 1.5 mm <sup>2</sup>

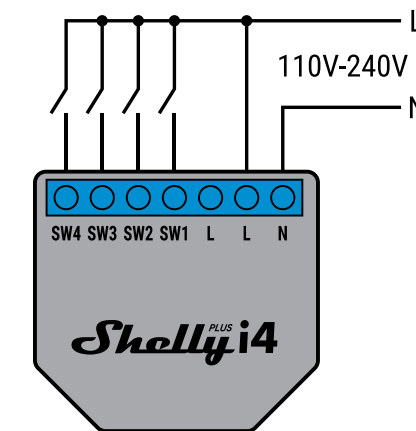

#### Legend

##### Terminals:

- N: Neutral terminal
- L: Live (110-240V) terminal
- SW1: Switch terminal
- SW2: Switch terminal
- SW3: Switch terminal
- SW4: Switch terminal
- Wires:
- N: Neutral wire
- L: Live (110-240V) wire



### Smart Bulbs control like never before

Whether you use Shelly Wi-Fi bulbs or different brands smart bulbs, Shelly Plus i4 is highly compatible and can control them all! Furthermore, you can use Shelly Plus i4 to set the light color you want or for dimming of your smart bulbs. All you have to do is add and configure one of our scripts or webhooks created specifically for Shelly Plus i4

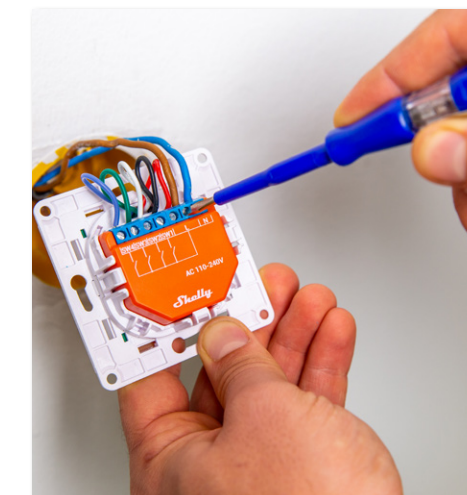



# Shelly PLUS H&T



## NEXT GENERATION TEMPERATURE & HUMIDITY SENSOR

With over 1 year of battery life, **Shelly Plus H&T** will make sure that you are always aware of the levels of humidity and temperature in your home. Enhanced with a faster processor, and a low-consuming e-ink display, Shelly Plus H&T will monitor even the slightest change in the conditions and help you prevent dryness or mold while maintaining comfortable conditions at the premises.

### MONITOR THE HUMIDITY LEVELS IN YOUR HOME



### MONITOR THE TEMPERATURE OF YOUR HEATER OR AIR CONDITIONER



### COMPATIBLE WITH OTHER DEVICES

Reveal the full potential of Shelly Plus H&T to by combining it with other smart devices in your home network and customize the actions based on the day, hour, or various actions.



#### Wi-Fi operated

Connect Shelly Plus H&T to your Wi-Fi network. No HUB required!



#### Bluetooth inclusion

Add devices quickly and easily via Bluetooth connection, using Shelly Cloud App.



#### Extremely fast processor

Shelly Plus H&T will report any change in the humidity or temperature levels and will send immediate notification.



#### E-ink display

Enhanced with a low-consuming e-ink display, Shelly Plus H&T will keep you up to date with the temperature and humidity levels



#### Humidity

Monitor excessive changes in humidity. Avoid dryness and conditions for mold growth.



#### Temperature

Be aware of temperature fluctuations and keep your home comfortable at any time.



#### Battery

Battery life up to 18 months. Works with 4 x Regular 1.5 V AA (LR) batteries (not included in the package)



#### USB Power Supply

Shelly Plus H&T is enhanced with Type-C USB slot for faster connection and more frequent reporting to the app.



#### Free history on Cloud

With Shelly Plus H&T you can see recorded data for humidity and temperature for up to a year.

### TECHNICAL SPECIFICATIONS

<b>Battery</b>	4 x Regular 1.5 V AA (LR) batteries ( <b>NOT</b> included)
<b>Battery life</b>	Up to 18 months
<b>Humidity measurement range:</b>	0 ÷ 100%
<b>Measurement accuracy</b>	± 1°C
<b>Working temperature</b>	0°C ÷ 40°C
<b>Max RF output power</b>	15 dBm
<b>Wireless/Wi-Fi Protocol</b>	802.11 b/g/n (2.4 GHz)
<b>Frequency</b>	2412 - 2472 MHz
<b>Operational range (depending on local conditions)</b>	<ul style="list-style-type: none"> <li>• up to 50 m outdoors</li> <li>• up to 30 m indoors</li> </ul>
<b>Dimensions (HxWxL)</b>	70x70x26 mm (without stand) 70x70x45 mm (with stand)
<b>Complies with EU standards:</b>	<ul style="list-style-type: none"> <li>• RE Directive 2014/53/EU</li> <li>• LVD 2014/35/EU</li> <li>• EMC 2014/30/EU</li> <li>• RoHS2 2011/65/EU</li> </ul>

### HEATING/COOLING OPTIMIZATION

With Shelly H&T you can **optimize the power consumption** for heating and cooling of your home.

### HUMIDITY CONTROL

**Humidity control** is very important for your health. Keep it at its optimal levels with Shelly Plus H&T.

### PRECISE INFORMATION NO MATTER WHERE YOU ARE

Stay informed about the humidity and temperature levels of your home no matter where you are and control them remotely through the app.

### NO HUB REQUIRED!

Shelly Plus H&T can be controlled directly and without a hub through your smartphone with Shelly Cloud App.

### MAKE YOUR BATHROOM FAN SMART!

Automate your bathroom fan using Shelly Plus 1! Place Shelly Plus H&T in your bathroom and set it to switch on the fan once the levels of humidity increase. That way you never again have to worry about forgetting to switch off the fan once you leave the shower!



# Shelly PLUS Smoke



## BE ALWAYS ALERTED, NO MATTER WHERE YOU ARE!

Provide additional protection for your home, family, and pets with Shelly Plus Smoke. Monitor your home for any smoke, wherever you are, thanks to its long life span, high sensitivity, and Wi-Fi technology.

## IMMEDIATE NOTIFICATIONS

Shelly Plus Smoke will immediately inform you and your family members in real-time in case of any detected danger and allow you to take action.

## LOCAL CONTROL OF ALL YOUR DEVICES

Shelly Plus Smoke Alarm can execute direct actions on other devices on your local network without being connected to the Internet or Shelly Cloud.



### Wi-Fi operated

Connect Shelly Plus Smoke to your Wi-Fi network. No HUB required



### Bluetooth connectivity

Easily add Shelly Plus Smoke to your Shelly app account.



### 3 year of battery life

Low-battery-consuming technology.



### Sound & light alerts

If smoke is detected, Shelly Plus Smoke will initiate a loud sound (>85db) and light alarm.



### Easily mountable

Shelly Plus Smoke is wire-free and has no angle limitations.



### Immediate notification

No matter where you are, Shelly Plus Smoke will immediately notify you of any danger.



### Smart scenes

Set custom scenes by combining Shelly Plus Smoke with your other Shelly devices.



### No hub required

Control directly and without a hub through your smartphone with Shelly Cloud App.



### Highly compatible

Use with your preferred home automation platforms and voice assistants.

## SMART WI-FI SMOKE ALARM

Shelly Plus Smoke Alarm is a smart photoelectric smoke alarm, which is effective at detecting slow fires that smolder for hours before bursting into flame. Receive instant notifications on your phone and create safety scenes to keep your family and home safe.

### TECHNICAL SPECIFICATIONS

<b>Battery</b>	1x 3 V CR123A battery
<b>Battery life</b>	3 year
<b>Humidity</b>	30 % to 95 % RH
<b>Weight w/o battery</b>	95 g
<b>Working temperature</b>	0°C ÷ 55°C
<b>Max RF output power</b>	20 dBm
<b>Wireless/Wi-Fi Protocol</b>	802.11 b/g/n (2.4 GHz)
<b>Frequency</b>	2412 - 2472 MHz
<b>Operational range (depending on local conditions)</b>	<ul style="list-style-type: none"> <li>• up to 50 m outdoors</li> <li>• up to 30 m indoors</li> </ul>
<b>Dimensions (HxWxL)</b>	86x86x31mm





# Shelly <sup>PLUS</sup> Plug S



## AVOID ENERGY WASTE WITH SMART SCHEDULES

Cut the energy consumption in half with Shelly Plus Plug S and reduce monthly energy costs by automating appliances in the office that are not used at night or over the weekend.



WHEN



From 07:00PM - To 7:00 AM

THEN



Shelly Plus Plug S  
Switch off Water dispenser

## MILDLY DIMMED NIGHT LIGHT FOR CHILDREN'S COMFORT

Use Shelly Plus Plug S LED indication as subtle light for the kids' room at night – just set the colour and the level of glow.



### Wi-Fi operated

Connect Shelly Plus Plug S to your Wi-Fi network. No HUB required!



### Bluetooth connectivity

Easily add Shelly Plus Plug S to your Shelly app account.



### Wide variety of appliances supported

Use it to control a wide range of devices and appliances (up to 12 A)



### Power Monitoring

Shelly Plus Plug S provides precise monitoring of power consumption.



### 3 LED indication modes

Use Shelly App to adjust the brightness of the LED ring according to your preferences in all modes.



### Custom schedules

Set custom schedules based on your daily agenda or automatically follow the sunrise/sunset and control your appliances accordingly.



### Smart scenes

Set custom scenes by combining Shelly Plus Plug S with your other Shelly devices.



### URL actions

Let Shelly Plus Plug S directly control or get controlled by other smart devices.



### No hub required

Control directly and without a hub through your smartphone with Shelly Cloud App.



### Highly compatible

Use with your preferred home automation platforms and voice assistants

## NEXT-GENERATION WI-FI OPERATED PLUG

Shelly Plus Plug S is a small, but powerful Wi-Fi smart plug with Bluetooth connectivity and power metering, that will monitor and control lighting, heating, or any other connected electrical appliance with a power rating of up to 2500 W at home.

### TECHNICAL SPECIFICATIONS

<b>Power supply</b>	Input 110-230 VAC, 50/60 Hz
<b>Max load</b>	12 A / 230 V
<b>Complies with EU standards</b>	<ul style="list-style-type: none"> <li>• RE Directive 2014/53/EU</li> <li>• LVD 2014/35/EU</li> <li>• EMC 2014/30/EU</li> <li>• RoHS2 2011/65/EU</li> </ul>
<b>Working temperature</b>	-20°C ÷ 40°C
<b>Max RF output power</b>	20 dBm
<b>Wireless/Wi-Fi Protocol</b>	802.11 b/g/n (2.4 GHz)
<b>Frequency</b>	2412 - 2472 MHz
<b>Operational range (depending on local conditions)</b>	<ul style="list-style-type: none"> <li>• up to 50 m outdoors</li> <li>• up to 30 m indoors</li> </ul>
<b>Dimensions (HxWxL)</b>	44x44x70 mm
<b>Processor (CPU)</b>	ESP32
<b>Remote Control</b>	Trough mobile app & web interface
<b>Compatibility</b>	Android (4.2+) & iOS (8+), web browsers
<b>Languages</b>	Multiple trough mobile app & web interface
<b>Electrical consumption</b>	< 1 W

### POWER CONSUMPTION LED INDICATION

When set to "Power consumption" mode, Shelly Plus Plug S will indicate the power consumption by a smooth color change from green for 0%, yellow for 50% and red for 100% of the power limit.

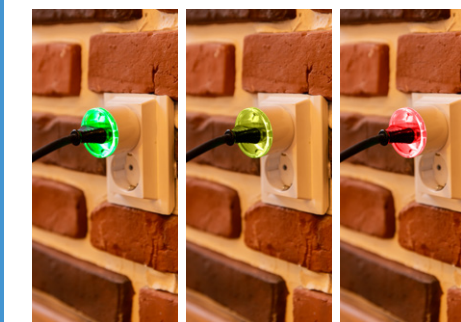

0 W      1250 W      2500 W  
50%      100%

### ADJUSTABLE LED LIGHT

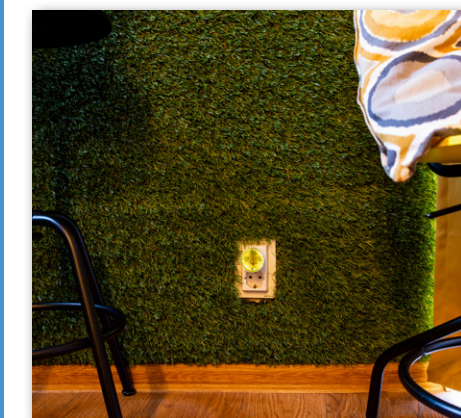

# Shelly <sup>PLUS</sup> Plug UK



## NEXT-GENERATION WI-FI OPERATED PLUG (UK STANDARD)

Shelly Plus Plug UK is a Wi-Fi smart plug with Bluetooth connectivity, 3 customizable LED indication modes, and power metering. It can automatically monitor and control lighting, heating, or any other connected electrical appliance at home with power up to 2300W.

### FORECAST AND OPTIMIZE YOUR UTILITY EXPENSES

Use the integrated precise power meter of Shelly Plus Plug UK and monitor the real-time energy consumption of all switched-on devices to optimize your expenses.

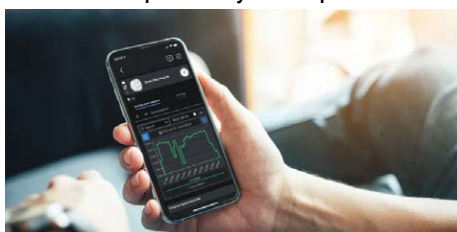

### PREVENT APPLIANCES DAMAGES

You can set Shelly Plus Plug UK to inform you about any damaged electrical appliance, which has increased the amount of energy used in an attempt to compensate for its operational capacity.



### ALEXA, TURN ON THE "CHILL TIME" SCENE!

Are you ready for some relaxing time after a long day at work? Just say so and Shelly will make it happen!

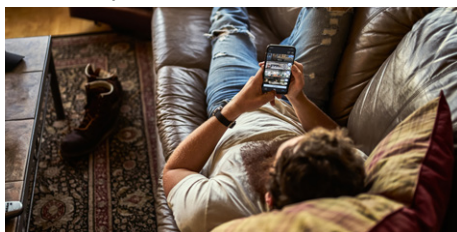

#### Wi-Fi operated

Connect Shelly Plus Plug UK to your Wi-Fi network. No HUB required!



#### Bluetooth connectivity

Easily add Shelly Plus Plug UK to your Shelly app account.



#### Wide variety of appliances supported

Use it to control a wide range of devices and appliances (up to 12 A)



#### Power Monitoring

Shelly Plus Plug UK provides precise monitoring of power consumption.



#### 3 LED indication modes

Use Shelly App to adjust the brightness of the LED ring according to your preferences in all modes.



#### Custom schedules

Set custom schedules based on your daily agenda or automatically follow the sunrise/sunset and control your appliances accordingly.



#### Smart scenes

Set custom scenes by combining Shelly Plus Plug UK with your other Shelly devices.



#### Scripting functionalities

Shelly Plus Plug UK fully supports mJS scripting, allowing you to create further features and functionalities.



#### URL actions

Let Shelly Plus Plug UK directly control or get controlled by other smart devices.



#### No hub required

Control directly and without a hub through your smartphone with Shelly Cloud App.



#### Highly compatible

Use with your preferred home automation platforms and voice assistants

### TECHNICAL SPECIFICATIONS

<b>Power supply</b>	Input 110-230 VAC, 50/60 Hz
<b>Max load</b>	12 A / 230 V
<b>Complies with EU standards</b>	<ul style="list-style-type: none"> <li>• RE Directive 2014/53/EU</li> <li>• LVD 2014/35/EU</li> <li>• EMC 2014/30/EU</li> <li>• RoHS2 2011/65/EU</li> </ul>
<b>Working temperature</b>	-20°C ÷ 40°C
<b>Max RF output power</b>	20 dBm
<b>Wireless/Wi-Fi Protocol</b>	802.11 b/g/n (2.4 GHz)
<b>Frequency</b>	2412 - 2472 MHz
<b>Operational range (depending on local conditions)</b>	<ul style="list-style-type: none"> <li>• up to 50 m outdoors</li> <li>• up to 30 m indoors</li> </ul>
<b>Dimensions (HxWxL)</b>	60x60x56 mm
<b>Processor (CPU)</b>	ESP32
<b>Remote Control</b>	Trough mobile app & web interface
<b>Compatibility</b>	Android (4.2+) & iOS (8+), web browsers
<b>Languages</b>	Multiple trough mobile app & web interface
<b>Electrical consumption</b>	< 1 W

### POWER CONSUMPTION LED INDICATION

When set to "Power consumption" mode, Shelly Plus Plug UK will indicate the power consumption by a smooth color change from green for 0%, yellow for 50% and red for 100% of the power limit.

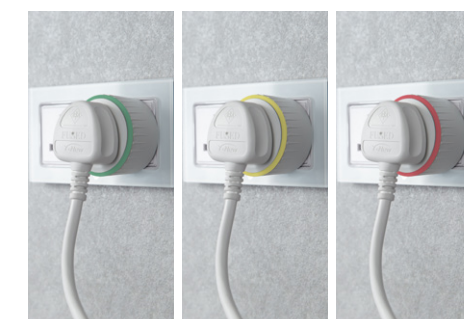

0 W      1250 W      2500 W  
50%      100%



# Shelly PLUS Plug IT



## WI-FI OPERATED PLUG (ITALIAN STANDARD)

Shelly Plus Plug IT is a Wi-Fi smart plug with power metering, that automatically monitors and controls lighting, heating, or any other connected electrical appliance at home with a power rating of up to 2300 W.

### MAKE YOUR OLD SPACE HEATER FOLLOW THE WEATHER

Use Shelly Plus Plug IT's scripting functionalities to automate your old space heater to follow the current weather forecast, so no energy will go to waste.



### NO MORE FORGOTTEN APPLIANCES

Save energy or prevent any possible damage by controlling all plugged-in appliances easily through your phone with Shelly Plus Plug IT.



#### Wi-Fi Operated

Connect Shelly Plus Plug IT to your Wi-Fi network. No HUB required!



#### Bluetooth connectivity

Easily add Shelly Plus Plug IT to your Shelly app account.



#### Wide variety of appliances supported

Use it to control a wide range of devices and appliances (up to 10A)



#### Power Monitoring

Shelly Plus Plug IT provides precise monitoring of the power consumption.



#### Custom schedules

Set custom schedules based on your daily agenda or automatically follow the sunrise/sunset and control your appliances accordingly.



#### Smart scenes

Set custom scenes by combining Shelly Plus Plug IT with your other Shelly devices.



#### Countdown timer

An integrated countdown timer for pre-set actions - switch on/off.



#### URL actions

Let Shelly Plus Plug IT directly control or get controlled by other smart devices.



#### No hub required

Control directly and without a hub through your smartphone with Shelly Cloud App.



#### Highly compatible

Use with your preferred home automation platforms and voice assistants

### TECHNICAL SPECIFICATIONS

<b>Power supply</b>	Input 230 VAC, 50/60 Hz
<b>Max load</b>	10 A / 230 V
<b>Complies with EU standards</b>	<ul style="list-style-type: none"> <li>• RE Directive 2014/53/EU</li> <li>• LVD 2014/35/EU</li> <li>• EMC 2014/30/EU</li> <li>• RoHS2 2011/65/EU</li> </ul>
<b>Working temperature</b>	-20°C ÷ 40°C
<b>Max RF output power</b>	20 dBm
<b>Wireless/Wi-Fi Protocol</b>	802.11 b/g/n (2.4 GHz)
<b>Frequency</b>	2412 - 2472 MHz
<b>Operational range (depending on local conditions)</b>	<ul style="list-style-type: none"> <li>• up to 50 m outdoors</li> <li>• up to 30 m indoors</li> </ul>
<b>Dimensions (HxWxL)</b>	70x70x70 mm
<b>Processor (CPU)</b>	ESP32
<b>Remote Control</b>	Trough mobile app & web interface
<b>Compatibility</b>	Android (4.2+) & iOS (8+), web browsers
<b>Languages</b>	Multiple trough mobile app & web interface
<b>Electrical consumption</b>	< 1 W



# Shelly<sup>®</sup> 1



## WI-FI-OPERATED RELAY SWITCH FOR LIGHTS AND APPLIANCES AUTOMATION

The Wi-Fi Relay Switch Shelly 1 OS is intended to be mounted into a standard in-wall console, behind power sockets and light switches in order to control the electric power through it.

USE THE POWER OF MONGOOSE OS TO MAKE YOUR OWN APPLICATION



MAKE YOUR ARDUINO PROJECT LIVE AND USABLE IN YOUR AUTOMATION PROJECT



SHARE YOUR EXPERIENCE WITH DEVELOPERS OVER THE WORLD



USE OUR REST API TO CONNECT SHELLY 1 OS WITH YOUR EXISTING HOME AUTOMATION SYSTEM



### Mobile App Control

Turn appliances on/off directly from your smartphone or tablet.



### Wi-Fi Connected

Simply connect Shelly to your Wi-Fi network and begin the ultimate experience by controlling your home with your phone.



### Home assistant compatible

Control your appliance with your voice. Shelly 1 OS is Google home and Amazon Echo compatible.



### Weekly Scheduling

Create custom daily schedules for your devices.



### Following the Sunlight

Shelly 1 OS can automatically turn on/off based on the sunrise and sunset hours.



### Up To 3500W

With Shelly 1 OS you can control a wide range of devices and appliances.



### Free Cloud

All you need to manage your Shelly 1 OS is a smartphone and the Shelly Cloud free mobile application.



### Countdown timer

No more forgotten turned on appliances. The integrated countdown timer can automatically switch off your oven after an hour.

### TECHNICAL SPECIFICATIONS

<b>Power supply</b>	<ul style="list-style-type: none"> <li>• 110-240 VAC, 50/60 Hz</li> <li>• 24-60 VDC</li> <li>• 12 VDC ±10%</li> </ul>
<b>Max load</b>	16 A
<b>Complies with EU standards:</b>	<ul style="list-style-type: none"> <li>• RE Directive 2014/53/EU</li> <li>• LVD 2014/35/EU</li> <li>• EMC 2014/30/EU</li> <li>• RoHS2 2011/65/EU</li> </ul>
<b>Working temperature</b>	-20°C ÷ 40°C
<b>Max RF output power</b>	9.95 dBm
<b>Wireless/Wi-Fi Protocol</b>	802.11 b/g/n (2.4 GHz)
<b>Frequency:</b>	2412 – 2472 MHz
<b>Operational range (depending on local conditions)</b>	<ul style="list-style-type: none"> <li>• up to 50 m outdoors</li> <li>• up to 30 m indoors</li> </ul>
<b>Dimensions (HxWxL)</b>	43x38x18 mm
<b>Electrical consumption</b>	< 1 W
<b>Wire cross section range</b>	0.5 ÷ 1.5 mm <sup>2</sup>

fig.1 Power supply: 110-240V AC

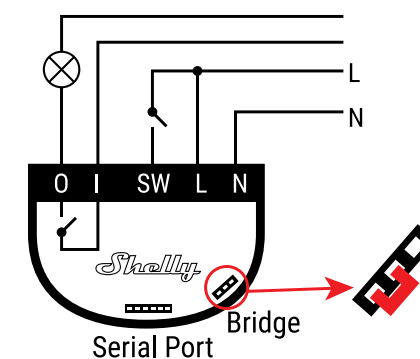
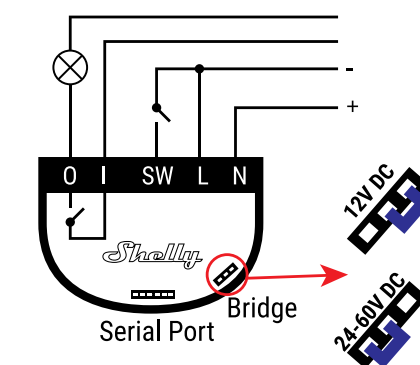

fig.2 Power supply: 12V; 24-60V DC



- Legend**
- Device terminals:**
- O: Load circuit output terminal
  - I: Load circuit input terminal
  - SW: Switch (controlling O) input terminal
  - L: Live (110-240 VAC) terminal
  - N: Neutral terminal
- Wires:**
- L: Live (110-240 VAC) wire
  - N: Neutral wire
  - : 12/24-60 VDC negative wire
  - +: 12/24-60 VDC positive wire

The Wi-Fi Relay Switch Shelly 1 may control an electrical circuit up to 16A. It is intended to be mounted into a standard in-wall console, behind power sockets and light switches or other places with limited space. Shelly may work as a standalone Device or as an accessory to a home automation controller.



# Shelly<sup>®</sup> dimmer2

## SMALL SIZE FULL OF FUNCTIONALITIES



Intelligently designed to fit in most standard electrical boxes and switches. Shelly Dimmer 2 is a tiny device offering an array of dimming functionalities.



### No additional controller

Shelly Dimmer 2 uses your home Wi-Fi network, no additional controllers are needed.



### On/off and dimming function

With Shelly Dimmer 2 you can turn on/off or use dimming function to set your lights to your preference.



### Overheating protection

Internal temperature sensor for overheating protection.



### Support 100-240V~ 50/60Hz

With Shelly Dimmer 2 you can use incandescent and halogen lights: 10-220W, dimmable LED lights: 50-200VA / 10W – 200W or resistive-inductive loads: ferromagnetic transformers 50-150VA.



### Free Cloud

All you need to manage your Shelly Dimmer 2 is a smartphone and the Shelly Cloud free mobile application.

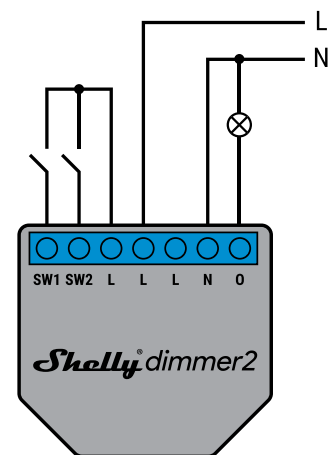

Standard wiring with neutral

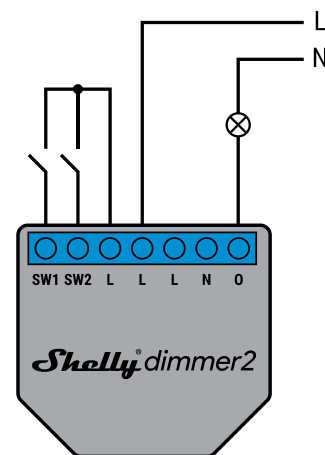

No neutral wiring

## CREATE THE PERFECT HOME ATMOSPHERE THAT SUITS YOUR MOOD

Dimming without a neutral line. We developed Shelly Dimmer 2 to be able to cover all possible electrical installations all over the world. Shelly Dimmer 2 can be used in houses where the neutral line is missing and provide a full set of dimming functionalities.

## TECHNICAL SPECIFICATIONS

<b>Power Supply</b>	110-230 VAC, 50/60 Hz
<b>Can work without neutral line</b>	Yes
<b>Complies with EU standards</b>	<ul style="list-style-type: none"> <li>• RE Directive 2014/53/EU</li> <li>• LVD 2014/35/EU</li> <li>• EMC 2014/30/EU</li> <li>• RoHS2 2011/65/EU</li> </ul>
<b>Working temperature:</b>	0 ÷ 35°C
<b>Max RF output power</b>	13 dBm
<b>Radio protocol</b>	Wi-Fi 802.11 b/g/n
<b>Frequency</b>	2412 - 2472 MHz
<b>Operational range (depending on local conditions)</b>	<ul style="list-style-type: none"> <li>• up to 50 m outdoors</li> <li>• up to 30 m indoors</li> </ul>
<b>Dimensions</b>	43x37x14 mm
<b>Electrical consumption</b>	< 1 W
<b>Wire cross section range</b>	0.5 ÷ 1.5 mm <sup>2</sup>

## Use with any bulb you want

Shelly Dimmer 2 can be used with a variety of light bulbs. From halogen and incandescent lights to dimmable LED and resistive - inductive load ferromagnetic transformers.

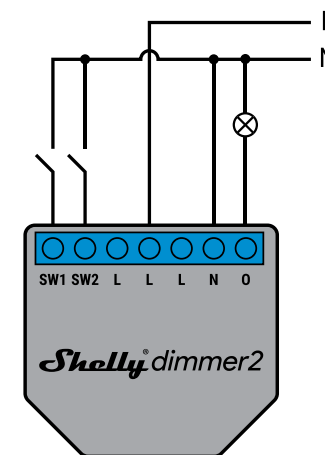
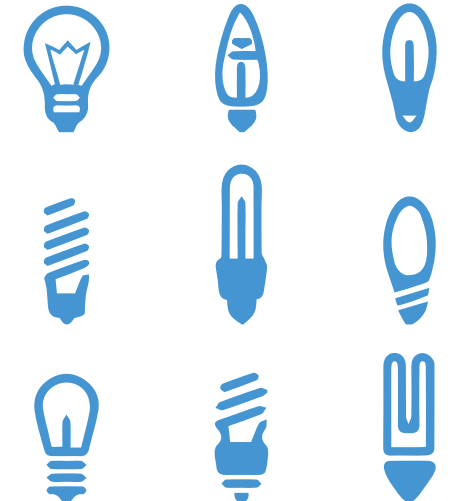

Standard wiring with neutral and SW connected to neutral

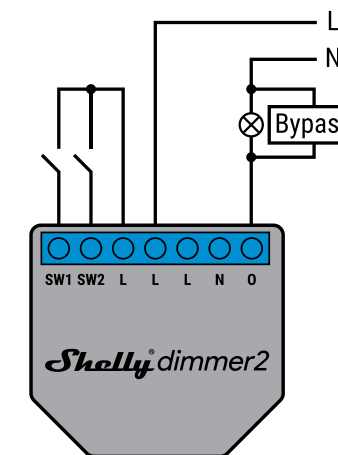

No neutral wiring with no minimum load requirements

### Legend

#### Device terminals:

- SW1:** Switch 1 input terminal
- SW2:** Switch 2 input terminal
- L:** Live (110-240 VAC) terminals
- N:** Neutral terminal
- O:** Load circuit output terminal

#### Wires:

- L:** Live (110-240 VAC) wire
- N:** Neutral wire

# Shelly® RGBW2



## POWER ON



Get a 110–220 VAC to 12-24 VDC

## SHELLY RGBW2



Connect Shelly RGBW2 to the power transformer

## LED STRIPS AND/OR BULBS



Support any 12V or 24 V White, RGB, RGBW led strips and 12/24 V led bulbs, with up to 288 W combined power



### Wireless

No HUB required – Connect Shelly RGBW2 directly to your Wi-Fi at home.



### Weekly Schedules

Choose a time and set your hidden lighting to turn on/off or change color.



### Sunrise/Sunset Schedules

Shelly RGBW will automatically follow the sunrise and sunset and can control your lighting accordingly.



### Color Effects

The 6 unique colorful effects will set the mood for your party or help you relax at home.



### Control Remotely

Control the LED lighting at home, no matter where you are. Now you won't be leaving the lights on and your home won't welcome you in darkness.



### Highly Compatible

Compatible with Android, iOS, Amazon Alexa and Google Assistant.



### Support 12V or 24V

With Shelly RGBW2 you can use White, RGB, RGBW led strips and 12/24V led bulbs, with up to 288W combined power.



### ON/OFF and Dimming Function

No more forgotten turned on appliances. The integrated countdown timer can automatically switch off your lights after an hour.

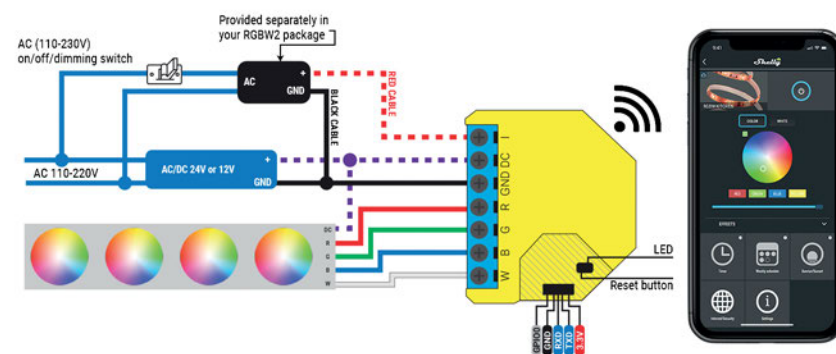

## WI-FI RGBW LED CONTROLLER

Make your LED strips smart without additional investment. **Shelly RGBW2** connects like any LED controller. The main benefit is that you will be able to control your light directly from your mobile phone.

## TECHNICAL SPECIFICATIONS

Interfaces	
<b>Output interface</b>	4 ways PWM: R/G/B/W 3 ways PWM: R/G/B 4 ways PWM: 4x White strips or 4x12/24 V LED bulbs
<b>Interface</b>	Reset button, AC 230 V switch input
<b>AC switch</b>	On/Off and Dimming function
Wi-Fi Parameters and Features	
<b>Wi-Fi work mode</b>	STA/AP/STA+AP/Smart Config
<b>Security Specialty</b>	None, WEP, WPA-PSK, WPA2-PSK (TKIP/AES)
<b>Wi-Fi Standard</b>	IEEE 802.11b/g/n
<b>Wi-Fi Power</b>	802.11b (CCK) 11 Mbps: 20+/-1.5 dBm
	802.11g (OFDM) 54 Mbps: 15.5+/-1.5 dBm
	802.11n(HT20@MCS7) 72.2 Mbps: 14.5+/-1.5 dBm
<b>Frequency</b>	2.4GHz-2.5GHz (2400M-2483.5M)
<b>Antenna</b>	Embedded
Power Input/output	
<b>DC Power Input</b>	12-24 V
<b>DC Power Output 12V</b>	144 W - combined power; 45 W - per channel
<b>DC Power Output 24V</b>	288 W - combined power; 90 W - per channel
<b>Standby Current</b>	≤50 mA
Work environment	
<b>Working temperature</b>	-20°C ÷ 40°C
<b>Work humidity</b>	5% to 95% (No condensing)
<b>Wi-Fi Range</b>	Indoor: 35m, Outdoor: 60m (depending on the environment)
<b>Dimensions (HxWxL)</b>	43x38x14 mm
<b>Wire cross section range</b>	0.5 ÷ 1.5 mm <sup>2</sup>

- Focus on 8~36 W lamps such as droplight, ceiling lamp, table lamp, down lamp or other
- Support 5 ways PWM, applied to control 5 colors LED(R/G/B/CW/WW),
- Offers mobile phone App, supporting iOS and Android
- Configure network via the mobile App
- Supports local and remote control
- Supports Weekly Schedules
- Supports Sunrise/Sunset time based Schedules
- 6 color effects

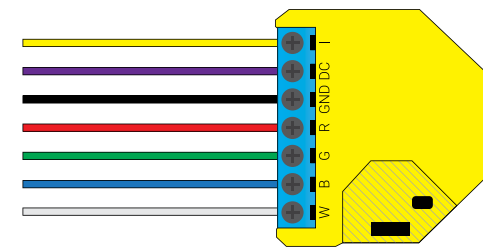

### Legend

- AC or DC on/off/dimming switch
- + 12/24 VDC
- - 12/24 VDC
- Red Light
- Green Light
- Blue Light
- White Light



# Shelly<sup>®</sup> 1L



## SUPPORTED LOAD TYPE (WITH AND WITHOUT NEUTRAL):

- ✓ Resistive (lights, electric heaters)
- ✓ Inductive (Led Lights, Transformers, Fan, Motors)
- ✓ Capacitive (motor starting capacitors, generators, and synchronous motors)

## SUPPORTED LIGHT TYPES:

- ✓ Incandescent lamps
- ✓ Fluorescent lamps.
- ✓ Halogen lamps.
- ✓ Dimmable LED
- ✓ Fluorescent tubes
- ✓ Neon lamps.



### Wi-Fi Connected

No HUB required – Connect Shelly 1L directly to your Wi-Fi at home



### No neutral required

Power on the device and control your light, fan, or other appliances only by Live wire, no neutral required to be connected to the device.



### Highly compatible

Compatible with Android, iOS, Amazon Alexa and Google Assistant. Control your appliance with your voice.



### Overheating protection

In case of high temperature Shelly1L will switch OFF the output to protect itself and your home appliances.



### Following the Sunlight

Shelly 1L can automatically follow the sunrise and sunset and control your lighting accordingly.



### Weekly Scheduling

Choose a time and set your lighting to turn on/off or dim precisely when you want it to.



### Rest API

Use our REST API to connect Shelly 1L to your existing home automation system.



### MQTT enabled

Easily integrate Shelly1L to your existing home server using MQTT or CoAP protocol.

## DEVICE PINOUT

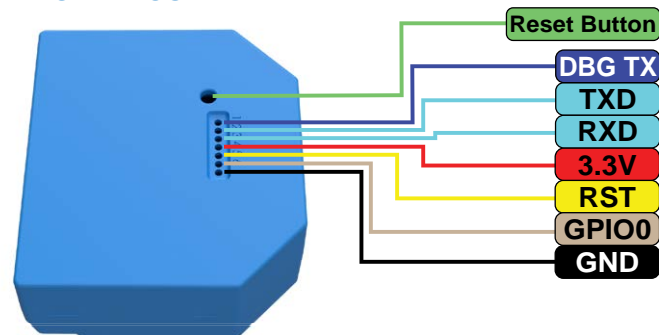

## THE BEST RETROFIT DEVICE EVER MADE

**No electrical wiring changes needed** Shelly1L can convert any existing wall into a smart switch. You don't need to change the wiring, to run new cables, or anything else. Just put the shelly behind the existing wall switch.

**No neutral line required.** Many light switches are wired with no neutral present, which makes them difficult to automate. Shelly1L handles this problem because it only needs the hot line.

## TECHNICAL SPECIFICATIONS

<b>Power supply</b>	110-230 VAC, 50/60 Hz
<b>Power supply DC</b>	No
<b>Device temperature protection</b>	Yes
<b>Complies with EU standards:</b>	<ul style="list-style-type: none"> <li>• RE Directive 2014/53/EU</li> <li>• LVD 2014/35/EU</li> <li>• EMC 2014/30/EU</li> <li>• RoHS2 2011/65/EU</li> </ul>
<b>Working without a neutral line</b>	Yes
<b>Channels</b>	1
<b>Maximum load</b>	4.1 A (5 A for short operation)
<b>Minimum load – no neutral connected, without bypass</b>	20 W resistive load
<b>Operational temperature</b>	-20°C ÷ 40°C
<b>Device power consumption</b>	< 1 W
<b>Wireless/Wi-Fi Protocol</b>	802.11 b/g/n (2.4 GHz)
<b>Frequency</b>	2412 - 2472 MHz
<b>Max RF output power</b>	12.24 dBm
<b>Operational range (depending on local conditions)</b>	<ul style="list-style-type: none"> <li>• up to 50 m outdoors</li> <li>• up to 30 m indoors</li> </ul>
<b>Dimensions (HxWxL)</b>	43x38x14 mm
<b>Wire cross section range</b>	0.5 ÷ 1.5 mm <sup>2</sup>

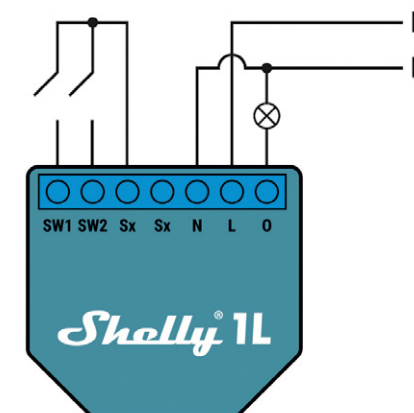

Wiring with neutral

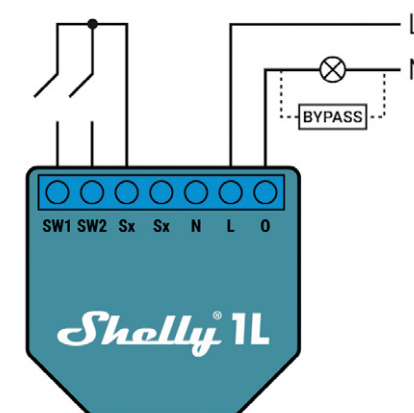

Wiring without neutral

### Legend\*

#### Device terminals:

- SW1:** Switch 1 input terminal
- SW2:** Switch 2 input terminal
- Sx:** Signal for switch terminal
- N:** Neutral terminal
- L:** Live (110-240 VAC) terminals
- O:** Load circuit output terminal

#### Wires:

- L:** Live (110-240 VAC) wire
- N:** Neutral wire

\* When using the device without neutral, Shelly 1L requires at least 20 W of power consumption, in order to operate. If the connected light has a smaller power consumption, then Shelly Bypass is required for the operation of the Device! Shelly Bypass is accessory that will be sold separately!

# Shelly<sup>®</sup> EM



## MEASUREMENTS

- ✓ 2x Power(W)
- ✓ 2x Current(A)
- ✓ 2x Energy(Wh)
- ✓ 2x Load quality
- ✓ 1x Voltage(V)



## ADDITIONAL FEATURES

- ✓ 365 days built-in energy history
- ✓ Relay output for contactor control



### Wi-Fi Connected

Shelly EM can connect directly to any Wi-Fi network, no HUB required or can operate as an Access Point.



### Power Supply

Shelly EM is compatible with all major international voltage standards.



### Dual Power Metering

Shelly EM can monitor in real time the energy consumption simultaneously in 2 circuits on the same phase. (up to 120 A each).



### Contactor Control

2A / 230V 50/60Hz. Shelly EM has integrated relay output made for contactor control.



### Mobile app control

Turn devices on/off directly from your smartphone or tablet. You can manage Shelly EM output from Shelly app, MQTT or Rest API.



### Overconsumption and Over Energy Protection

No more forgotten turned on appliances. The integrated countdown timer can automatically switch off your oven after an hour.



### Embedded Web Server

Turn on/off Shelly devices directly from its interface without the need of any additional controller or hub, thanks to the embedded web.



### Sunrise/Sunset Schedules

Shelly EM can automatically turn on/off based on the sunrise and sunset hours.



### Weekly Schedules

Choose a time and create custom daily schedules for your devices.

# WI-FI-OPERATED ENERGY METER AND CONTACTOR CONTROL

With **Shelly EM** you can measure how much energy your solar system produces.

## TECHNICAL SPECIFICATIONS

<b>Power supply</b>	110-240 VAC, 50/60 Hz
<b>Power metering</b>	Two channels, up to 120 A each
<b>Consumption history</b>	365 days built-in energy history (Wh)
<b>Maximum load</b>	2 A / 240 VAC
<b>Complies with EU standards:</b>	<ul style="list-style-type: none"> <li>• RE Directive 2014/53/EU</li> <li>• LVD 2014/35/EU</li> <li>• EMC 2014/30/EU</li> <li>• RoHS2 2011/65/EU</li> </ul>
<b>Working temperature</b>	0°C ÷ 40°C
<b>Max RF output power:</b>	13 dBm
<b>Wireless/Wi-Fi Protocol</b>	802.11 b/g/n (2.4 GHz)
<b>Frequency</b>	2412 - 2472 MHz
<b>Operational range (depending on local conditions)</b>	<ul style="list-style-type: none"> <li>• up to 50 m outdoors</li> <li>• up to 30 m indoors</li> </ul>
<b>Dimensions (HxWxL)</b>	39x36x17 mm
<b>Electrical consumption:</b>	< 1 W
<b>Additional features</b>	<ul style="list-style-type: none"> <li>• Overpower shutdown</li> <li>• Consumption limit</li> </ul>
<b>Wire cross section range</b>	0.5 ÷ 1.5 mm <sup>2</sup>

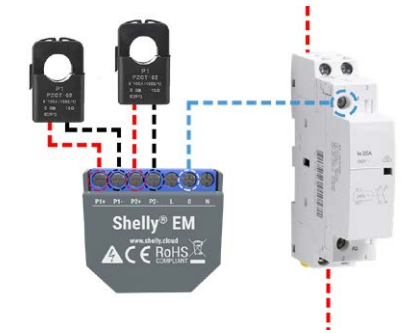

## CONTROL 120A SAFE AND EASY

Shelly EM has integrated relay output made for contactor control

### • Remote control from anywhere

You can manage ShellyEM output from Shelly app, MQTT or Rest API

### • Overpower Control

Automatic shutdown or notification when reaching current consumption limit.

### • Turn off when total consumption is reached

Automatic shutdown when power is reached.

### • Weekly scheduling by time or sun position

Auto turn on and off by hour or sunset and sunrise.



# Shelly® 3EM



- ✓ Precise 3-phase energy metering
- ✓ Up to 120A per phase
- ✓ Integrated 10A contactor control
- ✓ Solar and Wind power compatible
- ✓ Factory calibrated with over 99% accuracy
- ✓ DIN mountable
- ✓ Wi-Fi enabled
- ✓ Cloud and MQTT Enabled
- ✓ 365 days power consumption history



### Wi-Fi connected

Shelly 3EM can be connected to any Wi-Fi network or can operate as an Access Point.



### Power supply

Each phase of Shelly 3EM must be 110-230 VAC, 50/60Hz.



### Monophase systems

Shelly 3EM can also monitor monophase electrical systems with up to 3 points simultaneously.



### Contactor control

Shelly 3EM has an integrated 10A relay output for contactor control.



### Mobile app control

Turn Shelly 3EM on/off directly from your smartphone or tablet. You can manage Shelly 3EM's output from the Shelly Cloud app, MQTT or Rest API.



### Overconsumption and overpower protection

Shelly 3EM can automatically turn off the whole circuit if consumption or energy (pre-paid energy option) reaches the set limit.



### Embedded web server

Turn on/off Shelly 3EM's contactor output directly, without the need of any additional controller or hub.



### Sunrise/sunset schedules

Shelly 3EM can automatically turn on/off the power based on the sunrise/sunset hours.



### Weekly schedules

Choose a time and create custom daily schedules for your Shelly 3EM.

## WI-FI-OPERATED 3 PHASE ENERGY METER AND CONTACTOR CONTROL

Shelly 3EM has integrated relay output which can be used for contactor control.

### TECHNICAL SPECIFICATIONS

<b>Power supply</b>	110-230 VAC, 50/60 Hz
<b>Power metering</b>	3 channels, up to 120 A each
<b>Consumption history</b>	365 days built-in energy history (Wh)
<b>Maximum load</b>	10 A / 240 VAC
<b>Complies with EU standards</b>	<ul style="list-style-type: none"> <li>• RE Directive 2014/53/EU</li> <li>• LVD 2014/35/EU</li> <li>• EMC 2014/30/EU</li> <li>• RoHS2 2011/65/EU</li> </ul>
<b>Working temperature</b>	-20°C ÷ 40°C
<b>Max RF output power</b>	10.28 dBm
<b>Wireless/Wi-Fi Protocol</b>	802.11 b/g/n (2.4 GHz)
<b>Frequency</b>	2412 - 2472 MHz
<b>Operational range (depending on local conditions)</b>	<ul style="list-style-type: none"> <li>• up to 50 m outdoors</li> <li>• up to 30 m indoors</li> </ul>
<b>Dimensions (HxWxD)</b>	73x22x58 mm
<b>Electrical consumption</b>	< 1 W
<b>Additional features</b>	<ul style="list-style-type: none"> <li>• Overpower shutdown</li> <li>• Consumption limit</li> </ul>

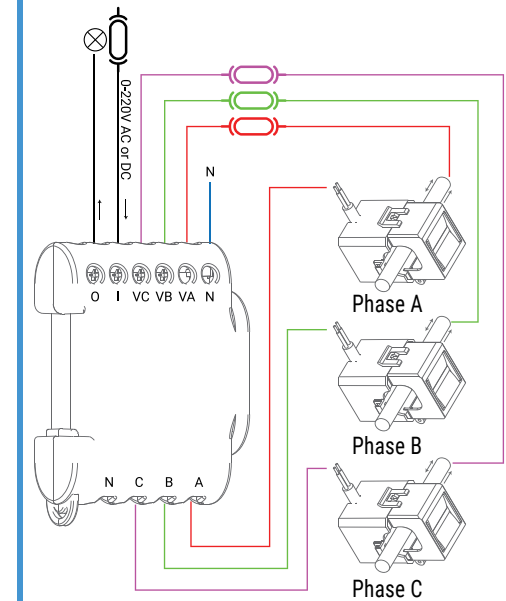



## DEVICE PINOUT

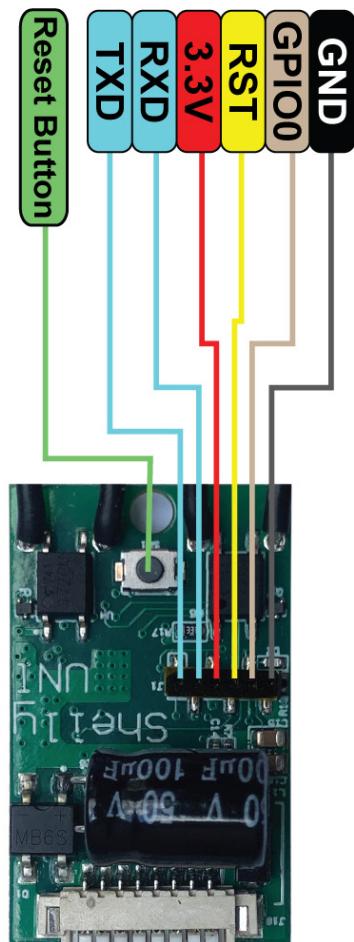

### Wi-Fi Connected

No HUB required – Connect Shelly Bulb directly to your Wi-Fi at home.



### Universally flexible power supply

Shelly UNI can be powered with the wide range of 12V-36V DC and 12V-24V AC.



### Universal ADC

The ADC range can measure any voltage from 0 to 30 VDC. Dual ranges from 0-12V and 12-30V give exceptionally high accuracy.



### Universal temperature & humidity sensors

Shelly UNI supports up to 3xDS18B20 temperature sensors or 1X humidity sensors, making it possible to trigger outputs, local and cloud scenes.



### Universal digital inputs

Includes 2 digital inputs, which can be support differing voltages and work separately from 2.2-36 VDC and 12-24 VAC.



### Potential Free Outputs

2 potential free outputs (dry contacts), up to 36 VDC or 24 VAC, providing the ability to switch a voltages different from the device power supply one.



### Universal protocols

Out of the box, Shelly UNI supports REST, MQTT, CoAP, Alexa, Google Home, and Samsung Smart Things, making it highly compatible with all major home automation platforms.



### Universal resistance

Even though there is no plastic shell, the transparent insulation layer over the chip protects it from high humidity, dust, and the threat of short circuits during its long working hours.

## THE INTELLIGENT WI-FI OPERATED IMPLANT

Make any old appliance smart! Shelly UNI is the smallest universal module with two available digital inputs and potential-free outputs, providing endless functionalities.

## TECHNICAL SPECIFICATIONS

<b>Power supply</b>	12V – 24 VAC, 12 – 36 VDC
<b>Inputs</b>	2 Separated digital inputs from 2.2-36 VDC and 12-24 VAC
<b>Outputs</b>	2 Potential free outputs up to 36 VDC and 24 VAC, max 100 mA each
<b>Power measurement</b>	1 ADC – dual ranges from 0-12V and 0-30V
<b>Channels</b>	2
<b>Working temperature</b>	-20°C ÷ 40°C
<b>Power consumption</b>	< 1W
<b>Complies with EU standards</b>	<ul style="list-style-type: none"> <li>• RE Directive 2014/53/EU</li> <li>• LVD 2014/35/EU</li> <li>• EMC 2014/30/EU</li> <li>• RoHS2 2011/65/EU</li> </ul>
<b>Max RF output power</b>	12.24 dBm
<b>Radio protocol</b>	Wi-Fi 802.11 b/g/n
<b>Frequency</b>	2412 - 2472 MHz
<b>Operational range (depending on local construction)</b>	<ul style="list-style-type: none"> <li>• up to 50 m outdoors</li> <li>• up to 30 m indoors</li> </ul>
<b>Dimensions</b>	20x33x13 mm

- No HUB required.
- Wide range of voltage support.
- 2 digital inputs
- 2 potential-free outputs
- ADC range can measure any voltage from 0 to 30 VDC
- Supports up to 3xDS18B20 temperature sensors or 1X humidity sensors
- Transparent insulation layer over the chip protects it from high humidity, dust, and the threat of short circuits
- It can be integrated with all other Shelly devices.
- Compatible with Android, iOS, Amazon Alexa, Google Assistant, and home automation servers using MQTT, CoAP, and REST API.
- Easily make your Arduino project live and usable in your automation project.



# Shelly<sup>®</sup> PLUG



## SHELLY PLUG SAVES YOU ENERGY AND MONEY



## WITH SHELLY PLUG YOU CAN CONTROL ANY DEVICE AT YOUR HOME FROM ANYWHERE



## WITH SHELLY PLUG YOU MAY OPTIMIZE YOUR TIME



### Wi-Fi Connected

Shelly™ Plug can connect to any Wi-Fi network or can operate as an Access Point.



### Power Consumption

Shelly™ Plug has an integrated precise power meter. You can measure the overall consumption of all the electric devices you are controlling.



### Free Cloud

All you need to manage your Shelly Plug is a smartphone and the Shelly Cloud free mobile application.



### Follow the sunlight

Shelly Plug can automatically turn on/off based on the sunrise and sunset hours.



### Weekly scheduling

Create custom daily schedules for your devices.



### Mobile app control

You can turn on and off your appliances from anywhere in the world.



### Countdown timer

No more forgotten turned on appliances. The integrated countdown timer can automatically switch off your oven after an hour.



### Up To 3500W

With Shelly Plug you can control wide range of devices and appliances.



### Highly compatible

Compatible with Android, iOS, Amazon Alexa and Google Assistant.

## SMART WI-FI-OPERATED PLUG WITH POWER MEASUREMENTS AND 16A MAX LOAD

**Shelly Plug** automatically monitors and controls lightning, heating and any other connected electrical appliance in your house, no matter where you are. When an electric appliance or a lamp is plugged into the Shelly Plug, you can switch it on and off through the Shelly Cloud mobile application. You can do it anytime and from anywhere.

### TECHNICAL SPECIFICATIONS

<b>Power supply</b>	Input 110-230 VAC, 50/60 Hz
<b>Max load</b>	16 A / 230 V
<b>Complies with EU standards</b>	<ul style="list-style-type: none"> <li>• RE Directive 2014/53/EU</li> <li>• LVD 2014/35/EU</li> <li>• EMC 2014/30/EU</li> <li>• RoHS2 2011/65/EU</li> </ul>
<b>Working temperature</b>	-20°C ÷ 40°C
<b>Max RF output power</b>	15 dBm
<b>Wireless/Wi-Fi Protocol</b>	802.11 b/g/n (2.4 GHz)
<b>Frequency</b>	2412 - 2472 MHz
<b>Operational range (depending on local conditions)</b>	<ul style="list-style-type: none"> <li>• up to 50 m outdoors</li> <li>• up to 30 m indoors</li> </ul>
<b>Dimensions (HxWxL)</b>	98x56x35 mm
<b>Processor (CPU)</b>	Texas Instruments CC3200
<b>Remote Control</b>	Trough mobile app & web interface
<b>Compatibility</b>	Android (4.2+) & iOS (8+), web browsers
<b>Languages</b>	Multiple trough mobile app & web interface
<b>Electrical consumption</b>	< 1 W

- Control through Wi-Fi from a mobile phone, PC, automation system or any other device supporting HTTP and/or UDP protocol.
- Microprocessor management.
- Controlling elements: 1 relay.
- Shelly may be controlled by the integrated button.

# Shelly<sup>®</sup> PLUG S



**SHELLY PLUG S CONTROL ANY DEVICE AT YOUR HOME FROM ANYWHERE**



**WITH SHELLY PLUG S YOU CAN CREATE YOUR OWN SCENE THAT WILL SEND YOU A NOTIFICATION DIRECTLY TO YOUR PHONE**



**WITH SHELLY PLUG YOU MAY CAN OPTIMIZE YOUR TIME**



#### Wi-Fi Connected

Just connect Shelly PLUG S to your Wi-Fi network and begin the ultimate experience of controlling your home with your phone.



#### Power Consumption

Shelly Plug will power off any appliance if the predefined power consumption level is reached.



#### Free Cloud

All you need to manage your Shelly PLUG S is a smartphone and the Shelly Cloud free mobile application.



#### Follow the sunlight

Shelly Plug can automatically turn on/off based on the sunrise and sunset hours.



#### Weekly scheduling

Create custom daily schedules for your devices.



#### Mobile app control

You can turn on and off your appliances from anywhere in the world.



#### Countdown timer

No more forgotten turned on appliances. The integrated countdown timer can automatically switch off your oven after an hour.



#### Up To 2300W

With Shelly Plug you can control wide range of devices and appliances.



#### Highly compatible

Compatible with Android, iOS, Amazon Alexa and Google Assistant.

## COMPACT WI-FI SMART PLUG WITH POWER METERING

**Shelly Plug S** fits everywhere and is the most intelligent Wi-Fi plug ever. It automatically controls lightning, heating and any other connected electrical appliance in your house.

### TECHNICAL SPECIFICATIONS

<b>Power supply</b>	230 VAC ±10%, 50/60 Hz
<b>Max load</b>	10 A
<b>Complies with EU standards:</b>	<ul style="list-style-type: none"> <li>• RE Directive 2014/53/EU</li> <li>• LVD 2014/35/EU</li> <li>• EMC 2014/30/EU</li> <li>• RoHS2 2011/65/EU</li> </ul>
<b>Working temperature</b>	-10°C ÷ 40°C
<b>Max RF output power</b>	15 dBm
<b>Wireless/Wi-Fi Protocol</b>	802.11 b/g/n (2.4 GHz)
<b>Frequency</b>	2412 - 2472 MHz
<b>Operational range (depending on local conditions)</b>	<ul style="list-style-type: none"> <li>• up to 50 m outdoors</li> <li>• up to 30 m indoors</li> </ul>
<b>Dimensions (HxWxL)</b>	70x44x44 mm
<b>Processor (CPU)</b>	Texas Instruments CC3200
<b>Remote Control</b>	Through mobile app & web interface
<b>Compatibility</b>	Android (4.2+) & iOS (8+), web browsers
<b>Languages</b>	Multiple through mobile app & web interface

- Control through Wi-Fi from a mobile phone, PC, automation system or any other device supporting HTTP and/or UDP protocol.
- Microprocessor management.
- Controlling elements: 1 relay.
- Shelly may be controlled by the integrated button.



#### Easy installation

1. Plug Shelly in to your existing power socket.
2. Take your smartphone and add the Plug to Shelly Cloud application.
3. Connect your home appliances and enjoy.



# Shelly<sup>®</sup> button1



## 1 BUTTON - 4 ACTIONS

No more stressful bright light during dark hours early in the morning. Set your custom schedule and choose soft and low light while it is still dark outside when.

- 1X - Bedroom light On/Off
- 2X - Blinds are closed
- 3X - Turn fan On/Off
- Long push - Turn Off all lights



### No additional controller

Shelly Button 1 uses your home Wi-Fi network, no additional controllers are needed.



### Built-in Battery

Shelly Button 1 has built-in rechargeable battery allowing more than 3000 actions per charge.



### Color hints

A different color response indication for different situations.



### USB charging

You can charge Shelly Button 1 with Micro-B type USB cable.



### Low-battery alarm

You can set Shelly Button 1 to inform you when the battery levels are low.



### Quick response

Response time of less than 2s on battery and 0,1s on USB power.



### Highly compatible

Shelly Button1 is Cloud connected but can also be connected via MQTT, CoAP, REST API.

## CONTROL EVERYTHING WITH JUST A CLICK

We developed Shelly Button to help you easily activate or deactivate any device or scene manually with just a click. Additionally, Shelly Button is so tiny it can be put and carried around anywhere. The button is battery-powered, and you can put it in your bag, laptop case, or even in your pocket and use it whenever and wherever you need it.

## TECHNICAL SPECIFICATIONS

<b>Power Supply</b>	Two 3 VDC - CR123A Batteries or micro USB 5 V
<b>Battery Lifespan</b>	3000 actions per charge
<b>Complex scenes control</b>	Activate or deactivate synchronized actions of several Shelly devices
<b>Dimming</b>	Yes
<b>Complies with EU standards</b>	<ul style="list-style-type: none"><li>• RE Directive 2014/53/EU</li><li>• LVD 2014/35/EU</li><li>• EMC 2014/30/EU</li><li>• RoHS2 2011/65/EU</li></ul>
<b>Working temperature</b>	0 ÷ 40°C
<b>Max RF output power</b>	10.62 dBm
<b>Radio protocol</b>	Wi-Fi 802.11 b/g/n
<b>Frequency</b>	2412 - 2472 MHz
<b>Operational range (depending on local conditions)</b>	<ul style="list-style-type: none"><li>• up to 50 m outdoors</li><li>• up to 30 m indoors</li></ul>
<b>Dimensions</b>	45x45x16 mm

## SMALL AND MOBILE

Thanks to its small size, Shelly Button 1 can fit in every pocket!



# Shelly Motion2



## COMPATIBLE WITH OTHER DEVICES

Shelly Motion2 can trigger other smart devices in your home network and customize the actions based on hour, light, or various actions.



## LIGHTING CONTROL

Combine Shelly lighting control devices with Shelly Motion2 and set the sensor to turn on the lights the moment you enter the room.



## SMART SCHEDULING

Don't wake up your family during your night-time snack! Set Shelly Motion2 smart scheduling option to turn on the lights very dimly at late hours. That way it will not irritate your eyes or wake your loved ones.



### Wi-Fi operated

Connect Shelly Motion2 to your Wi-Fi network. No HUB required!



### Over 1 year battery life

Count on long-lasting 6500 mAh rechargeable battery.



### Real time response

Response in less than 200 ms and immediate action trigger to another device.



### Light Sensor Included

Shelly Motion2 is enhanced with a light sensor for dynamic adjustment of the brightness levels.



### Temperature Sensor Included

Shelly Motion2 has a temperature sensor.



### Powerful CPU

Equipped with the lowest power consuming Wi-Fi modem in mass production in the world.



### Adjustable sensitivity

256 levels of sensitivity allow adjustment of the distance and the movement to which the sensor reacts.



### Tamper detection

Tamper detection and 128 levels of vibration sensitivity will notify you about the slightest vibration.

## CUSTOM ACTIONS

Create the perfect morning routine! Shelly Motion2 can trigger other smart devices in your home network and customize the actions based on your needs. The moment you wake up, Shelly Motion2 will trigger the automated blinds in your bedroom to open, allowing you to welcome the morning sunshine!

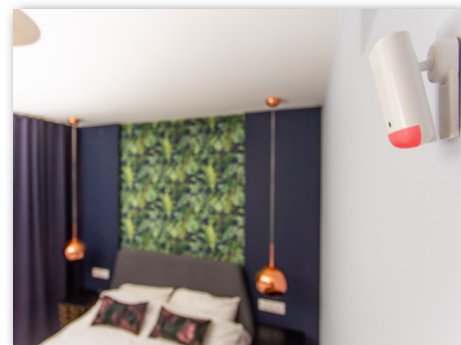

# WI-FI MOTION SENSOR WITH OVER 1 YEAR OF BATTERY LIFE AND LIGHT & TEMPERATURE SENSORS

A new generation Motion Sensor powered by Silicon Labs Wi-Fi IoT solutions, **Shelly Motion2** is equipped with the lowest power-consuming Wi-Fi modem in mass production in the world and enhanced with a light and a temperature sensor for an even more efficient home automation.

## TECHNICAL SPECIFICATIONS

<b>Battery</b>	6500 mAh 3.7V
<b>Battery life</b>	12 - 36 months
<b>Complies with EU standards:</b>	<ul style="list-style-type: none"> <li>• RE Directive 2014/53/EU</li> <li>• LVD 2014/35/EU</li> <li>• EMC 2014/30/EU</li> <li>• RoHS2 2011/65/EU</li> </ul>
<b>Working temperature</b>	0°C ÷ 40°C
<b>Max RF output power</b>	20 dBm
<b>Wireless/Wi-Fi Protocol</b>	802.11 b/g/n (2.4 GHz)
<b>Frequency</b>	2412 - 2472 MHz
<b>Operational range (depending on local conditions)</b>	<ul style="list-style-type: none"> <li>• up to 50 m outdoors</li> <li>• up to 30 m indoors</li> </ul>
<b>Dimensions (HxWxL)</b>	89.3x41.4x21.9 mm 89.3x41.4x47.9 mm
<b>Remote Control</b>	Through mobile app & web interface
<b>Compatibility</b>	Android (4.2+) & iOS (8+), web browsers
<b>Languages</b>	Multiple through mobile app & web interface

## 256 LEVELS OF SENSITIVITY

256 levels of sensitivity will allow you to adjust extremely precisely the distance and the movement to which the sensor reacts.

Easily adjust Shelly Motion2's sensitivity levels through the app wherever you are.



## NO HUB REQUIRED

Shelly Motion2 can be controlled directly and without a hub through your smartphone. This way you can monitor and control your home, set scenes, and adjust settings wherever you are!



## ENERGY EFFICIENT LIGHTS

When you leave for work in the morning, Shelly Motion2 will ensure that all lights switch off once the house is empty and no motion is detected, ensuring that no energy will go to waste!



# Shelly<sup>®</sup> H&T



## WI-FI HUMIDITY & TEMPERATURE SENSOR

Shelly H&T is the world's first Wi-Fi Humidity & Temperature sensor working over 1 year on battery

### MONITOR HUMIDITY IN YOUR HOME



### MONITOR THE TEMPERATURE OF YOUR HEATER OR AIR CONDITIONER.



### MONITOR THE TEMPERATURE IN YOUR FRIDGE OR COOLER



#### Humidity

Monitor excessive changes in humidity. Avoid dryness and conditions for mold growth.



#### Temperature

Be aware of temperature fluctuations and keep your home comfortable at any time.



#### Battery

Battery life up to 18 months. Feel more comfortable with the long-lasting battery life.

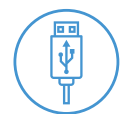

#### USB Add-on

You can power Shelly H&T with a USB instead of a battery using the USB power supply Add-on for Shelly H&T (sold separately, see in Accessories).



#### Easy control

The only thing you need to manage all your Shelly H&T devices is a mobile phone and the free Shelly Cloud application.



#### Wi-Fi

Connect Shelly H&T directly to your Wi-Fi.



#### Free history on Cloud

With Shelly H&T you can see recorded data for humidity and temperature for up to a year.

### TECHNICAL SPECIFICATIONS

<b>Battery</b>	CR123A – 3 V ( <b>NOT</b> included)
<b>Battery life</b>	Up to 18 months
<b>Electrical consumption:</b>	<ul style="list-style-type: none"> <li>• Static ≤70 μA</li> <li>• Awake ≤250 mA</li> </ul>
<b>Humidity measurement range:</b>	0~100% (±5%)
<b>Measurement accuracy</b>	± 1°C
<b>Working temperature</b>	-10°C ÷ 50°C
<b>Max RF output power</b>	9,87 dBm
<b>Wireless/Wi-Fi Protocol</b>	802.11 b/g/n (2.4 GHz)
<b>Frequency</b>	2412 - 2472 MHz
<b>Operational range (depending on local conditions)</b>	<ul style="list-style-type: none"> <li>• up to 50 m outdoors</li> <li>• up to 30 m indoors</li> </ul>
<b>Dimensions (HxWxL)</b>	35x45x45 mm
<b>Complies with EU standards:</b>	<ul style="list-style-type: none"> <li>• RE Directive 2014/53/EU</li> <li>• LVD 2014/35/EU</li> <li>• EMC 2014/30/EU</li> <li>• RoHS2 2011/65/EU</li> </ul>

- With Shelly H&T you can **optimize power consumption** for heating and cooling your home. Do not spend extra money on power consumption if you are not at home.
- **Humidity control** is very important for your health. Keep it at its optimal levels with Shelly H&T.
- Be informed **anytime, anywhere** about everything in your home and control it just with one app without any additional equipment.

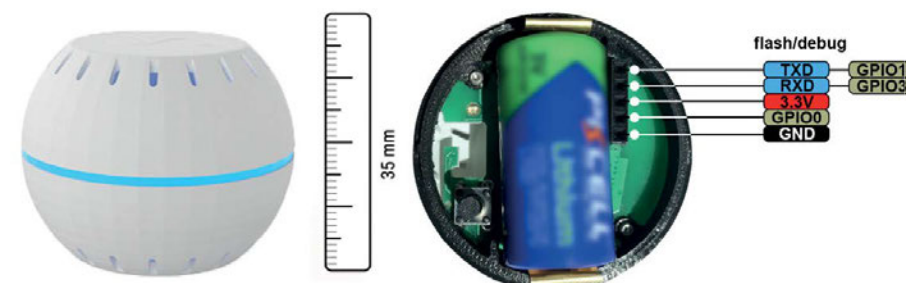

# Shelly TRV



## 2 YEARS BATTERY LIFE

Shelly TRV has 6500 mAh rechargeable battery with up to 2 years of battery life, based on 5 months heating season.



## SMART PROFILES FOR ENHANCED ENERGY EFFICIENCY

Shelly TRV supports 5 profiles with 6 temperature points to each of them. You can set custom settings and control separately each profile to ensure efficient heating usage.

## SMART SCHEDULING

Ensure the efficiency of your heating system by setting Shelly TRV to maintain different levels of heating according to the hour of the day. Customers can set lower levels of heating during working hours of the day.



### Wi-Fi operated

Connect Shelly TRV to your Wi-Fi network. No HUB required



### Long Battery Life

Up to 2 years of battery life, based on 5 months heating season.



### Rechargeable battery

Shelly TRV is equipped with fully rechargeable battery.



### Precise temperature measurement

Stay informed about the temperature of your radiators no matter where you are.



### Wide range of temperature control

Set your room temperature in the range of 5°C to 30°C.



### Quick Profiles

Set profiles and quickly switch between pre-defined settings and schedules.



### Custom schedules and scenes

Set schedules and custom scenes based on your agenda and by combining Shelly TRV with other Shelly devices.

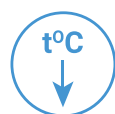

### External temperature sensor support

Connect an external Wi-Fi sensor for precise temperature measurement.



### Control your boiler or pump

Control your boiler/pump automatically to save energy.



### No hub required

Control directly and without a hub through your smartphone with Shelly Cloud App.



### Highly compatible

Use with your preferred home automation platforms and voice assistants.

# INTELLIGENT THERMOSTATIC RADIATOR VALVE FOR HIGHLY EFFICIENT HEATING MANAGEMENT

Shelly TRV replaces the old thermostatic valve in less than 5 minutes. It is enhanced with a rechargeable battery with 2 years of battery life. Shelly TRV supports 5 profiles with 6 temperature points to each of them and can activate custom scenes based on hour, light, or various actions.

## TECHNICAL SPECIFICATIONS

<b>Power supply</b>	Built-in rechargeable battery. USB Type-C charging port (charger not included).
<b>Battery life</b>	Up to 2 years of battery life, based on 5 months heating season
<b>Battery type</b>	3.6 V, 6500 mAh, NCR18650BD Panasonic rechargeable battery
<b>Power consumption</b>	< 500 mA
<b>Complies with EU standards:</b>	<ul style="list-style-type: none"> <li>RE Directive 2014/53/EU</li> <li>LVD 2014/35/EU</li> <li>EMC 2014/30/EU</li> <li>RoHS2 2011/65/EU</li> </ul>
<b>Working temperature</b>	0°C ÷ 30°C
<b>Temperature control range</b>	5°C ÷ 30°C
<b>Max RF output power</b>	15 dBm
<b>Wireless/Wi-Fi Protocol</b>	802.11 b/g/n (2.4 GHz)
<b>Frequency:</b>	2412 - 2472 MHz
<b>Operational range (depending on local conditions)</b>	<ul style="list-style-type: none"> <li>up to 50 m outdoors</li> <li>up to 30 m indoors</li> </ul>
<b>Dimensions (HxWxL)</b>	62x53x94 mm

## INSTALLATION IN 4 EASY STEPS

1) Remove your existing thermostatic valve of your radiator.



2) If needed, use one of adaptors included in the package.

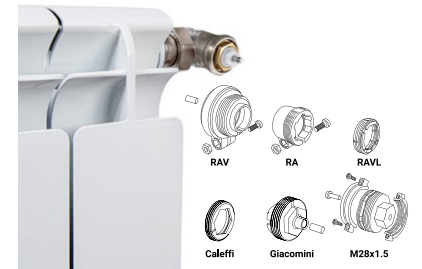

3) Mount Shelly TRV on the radiator.



4) Connect Shelly TRV to your home Wi-Fi network and operate it through Shelly Cloud application.





# Shelly<sup>®</sup> flood



## INSTANT NOTIFICATIONS



## DETECTS LEAKAGE

Place Shelly Flood anywhere you think there is a chance for leaks and get instant notification if water is detected.



## USE YOUR FLOOR HEATING, ONLY WHEN YOU NEED IT

Shelly Flood informs you about the temperature fluctuations and help you set the right temperature for your floor heating.



### Flood detection alarm

You will receive a notification if any fluid is detected by Shelly Flood.



### Temperature

Be aware of temperature fluctuations and keep your floor heating at the desired temperature.



### Battery

Feel comfortable with the up to 18 month battery life.



### Easy control

The only thing you need to manage your Shelly Flood, is a mobile phone and the free Shelly Cloud application.



### Wi-Fi

Connect Shelly Flood directly to your Wi-Fi.



### Free history on Cloud

With Shelly Flood you can see recorded data for temperature up to a year.



## FLOOD SENSOR WITH TEMPERATURE MEASUREMENT

With **Shelly Flood**, you can monitor the temperature of your home and receive instant notification if any liquid leakage is detected in your home

## TECHNICAL SPECIFICATIONS

<b>Battery</b>	CR123A – 3V ( <b>NOT</b> included)
<b>Battery life</b>	Up to 18 months
<b>Electrical consumption</b>	<ul style="list-style-type: none"> <li>• Static ≤5 μA</li> <li>• Awake ≤100 mA</li> <li>• Alarm ≤120 mA</li> </ul>
<b>Measurement accuracy</b>	± 1°C
<b>Working temperature</b>	-40°C ÷ 60°C
<b>Max RF output power</b>	10 dBm
<b>Wireless/Wi-Fi Protocol</b>	802.11 b/g/n (2.4 GHz)
<b>Frequency</b>	2412 - 2472 MHz
<b>Operational range (depending on local conditions)</b>	<ul style="list-style-type: none"> <li>• up to 30 m outdoors</li> <li>• up to 10 m indoors</li> </ul>
<b>Dimensions (HxWxL)</b>	70x70x19 mm
<b>Complies with EU standards</b>	<ul style="list-style-type: none"> <li>• RE Directive 2014/53/EU</li> <li>• LVD 2014/35/EU</li> <li>• EMC 2014/30/EU</li> <li>• RoHS2 2011/65/EU</li> </ul>

## EASY INSTALATION

### 3 easy steps

1. Download the Shelly Cloud application on your smartphone or tablet
2. Connect Shelly Flood sensor to your Wi-Fi router
3. Place the device where there is even the slightest chance of leakage.



# Shelly® Door/Window2



## LIGHTING FAST RESPONSE

For at least 1.5 seconds the sensor will send local request to another Shelly device or over MQTT. Response time depends on the local Wi-Fi network. Signal strength, fixed IP address and fast router maintain fast association.



## BATTERY LIFE

More than 12 000 wake-up and 18 months of battery life. The very low power CPU combined with 2x CR123A battery allow more than 2-year battery life thus making the Shelly Door/Window the device with longest battery life.



### No additional controller

Shelly Door/Window sensor uses your home Wi-Fi network, no additional controllers are needed.



### Open-close sensor

Shelly Door/Window detects and reports the opening and closing of doors and windows.



### Temperature sensor

Be aware of temperature fluctuations and keep your home comfortable at any time.



### Wire free

Simply place it at your door or window.



### Free Cloud

All you need to manage your Shelly Door/Window sensor is a smartphone and the Shelly Cloud free mobile application.



### Battery life up to 2 years

Feel more comfortable with the long-lasting battery life.

## A DOOR AND WINDOW SENSOR WITH LUX MEASUREMENT AND FAST RESPONSE

Shelly Door/Window 2 is designed to detect and report the opening and closing of doors and windows. Its compact and improved design allows it to be easily installed on any door or window, and because of its lightweight, the sensor is nearly invisible.

### TECHNICAL SPECIFICATIONS

<b>Power Supply</b>	Two 3 VDC - CR123A non-rechargeable
<b>Battery Lifespan</b>	up to 18 months
<b>Complies with EU standards</b>	<ul style="list-style-type: none"> <li>• RE Directive 2014/53/EU</li> <li>• LVD 2014/35/EU</li> <li>• EMC 2014/30/EU</li> <li>• RoHS2 2011/65/EU</li> </ul>
<b>Working temperature</b>	-10 ÷ 50°C
<b>Max RF output power</b>	12.71 dBm
<b>Radio protocol</b>	Wi-Fi 802.11 b/g/n
<b>Frequency</b>	2412 - 2472 MHz
<b>Operational range (depending on local conditions)</b>	<ul style="list-style-type: none"> <li>• up to 50 m outdoors</li> <li>• up to 30 m indoors</li> </ul>
<b>Dimensions</b>	Sensor 82x23x20mm Magnet 52x16x13mm
<b>Electrical consumption</b>	Static current: ≤10 µA Alarm current: ≤60 mA

### Easy set up:

1. Attach Shelly Door/Window2 sensor to any door or window frame. The two parts of the sensor need to be close to one another.
2. Download the Shelly Cloud application on your smartphone or tablet.
3. Connect Shelly Door/Window2 to your Wi-Fi router
4. Add Shelly Door/Window2 to Shelly Cloud.



Door/window is opened



230LUX is detected



Light ON

via REST HTTP/MQTT/CoAP/Cloud



# Shelly<sup>®</sup> GAS



## LPG AND CNG VERSION

Shelly Gas comes in two versions - with LPG (Liquefied Petroleum Gas) or CNG (Compressed Natural Gas) detection. Shelly GAS supports interchangeable plug extensions in order to be compatible with different power socket standards.



## INTERCHANGEABLE PLUG

Shelly GAS supports interchangeable plug extensions in order to be compatible with different power socket standards.



## PROTECT YOUR HOME

Thanks to its high sensitivity, Shelly Gas will immediately detect gas leakage and release light and sound alarms, as well as will send notification to your phone in case you are away of home.



### No additional controller

Shelly GAS sensor uses your home Wi-Fi network, no additional controllers are needed.



### Gas sensor

A smart gas sensor that can detect LPG or CNG and monitor your household's safety.



### Flame resistant

With a flame resistant shell, Shelly GAS will be always there for you.



### Wire free

Simply plug it to your power socket.



### Free Cloud

All you need to manage your Shelly GAS sensor is a smartphone and the Shelly Cloud free mobile application.



### GAS concentration

Low: 1800 ppm; High: 3000 ppm

## SMART WI-FI GAS DETECTOR FOR LPG OR CNG

Many home appliances are dependent on natural gas, but not many homes have sensory detection for gas leaks, which can be dangerous. Shelly GAS can detect Natural Gas or Liquefied petroleum gas helping you provide additional protection for your home and family. Its long life span, little sensitivity drift, and Wi-Fi technology allow you always to know if gas is threatening your home.

## TECHNICAL SPECIFICATIONS

<b>Power Supply</b>	110-230 VAC ±10%, 50/60Hz
<b>Alarm indicator</b>	LED Flash & Sound
<b>Alarm sensitivity</b>	6% LEL
<b>Valve manipulator jack output</b>	11-13 V, 500 mA
<b>Sound level</b>	≥70 dB
<b>Gas detector</b>	LPG or CNG
<b>Complies with EU standards</b>	<ul style="list-style-type: none"> <li>• RE Directive 2014/53/EU</li> <li>• LVD 2014/35/EU</li> <li>• EMC 2014/30/EU</li> <li>• RoHS2 2011/65/EU</li> </ul>
<b>Working temperature</b>	-10 ÷ 50°C
<b>Max RF output power</b>	16.28 dBm
<b>Radio protocol</b>	Wi-Fi 802.11 b/g/n
<b>Frequency</b>	2412 - 2472 MHz
<b>Operational range (depending on local conditions)</b>	<ul style="list-style-type: none"> <li>• up to 50 m outdoors</li> <li>• up to 30 m indoors</li> </ul>
<b>Dimensions</b>	89,5x89,5x38 mm (plug not included)
<b>Electrical consumption</b>	< 3 W

## SMART SCENES

Shelly GAS can be placed almost anywhere - in the kitchen, in your bathroom, etc. Just put the device anywhere you think there is even a slight chance for gas leakage, and create your scenes for when gas is detected - windows can be opened, doors unlocked, or lights turned on.



# Shelly<sup>®</sup> DUO



## COLOR TEMPERATURE GUIDE

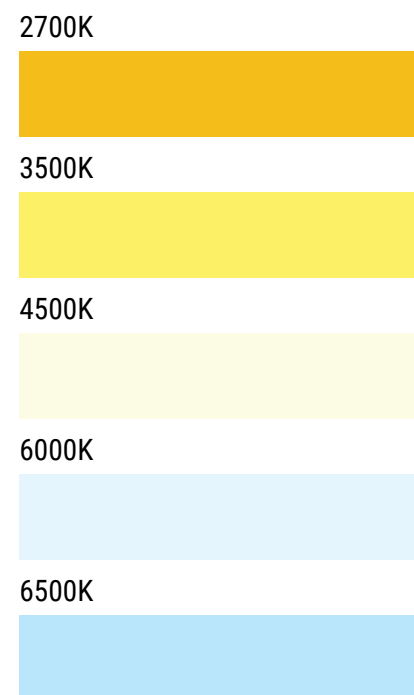

**Wi-Fi Connected**  
No HUB required – Connect Shelly Bulb directly to your Wi-Fi at home and dim it.



**Energy Efficient**  
Reduce energy usage without brightness or quality loss.



**Easy Control**  
The only thing you need to manage all your Shelly Bulbs is a mobile phone and the free Shelly Cloud application.



**Dimmable light**  
Enjoy dimmable light by fine-tuning your brightness.



**Set Schedules**  
Shelly Bulb can wake you up and help you energize, read, concentrate and relax.



**Highly Compatible**  
Compatible with Android, iOS, Amazon Alexa and Google Assistant.



**Follow the Sunlight**  
Shelly Bulb can automatically turn on/off based on the sunrise and sunset hours.

## SMART DIMMABLE BULB

**Shelly Duo** - Wi-Fi on board, Cloud and MQTT enabled, dimmable, voice control, smart Wake-up and Night mode. Automatically follow the sun and control your light accordingly. You can set your Shelly Duo bulbs directly from your phone and have them turn on/off based on the sunrise and sunset hours. Set Wake-up or Night mode with soft, dimmed light and the right color temperature.

## TECHNICAL SPECIFICATIONS

	Shelly DUO	Shelly DUO GU10
<b>Power supply</b>	210-230 VAC, 50/60 Hz	
<b>Socket</b>	E27	GU10
<b>Power Rating</b>	9 W	5 W
<b>Brightness</b>	Warm White: 475 lm	
<b>Color Temperature</b>	2700K - 6500 K	
<b>Working temperature</b>	-10°C ÷ 40°C	
<b>Beam Angle</b>	270°	36°
<b>Complies with EU standards</b>	<ul style="list-style-type: none"> <li>• RE Directive 2014/53/EU</li> <li>• LVD 2014/35/EU</li> <li>• EMC 2014/30/EU</li> <li>• RoHS2 2011/65/EU</li> </ul>	
<b>Max RF output power</b>	15 dBm	
<b>Radio protocol</b>	Wi-Fi 802.11 b/g/n	
<b>Frequency</b>	2412 - 2472 MHz	
<b>Operational range (depending on local construction)</b>	<ul style="list-style-type: none"> <li>• up to 15 m outdoors</li> <li>• up to 8 m indoors</li> </ul>	
<b>Dimensions</b>	60x122 mm	50x73 mm
<b>Electrical consumption</b>	< 1 W	
<b>SAR</b>	1.10 W/Kg	





# Shelly DUO RGBW



## 16 MILLION COLORS



## WARM AND COLD LIGHT



### Wi-Fi operated

Connect Shelly Bulb to your Wi-Fi at home.



### Energy efficient

Reduce energy usage without brightness or quality loss.



### 16 million colors

Set the mood by choosing between 16 million colors.



### Light temperature control

Easily set the desired light temperature.



### Control remotely

Turn Shelly Bulb RGBW ON/OFF directly from your smartphone or tablet, and manage them easily no matter where you are.



### Weekly Schedules

Easily create custom daily schedules and smart timers.



### Sunrise/Sunset

Set Shelly Bulb RGBW to automatically turn ON/OFF based on sunrise and sunset hours.



### No hub required

Control directly and without a hub through your smartphone with Shelly Cloud App.



### Highly compatible

Use with your preferred home automation platforms and voice assistants.

## SMART RGBW BULB WITH 16 MILLION COLORS

Shelly Bulb RGBW allows customers to control and adjust the brightness and the color of their light, choosing between 16 million colors. Shelly Bulb RGBW connects directly to the Wi-Fi at home and allows setting custom schedules, smart scenarios and Sunrise/Sunset actions.

### TECHNICAL SPECIFICATIONS

	Shelly DUO	Shelly DUO GU10
<b>Power supply</b>	110-230 VAC ±10%, 50/60 Hz	
<b>Socket</b>	E27	GU10
<b>Power Rating</b>	9 W	5 W
<b>Brightness</b>	Warm White: 475 lm	Warm White: 475 lm
<b>Color Temperature</b>	3000K - 6500 K	3000K - 6500 K
<b>Working temperature</b>	-10°C ÷ 40°C	-10°C ÷ 40°C
<b>Beam Angle</b>	270°	36°
<b>Complies with EU standards</b>	<ul style="list-style-type: none"> <li>• RE Directive 2014/53/EU</li> <li>• LVD 2014/35/EU</li> <li>• EMC 2014/30/EU</li> <li>• RoHS2 2011/65/EU</li> </ul>	
<b>Max RF output power</b>	15 dBm	
<b>Radio protocol</b>	Wi-Fi 802.11 b/g/n	
<b>Frequency</b>	2412 - 2472 MHz	
<b>Operational range (depending on local construction)</b>	<ul style="list-style-type: none"> <li>• up to 15 m outdoors</li> <li>• up to 8 m indoors</li> </ul>	
<b>Dimensions</b>	60x122 mm	50x73 mm
<b>Electrical consumption</b>	< 1 W	
<b>SAR</b>	1.10 W/Kg	



# Shelly® Vintage



A60 MODEL



ST64 MODEL



G125 MODEL



#### Wi-Fi Connected

No HUB required – Connect Shelly Bulb directly to your Wi-Fi at home and choice of 16 million colors.



#### Energy Efficient

Reduce energy usage without brightness or quality loss.



#### Easy Control

The only thing you need to manage all your Shelly Bulbs is a mobile phone and the free Shelly Cloud application.



#### Dimmable light

Enjoy dimmable light by fine-tuning your brightness.



#### Set Schedules

Shelly Bulb can wake you up and help you energize, read, concentrate and relax.



#### Highly Compatible

Compatible with Android, iOS, Amazon Alexa and Google Assistant.



#### Follow the Sunlight

Shelly Bulb can automatically turn on/off based on the sunrise and sunset hours.

## SMART DIMMABLE VINTAGE BULB

**Shelly Vintage** - Wi-Fi on board, Cloud and MQTT enabled, dimmable, voice control, smart Wake-up and Night mode. The smart vintage bulbs with spectacular design! Automatically follow the sun and set your light accordingly. You can control your Shelly Vintage bulbs directly from your phone and have them turn on/off based on the sunrise and sunset hours. Set Wake-up or Night mode with soft, dimmed light.

### TECHNICAL SPECIFICATIONS

Type	A60	ST64	G126
Power supply	7 W		4 W
Socket	E27		
Power Rating	PF > 0.5		
Brightness	750 lm	260 lm	
Color Temperature	2700 K		
Working temperature	-10°C ÷ +40°C		
Beam Angle	360°		
Complies with EU standards	<ul style="list-style-type: none"> <li>• RE Directive 2014/53/EU</li> <li>• LVD 2014/35/EU</li> <li>• EMC 2014/30/EU</li> <li>• RoHS2 2011/65/EU</li> </ul>		
Max RF output power	15 dBm		
Radio protocol	Wi-Fi 802.11 b/g/n		
Frequency	2412 - 2472 MHz		
Operational range (depending on local construction)	up to 15m outdoors up to 8m indoors		
Dimensions	60x115mm	64x160mm	125x155mm
Electrical consumption	< 1 W		
SAR	1.10 W/Kg		

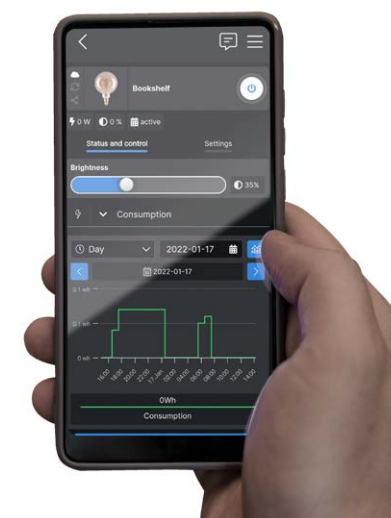

#### QUICK AND EASY SET UP:

1. Screw in your Shelly Vintage Bulb in the light socket.
2. Download the Shelly Cloud application on your smartphone or tablet.
3. Connect Shelly Vintage bulb to your Wi-Fi router
4. Add Shelly Vintage bulb to Shelly Cloud and browse through the many possible settings.

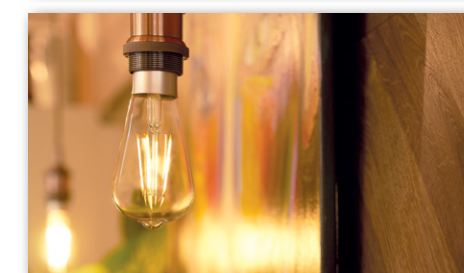



# SUPREME HOME AND FACILITY AUTOMATION WITH SHELLY'S PROFESSIONAL LINE OF DIN-RAIL SMART SWITCHES



Enhanced with temperature, overpower, and overvoltage load protection, Shelly Pro series is designed to be installed inside the breaker box (DIN). Allowing full smart automation with no additional cables or wiring, Shelly Pro line is perfect for homes, offices, stores, business, and manufacturing facilities, as well as new buildings.

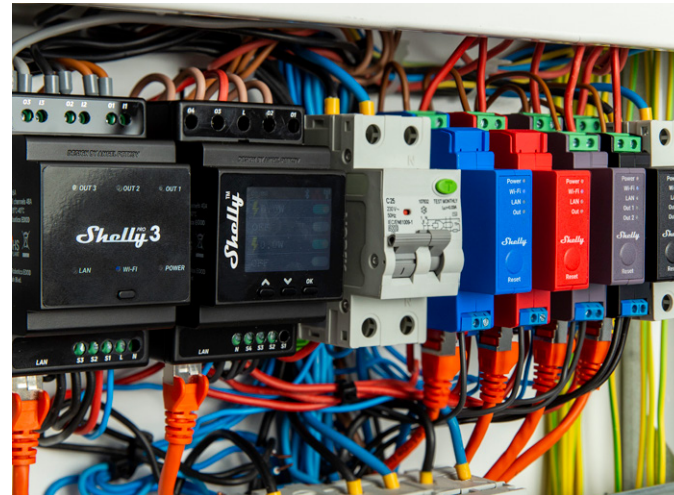

## AUTOMATION STRAIGHT FROM THE BREAKER BOX

Shelly Pro line allows full automation from the breaker box with minimized additional cables or wiring required. That makes it the perfect solution for new buildings and manufacturing facilities, which you can automate based on your or your business's needs.

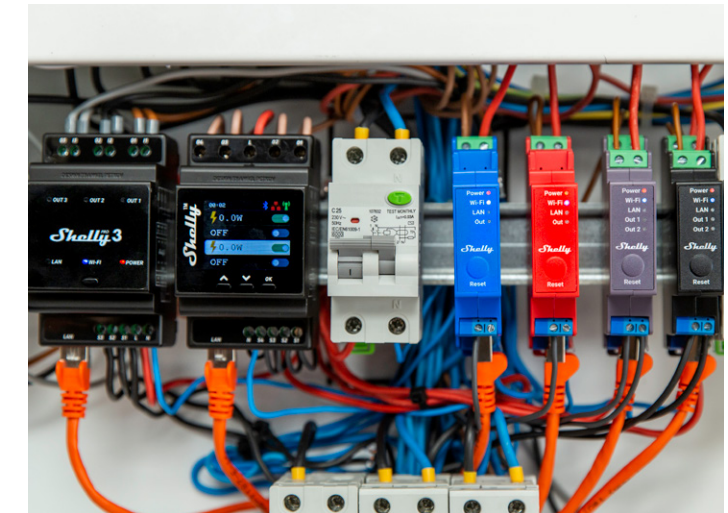

## CAPABILITIES



### CONNECTIVITY



Wi-Fi



Bluetooth



LAN



## PRECISE POWER MEASUREMENT

The PM devices of Shelly Pro line are equipped with ESP32 processor, providing immediate notifications and real-time power consumption measurements.

### ENHANCED SAFETY



Temperature protection



Overpower protection (PM devices)



Flame Retardant (V+0)



Overvoltage protection (PM devices)

### FEATURES



HTTP/HTTPS webhooks



Sunrise/Sunset actions with offsets



Weekly Scheduling



Custom scripts(mJs)



Grouping



Scenes

## ENHANCED WITH

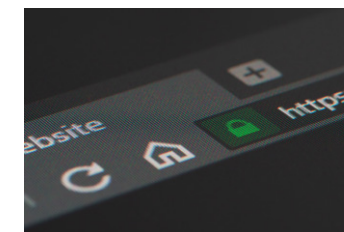

**HTTP/HTTPS webhooks**  
Get notifications or control another compatible equipment or 3rd party automation system.

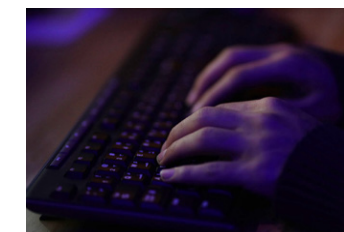

**Scripting for custom automation**  
Get enhanced functionalities and additional processes settings for a specific integration or function.

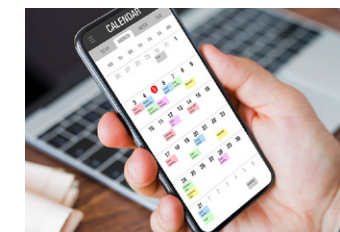

**Weekly scheduling automation**  
Quickly set actions based on your daily or weekly schedule.

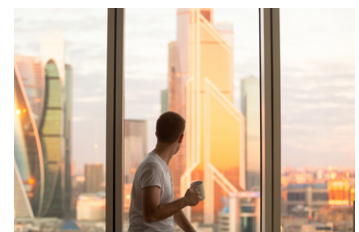

**Smart actions for dynamic control**  
Set Shelly Pro devices to switch on/off the power, based on the Sunset/Sunrise hour and enjoy dynamic control.

All images for illustrative purposes only.

# Shelly PRO 1



## USE SHELLY PRO 1 for

Shelly Pro 1 is enhanced with scripting functionalities, allowing users to set custom automation scenes based on various occurrences such as weather forecast, wind force forecast, etc.



Lights control

Bathroom fan control



Irrigation system

Pool pump control



### LAN, Wi-Fi and Bluetooth

Simultaneous Wi-Fi and LAN usage, add device fast and easy via Bluetooth connection



### 1 channel relay

1 output, 16 A



### Dry Contacts

Supports a wide range of voltages, with dry contacts



### Wide range of voltage support

Shelly Pro 1 can be powered by 110-240 VAC

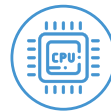

### Extremely fast processor

For immediate command execution and notification.



### Wide variety of appliances control

Suitable for automating the lights, appliances, irrigation system, pool system, heaters, and many more.



### Enhanced safety

Flame retardant shell (V-0) with internal overtemperature protection.



### Enhanced security

MQTT and WSS support, TLS and custom certificates support for a broad range of use cases.



### No hub required

Control directly and without a hub through your smartphone with Shelly Cloud App.



### Highly compatible

Use with your preferred home automation platforms and voice assistants.

## PROFESSIONAL LIGHTS AND APPLIANCES AUTOMATION FOR RESIDENTIAL OR COMMERCIAL USE

**Shelly Pro 1** is a one-phase, 1 channel relay supporting up to 16 A. Equipped with potential-free outputs (dry contacts), Shelly Pro 1 offers high flexibility in voltage support and applications. Power it with 110-240 VAC, use scripting functionalities to set custom automation scenes based on various occurrences.

## TECHNICAL SPECIFICATIONS

<b>Power supply</b>	110-240 VAC, 50/60 Hz;
<b>Max load</b>	16 A
<b>Complies with EU standards:</b>	<ul style="list-style-type: none"> <li>• RE Directive 2014/53/EU</li> <li>• LVD 2014/35/EU</li> <li>• EMC 2014/30/EU</li> <li>• RoHS2 2011/65/EU</li> </ul>
<b>Working temperature</b>	-20°C to 40°C
<b>Max RF output power</b>	13.35 dBm
<b>Wireless/Wi-Fi Protocol</b>	802.11 b/g/n (2.4 GHz)
<b>Frequency:</b>	2412 - 2472 MHz
<b>Operational range (depending on local conditions)</b>	<ul style="list-style-type: none"> <li>• up to 50 m outdoors</li> <li>• up to 30 m indoors</li> </ul>
<b>Dimensions (HxWxD)</b>	94x19x69 mm
<b>Electrical consumption</b>	< 3 W
<b>Wire cross section range</b>	0.5 - 1.5 mm <sup>2</sup> (blue) 0.5 - 2.5 mm <sup>2</sup> (green)

## HOW TO CONNECT

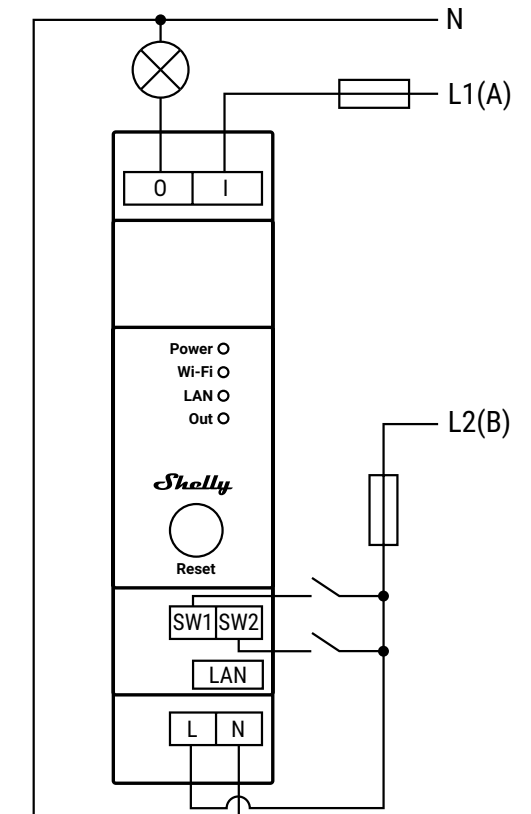

### Legend

#### Device terminals:

- O:** Load output terminal
- I:** Load input terminal
- SW1, SW2:** Switch input terminals controlling O\*
- L:** Live (110-240 VAC) terminal
- N:** Neutral terminal
- LAN:** Local Area Network RJ 45 connector

#### Cables:

- N:** Neutral cable
  - L:** Live (110-240 VAC) cable
  - L1(A):** Load circuit live (110-240 VAC) cable
  - L2(B):** Device power supply live (110-240 VAC) cable
- \* Can be reconfigured in the Device settings



# Shelly PRO 1PM



## USE SHELLY PRO 1PM for

Shelly Pro 1PM allows customers to automate, measure the power consumption, and analyze data from lights and appliances. Different types of actions, scenarios and schedules can be set to sync your environment to your daily activities or business needs.

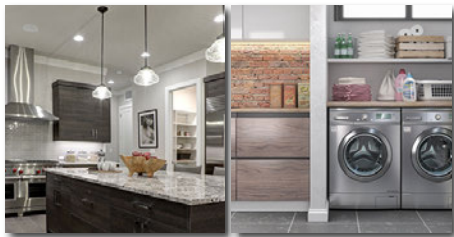

Lights control Laundry machine monitoring



Water heater automation Floor heating automation



**LAN, Wi-Fi and Bluetooth**  
Simultaneous Wi-Fi and LAN usage, add device fast and easy via Bluetooth connection.



**1 channel relay**  
1 output, 16 A.



**Wide range of voltage support**  
Shelly Pro 1PM can be powered by 110-240 VAC



**Power metering with data storage**  
Integrated precise power meter that allow you to measure the consumption of the lights or appliances.



**Wide variety of appliances control**  
Suitable for automating & measuring the consumption of lights, dishwashers, washing machines, appliances, etc.



**Enhanced safety**  
Flame retardant shell (V-0) with internal overtemperature, over-power and overvoltage protection.



**Enhanced security**  
MQTT and WSS support, TLS and custom certificates support for a broad range of use cases.



**No hub required**  
Control directly and without a hub through your smartphone with Shelly Cloud App.



**Highly compatible**  
Use with your preferred home automation platforms and voice assistants.

## ENHANCED ELECTRICAL APPLIANCES AUTOMATION WITH PRECISE POWER METERING

Shelly Pro 1PM is a one-phase, 1 channel relay supporting up to 16A. Equipped with integrated power meter, it allows users to measure the precise power consumption of all automated lights or appliances. Shelly Pro 1PM is suitable for automating & measuring the consumption of lights, dishwashers, washing machines, appliances, etc. Power it with 110-240VAC, use scripting functionalities to set custom automation scenes based on various occurrences.

### TECHNICAL SPECIFICATIONS

<b>Power supply</b>	110-240 VAC, 50/60 Hz
<b>Max load</b>	16 A
<b>Complies with EU standards:</b>	<ul style="list-style-type: none"> <li>• RE Directive 2014/53/EU</li> <li>• LVD 2014/35/EU</li> <li>• EMC 2014/30/EU</li> <li>• RoHS2 2011/65/EU</li> </ul>
<b>Working temperature</b>	-20°C to 40°C
<b>Max RF output power</b>	13.34 dBm
<b>Wireless/Wi-Fi Protocol</b>	802.11 b/g/n (2.4 GHz)
<b>Frequency:</b>	2412 - 2472 MHz
<b>Operational range (depending on local conditions)</b>	<ul style="list-style-type: none"> <li>• up to 50 m outdoors</li> <li>• up to 30 m indoors</li> </ul>
<b>Dimensions (HxWxD)</b>	94x19x69 mm
<b>Electrical consumption</b>	< 3 W
<b>Wire cross section range</b>	0.5 - 1.5 mm <sup>2</sup> (blue) 0.5 - 2.5 mm <sup>2</sup> (green)

### HOW TO CONNECT

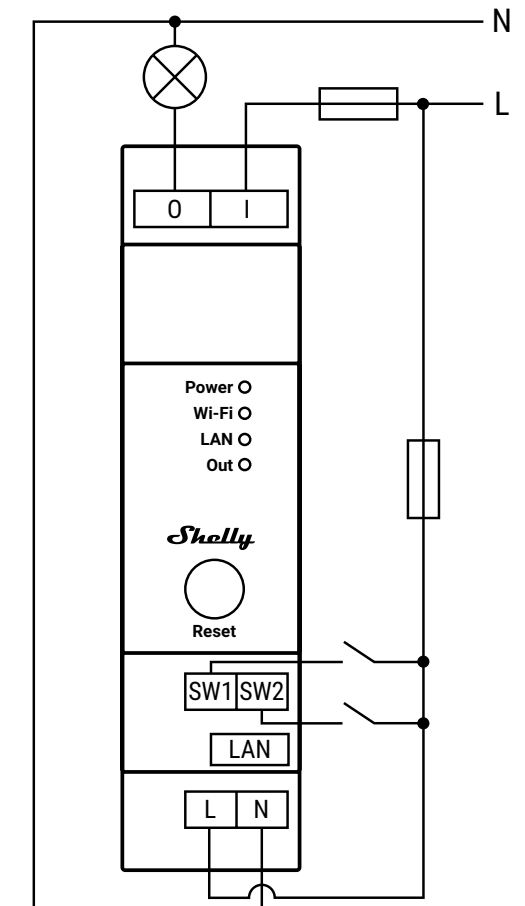

#### Legend

- Device terminals:**  
**O:** Load output terminals  
**I:** Load input terminals  
**SW1, SW2:** Switch input terminals controlling O\*  
**L:** Live (110-240 VAC) terminal  
**N:** Neutral terminal  
**LAN:** Local Area Network RJ 45 connector  
**Cables:**  
**N:** Neutral cable  
**L:** Live (110 - 240 VAC) cable  
*\* Can be reconfigured in the Device settings*

# Shelly <sup>PRO</sup> 2



## USE SHELLY PRO 2 FOR

Shelly Pro 2 is enhanced with scripting functionalities, allowing users to set custom automation scenes based on various occurrences such as weather forecast, wind force forecast, etc.



### LAN, Wi-Fi and Bluetooth

Simultaneous Wi-Fi and LAN usage, add device fast and easy via Bluetooth connection



### 2 channels relay

2 outputs, 16 A each. Total device maximum capacity 25 A.



### Dry Contacts

Supports a wide range of voltages, with dry contacts.



### Wide range of voltage support

Shelly Pro 2 can be powered by 110-240 VAC



### Extremely fast processor

For immediate command execution and notification.



### Wide variety of appliances control

Suitable for automating the lights on 2 phases, appliances, pool and heating system, and many more.



### Enhanced safety

Flame retardant shell (V-0) with internal overtemperature protection.



### Enhanced security

MQTT and WSS support, TLS and custom certificates support for a broad range of use cases.



### No hub required

Control directly and without a hub through your smartphone with Shelly Cloud App.



### Highly compatible

Use with your preferred home automation platforms and voice assistants.

## APPLIANCES AUTOMATION AND LIGHTS CONTROL ON 2 PHASES!

Shelly Pro 2 is two-phases and 2 channels relay, supporting up to 25 A. Equipped with potential-free outputs (dry contacts), Shelly Pro 2 offers high flexibility in voltage support and applications. Power it with 110-240 VAC, use scripting functionalities to set custom automation scenes based on various occurrences.

## TECHNICAL SPECIFICATIONS

<b>Power supply</b>	110-240 VAC, 50/60 Hz
<b>Max load per channel</b>	16 A
<b>Total max. current of all outputs</b>	25 A
<b>Complies with EU standards:</b>	<ul style="list-style-type: none"> <li>• RE Directive 2014/53/EU</li> <li>• LVD 2014/35/EU</li> <li>• EMC 2014/30/EU</li> <li>• RoHS2 2011/65/EU</li> </ul>
<b>Working temperature</b>	-20°C to 40°C
<b>Max RF output power</b>	13.35 dBm
<b>Wireless/Wi-Fi Protocol</b>	802.11 b/g/n (2.4 GHz)
<b>Frequency:</b>	2412 - 2472 MHz
<b>Operational range (depending on local conditions)</b>	<ul style="list-style-type: none"> <li>• up to 50 m outdoors</li> <li>• up to 30 m indoors</li> </ul>
<b>Dimensions (HxWxD)</b>	94x19x69 mm
<b>Electrical consumption</b>	< 3 W
<b>Wire cross section range</b>	0.5 - 1.5 mm <sup>2</sup> (blue) 0.5 - 2.5 mm <sup>2</sup> (green)

## HOW TO CONNECT

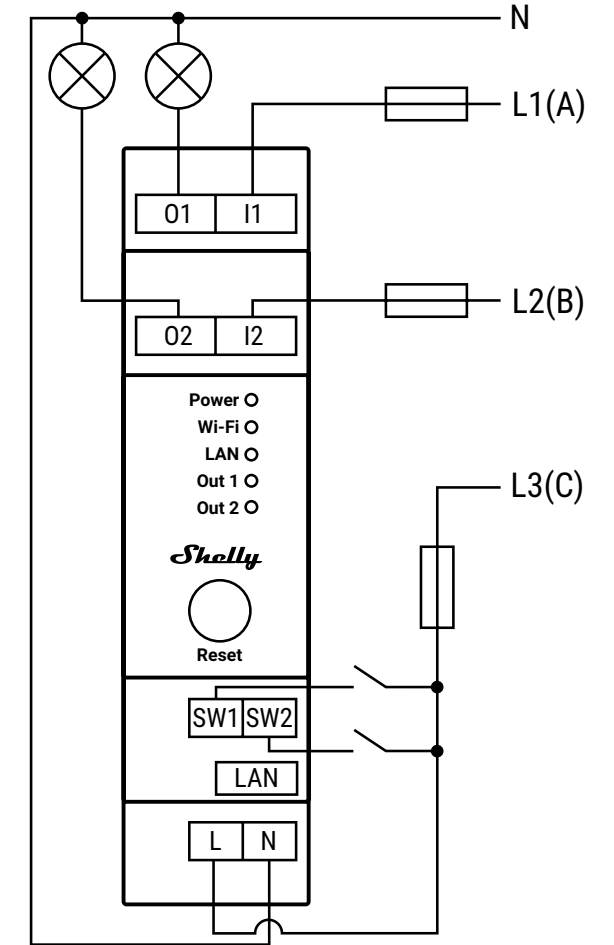

### Legend

#### Device terminals:

- O1, O2: Load output terminals
- I1, I2: Load input terminals
- SW1, SW2: Switch input terminals controlling O1 and O2
- L: Live (110-240 VAC) terminal
- N: Neutral terminal
- LAN: Local Area Network RJ 45 connector

#### Cables:

- N: Neutral cable
- L1(A): Load circuit 1 live (110-240 VAC) cable
- L2(B): Load circuit 2 live (110-240 VAC) cable
- L3(C): Device power supply live (110-240 VAC) cable



# Shelly PRO 2PM



## USE SHELLY PRO 2PM FOR

Shelly Pro 2PM supports two-directional motor control, which makes it perfect for automation of roller shutters, curtains, awnings, and gates. Customers can use scripting functionalities to set custom automation scenes based on various occurrences, weather forecast, wind forecast, etc.



Roller shutter automation

Curtains automation

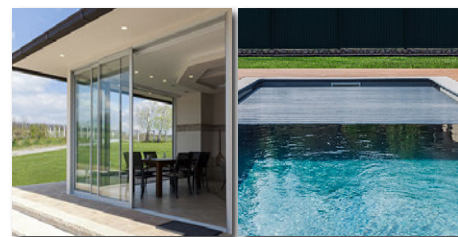

Sliding doors control

Pool cover automation



Office blinds

Gate automation



### LAN, Wi-Fi and Bluetooth

Simultaneous Wi-Fi and LAN usage, add device fast and easy via Bluetooth connection



### 2 channels relay

2 outputs 16A each, total device maximum capacity of 25 A.



### Wide range of voltage support

Shelly Pro 2PM can be powered by 110-240 VAC



### Power metering with data storage

Two integrated precise power meters that allow you to measure the consumption for each channel separately



### Two-directional control

Control any 110-240 VAC bi-directional motor, roller shutters, motorized curtains, or awning



### Wide variety of appliances control

Suitable for appliances, roller shutters, awnings, motors up to 600 W, lights on different phases, and many more.



### Enhanced safety

Flame retardant shell (V-0) with internal overtemperature, over-power and overvoltage protection.



### Enhanced security

MQTT and WSS support, TLS and custom certificates support for a broad range of use cases.



### No hub required

Control directly and without a hub through your smartphone with Shelly Cloud App.



### Highly compatible

Use with your preferred home automation platforms and voice assistants.

## BLINDERS AND ROLLER SHUTTERS AUTOMATION WITH PRECISE POWER METERING

Shelly Pro 2PM is a 2 channel relay, supporting up to 16 A per phase with total device capacity of 25 A. Equipped with two integrated precise power meters that allow customers to measure the consumption for each channel separately. Shelly Pro 2PM is suitable for appliances, roller shutters, awnings, motors up to 600 W. Power it with 110-240 VAC, use scripting functionalities to set custom automation scenes based on various occurrences.

## TECHNICAL SPECIFICATIONS

<b>Power supply</b>	110-240 VAC, 50/60 Hz
<b>Max load per channel</b>	16 A
<b>Total max. current of all outputs</b>	25 A
<b>Complies with EU standards:</b>	<ul style="list-style-type: none"> <li>• RE Directive 2014/53/EU</li> <li>• LVD 2014/35/EU</li> <li>• EMC 2014/30/EU</li> <li>• RoHS2 2011/65/EU</li> </ul>
<b>Working temperature</b>	-20°C to 40°C
<b>Max RF output power</b>	13.34 dBm
<b>Wireless/Wi-Fi Protocol</b>	802.11 b/g/n (2.4 GHz)
<b>Frequency:</b>	2412 - 2472 MHz
<b>Operational range (depending on local conditions)</b>	<ul style="list-style-type: none"> <li>• up to 50 m outdoors</li> <li>• up to 30 m indoors</li> </ul>
<b>Dimensions (HxWxD)</b>	94x19x69 mm
<b>Electrical consumption</b>	< 3 W
<b>Wire cross section range</b>	0.5 - 1.5 mm <sup>2</sup> (blue) 0.5 - 2.5 mm <sup>2</sup> (green)

## HOW TO CONNECT

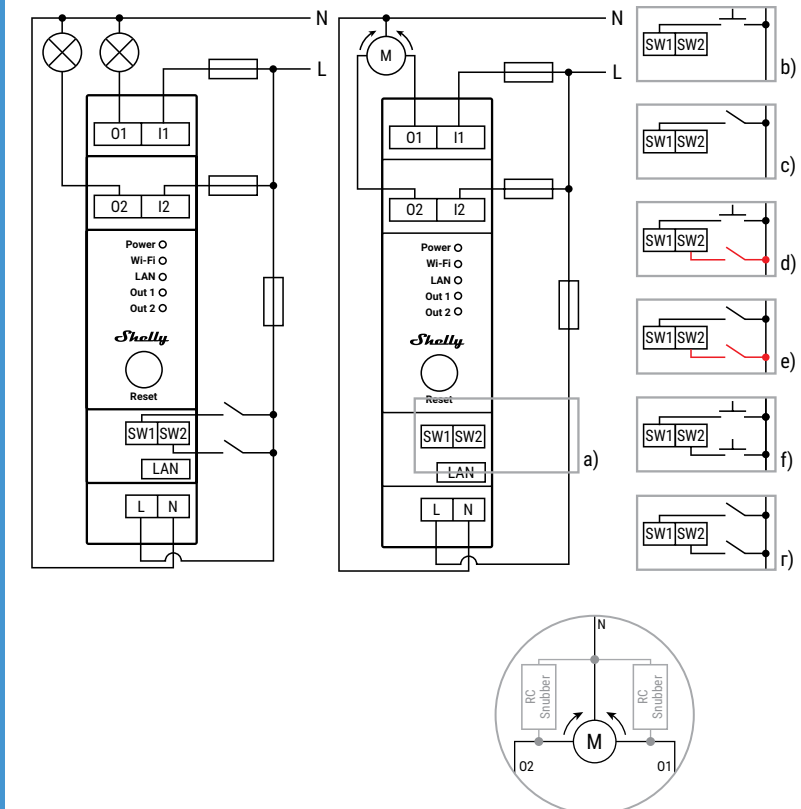

### Legend

#### Device terminals:

- O1, O2:** Load output terminals
- I1, I2:** Load input terminals
- SW1, SW2:** Switch input terminals controlling O1 and O2
- L:** Live (110-240 VAC) terminal
- N:** Neutral terminal
- LAN:** Local Area Network RJ 45 connector

#### Cables:

- N:** Neutral cable
- L:** Live (110-240 VAC) cable

# Shelly PRO 4PM



## SUPREME HOME AND FACILITY AUTOMATION STRAIGHT FROM THE BREAKER BOX

4-channel DIN-mountable smart relay with Wi-Fi, Bluetooth and LAN connectivity. **Shelly Pro 4PM** is enhanced with temperature, overpower, and overvoltage load protection. It allows full automation for residential, commercial, and other applications.

### USE SHELLY PRO 4PM FOR

With the power to control and power measure a variety of appliances, Shelly Pro 4PM can work standalone or be complementary to any existing automation project in your home or office.

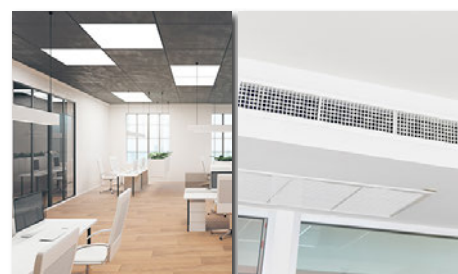

Office lights    Ventilation control



Office outlets    Heating system



AC motor pumps control    Load shedding control



#### LAN connection

Enhanced with LAN connection for even more stable connection.



#### Wi-Fi operated

Connect Shelly Pro 4PM to your Wi-Fi network.



#### Bluetooth connectivity

Add devices quickly and easily via Bluetooth connection, using Shelly Cloud App.

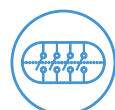

#### 4 channels

4 outputs, 16A each, total device maximum of 40 A.



#### Screen with navigation keys

1.8-inch color screen for quick relay control and settings update.



#### Power metering with data storage

Four integrated precise power meters that allow you to measure the consumption for each channel separately.



#### Wide variety of appliances control

Suitable for controlling and measuring the consumption of lights, appliances, pool system heaters, and many more.



#### Enhanced safety

Flame retardant shell (V-0) with internal overtemperature, over-power and overvoltage protection.



#### Enhanced security

MQTT and WSS support, TLS certificate support and management for a broad range of use cases.



#### No hub required

Control directly without a hub through your smartphone with Shelly Cloud App.



#### Highly compatible

Use with your preferred home automation platforms and voice assistants.

### TECHNICAL SPECIFICATIONS

<b>Power supply</b>	110-240 VAC, 50/60 Hz
<b>Max load per channel</b>	16 A
<b>Total max. current of all outputs</b>	40 A
<b>Complies with EU standards:</b>	<ul style="list-style-type: none"> <li>• RE Directive 2014/53/EU</li> <li>• LVD 2014/35/EU</li> <li>• EMC 2014/30/EU</li> <li>• RoHS2 2011/65/EU</li> </ul>
<b>Working temperature</b>	0°C to 40°C
<b>Max RF output power</b>	13.83 dBm
<b>Wireless/Wi-Fi Protocol</b>	802.11 b/g/n (2.4 GHz)
<b>Frequency:</b>	2412 - 2472 MHz
<b>Operational range (depending on local conditions)</b>	<ul style="list-style-type: none"> <li>• up to 50 m outdoors</li> <li>• up to 30 m indoors</li> </ul>
<b>Dimensions (HxWxD)</b>	95x53x58 mm
<b>Electrical consumption</b>	< 4 W

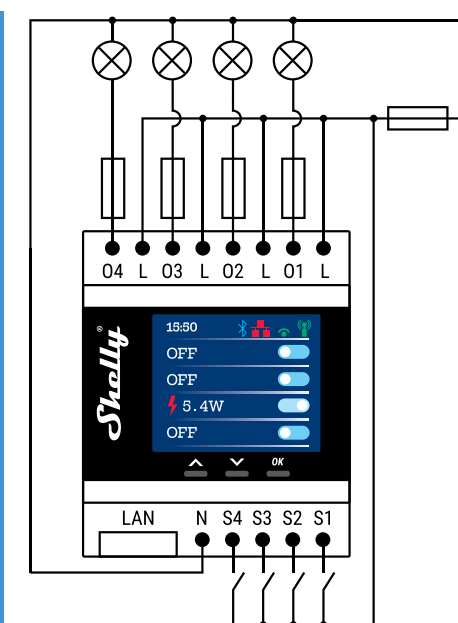

#### Legend

N - Neutral input / cable (Zero);  
L - Live input / cable (110-240 VAC);  
L\* - Input of O1, O2, O3, O4;  
O1, O2, O3, O4 - Output 1, 2, 3, 4;  
S1, S2, S3, S4 - Switch inputs controlling O1, O2, O3, O4  
LAN - Local Area Network RJ 45 connector  
\*The cables connected to L must be with the same length!





# Shelly PRO 3



## USE SHELLY PRO 3 FOR:

You can use Shelly pro 3 to set different types of actions, scenes, and schedules and sync your environment to your daily activities or business needs. Additionally, Shelly Pro 3 has scripting functionalities for custom automation scenes based on external data or various occurrences.

## COMMON AREA TEMPERATURE CONTROL



## COMMON SPACES LIGHTS AUTOMATION



### LAN, Wi-Fi and Bluetooth:

Simultaneous Wi-Fi and LAN usage, add device fast and easy via Bluetooth connection

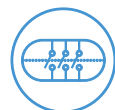

### 3 channel:

Up to 16 A per channel with up to 48 A total device maximum.



### Dry Contacts:

Use a wide range of output voltage levels. Supports low voltages.



### Wide range of voltage support:

Use it to control a wide range of AC devices and appliances.



### Extremely fast processor

For immediate command execution and notification.



### Wide variety of appliances control

Suitable for automating the lights, irrigation system, heaters, and many more.



### Enhanced safety

Flame retardant shell (V-0) with internal overtemperature, over-power and overvoltage protection.



### Enhanced security

MQTT and WSS support, TLS and custom certificates support for a broad range of use cases.



### No hub required

Control directly and without a hub through your smartphone with Shelly Cloud App.



### Highly compatible

Use with your preferred home automation platforms and voice assistants

## PROFESSIONAL 3-CHANNEL DIN RAIL RELAY WITH DRY CONTACTS

Shelly Pro 3 is a three-phase, 3-channel relay supporting up to 48 A for professional lights and appliance automation for residential or commercial use. It is equipped with potential-free outputs (dry contacts) offering high flexibility in voltage support and applications.

## TECHNICAL SPECIFICATIONS

<b>Power supply</b>	110-240 VAC, 50/60 Hz
<b>Max load per channel</b>	16 A
<b>Total max. current of all outputs</b>	48 A
<b>Complies with EU standards:</b>	<ul style="list-style-type: none"> <li>• RE Directive 2014/53/EU</li> <li>• LVD 2014/35/EU</li> <li>• EMC 2014/30/EU</li> <li>• RoHS2 2011/65/EU</li> </ul>
<b>Working temperature</b>	-20°C to 40°C
<b>Max RF output power</b>	15.93 dBm
<b>Wireless/Wi-Fi Protocol</b>	802.11 b/g/n (2.4 GHz)
<b>Frequency:</b>	2412 - 2472 MHz
<b>Operational range (depending on local conditions)</b>	<ul style="list-style-type: none"> <li>• up to 50 m outdoors</li> <li>• up to 30 m indoors</li> </ul>
<b>Dimensions (HxWxD)</b>	96x53x59 mm
<b>Electrical consumption</b>	< 3 W

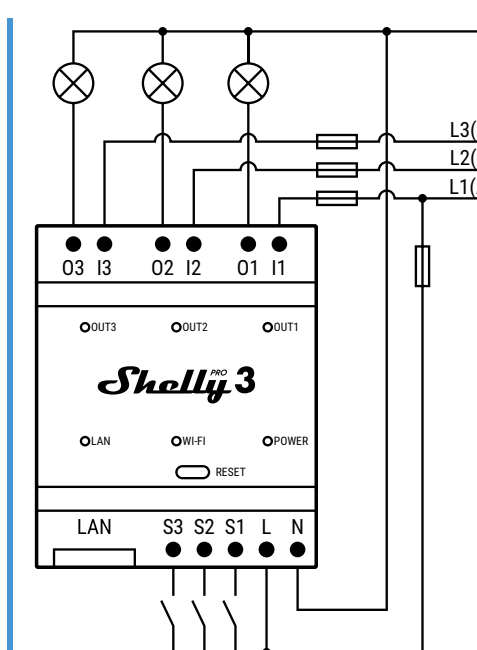

### Legend

#### Device terminals:

- O1, O2, O3: Load output terminals
- I1, I2, I3: Load input terminals
- SW1, SW2, SW3: Switch input terminals controlling O1, O2 and O3
- L: Live (110-240 VAC) terminals
- N: Neutral terminal
- LAN: Local Area Network RJ 45 connector
- Cables:
- N: Neutral cable
- L1(A): Load circuit 1 live (110-240 VAC) cable
- L2(B): Load circuit 2 live (110-240 VAC) cable
- L3(C): Load circuit 3 live (110-240 VAC) cable

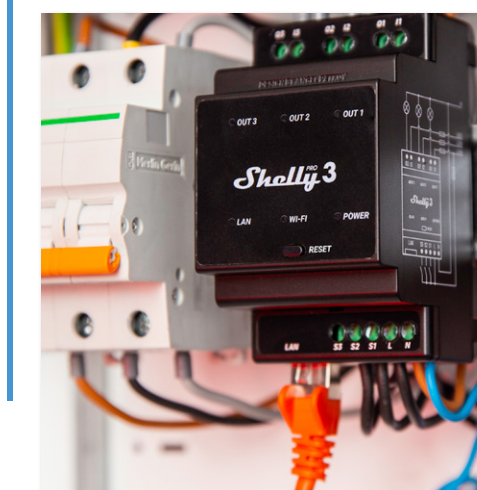

# Shelly<sup>PRO</sup> 3EM



## INDUSTRY-GRADE SECURITY

Shelly Pro 3EM supports mTLS for MQTT, HTTP, and secure outbound WebSockets, allowing for direct connections to your cloud infrastructure, reducing the cost of deploying complex networks and VPNs.



## INDUSTRIAL INSTALLATIONS

Shelly Pro 3EM brings support for MODBUS for voltage, current, power, and energies. You can accurately sample your energy usage and instantaneous values of voltage, current, and power.



## SOLAR PANELS MONITORING AND CONTROL

Save effortlessly by keeping track of how much energy your solar panels or wind turbines are generating. With Shelly Pro 3EM you can get real-time information about the efficiency of the solar and wind energy system.



### Wi-Fi, LAN, and Bluetooth connectivity

Simultaneous Wi-Fi and LAN usage, add device fast and easily via Bluetooth connection

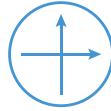

### 4-quadrant measurement

Measure capacitive and inductive load types of active imported and exported energies.



### Accuracy class B (active energy)

Shelly Pro 3EM has a measurement accuracy of 1%.



### MODBUS support

Allows for easy and fast deployment in existing industrial installations.



### Power monitoring

Monitors mono-phase electrical systems with up to 3 points simultaneously. Fast notifications and at least 60 days of 1-minute records storage.



### Scripting functionalities

Shelly Pro 3EM fully supports mJS scripting, allowing you to create further features and functionalities.



### Enhanced safety

Flame retardant shell (V-0) with internal overtemperature, over-power and overvoltage protection.



### Enhanced security

MQTT and WSS support, TLS and custom certificates support for a broad range of use cases.



### No hub required

Control directly and without a hub through your smartphone with Shelly Cloud App.



### Highly compatible

Use with your preferred home automation platforms and voice assistants

## NEXT-GENERATION DIN-MOUNTABLE 3-PHASE ENERGY METER

Shelly Pro 3EM is a DIN rail mountable three-phase energy meter. Enhanced with all the Gen 2 firmware flexibility and LAN connectivity, it provides professional integrators with additional options for end-customer solutions. Shelly Pro 3EM reports accumulated energy as well as instantaneous voltage, current, and power factor per phase in real time.

### TECHNICAL SPECIFICATIONS

<b>Power supply</b>	110-240 VAC, 50/60 Hz
<b>Voltmeters (RMS for each phase)</b>	100 - 260 V
<b>Voltmeters accuracy</b>	±1 %
<b>Ammeters (RMS via CT for each phase and the Neutral):</b>	0 - 120 A
<b>Complies with EU standards:</b>	<ul style="list-style-type: none"> <li>RE Directive 2014/53/EU</li> <li>LVD 2014/35/EU</li> <li>EMC 2014/30/EU</li> <li>RoHS2 2011/65/EU</li> </ul>
<b>Working temperature</b>	-20°C to 40°C
<b>Max RF output power Wi-Fi</b>	15 dBm
<b>Wireless/Wi-Fi Protocol</b>	802.11 b/g/n (2.4 GHz)
<b>Frequency:</b>	2412 - 2472 MHz
<b>Operational range (depending on local conditions)</b>	<ul style="list-style-type: none"> <li>up to 50 m outdoors</li> <li>up to 30 m indoors</li> </ul>
<b>Dimensions (HxWxD)</b>	94x19x69 mm

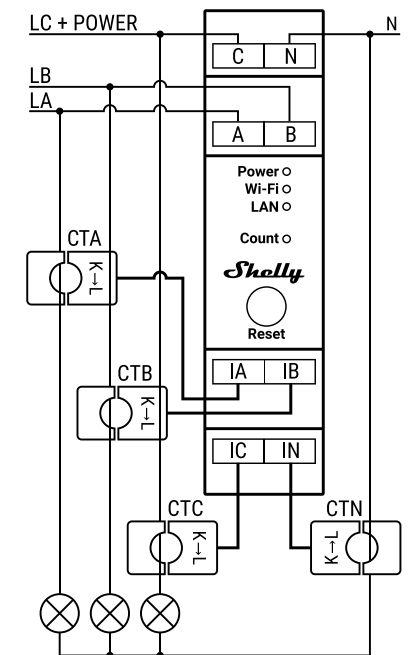

### Legend

#### Device terminals:

- A: Phase A input
- B: Phase B input
- C: Phase C and Device power supply input
- N: Neutral input
- IA: Phase A current transformer (CTA) input
- IB: Phase B current transformer (CTB) input
- IC: Phase C current transformer (CTC) input
- IN: Neutral current transformer (CTN) input

#### Cables:

- LA: Phase A (110-240 VAC)
- LB: Phase B (110-240 VAC)
- LC: Phase C (110-240 VAC)
- N: Neutral cable

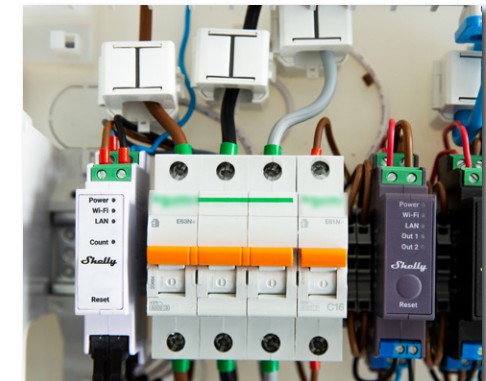



# ACCESSORIES FOR SHELLY PRODUCTS

With these accessories you can improve your experience with Shelly products.

## Shelly Button

Safe way to use Shelly 1, Shelly 1PM and Shelly Dimmer out of the wall. You can make any table light, fan or heater smart.



## Shelly H&T power adapter

You can power your Shelly H&T with USB instead of battery.



## Outdoor IP55 AddOn - UK

## Split core current transformer

Used together with Shelly EM or Shelly 3EM for energy metering.

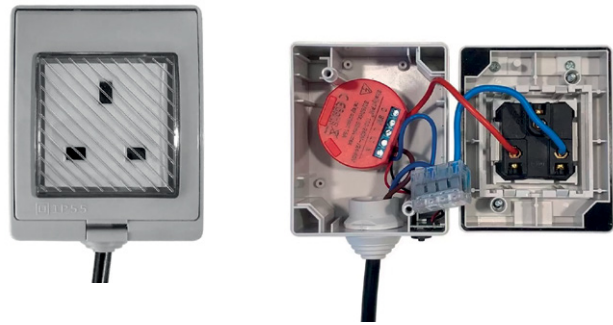

## Shelly GAS addon manipulator Shelly Plus Add-On

Add-on for Shelly Plus devices. Can be used with up to five DS18B20 sensors or one DHT22 sensor.



## Bypass



# WALL SWITCH FOR SMART RELAYS

Designed to facilitate your specific automation needs and developed with the smallest details in mind, you can now create a custom wall switch for your Shelly relays, and save on space and money!

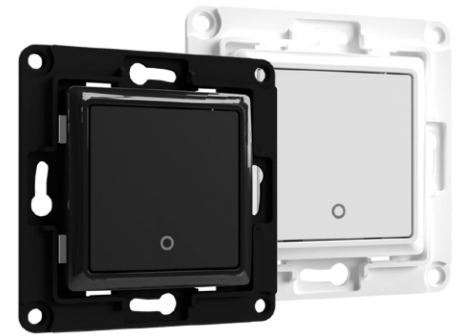

### FITS INTO THE TINIEST SPACES!

Compact dimensions and simple wiring that can fit into any existing switch console or even the tiniest spaces.

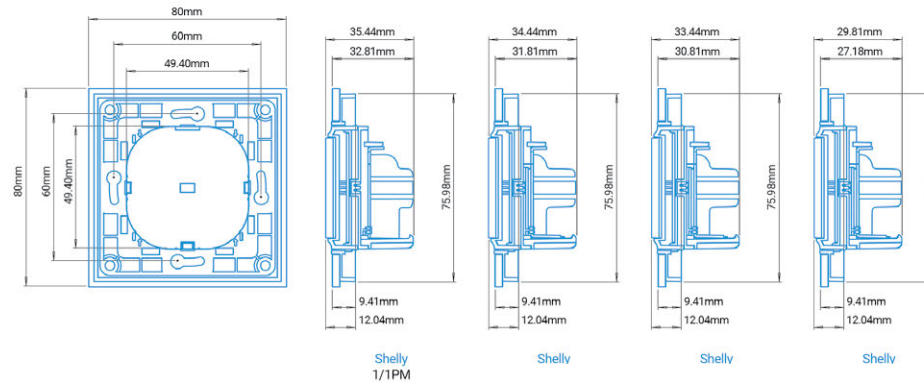

### HIGHLY CUSTOMIZABLE!

Each Shelly Wall Switch for Smart Relays comes with corresponding relay holders. You can choose the relay holder that you need to fulfill your automation project.

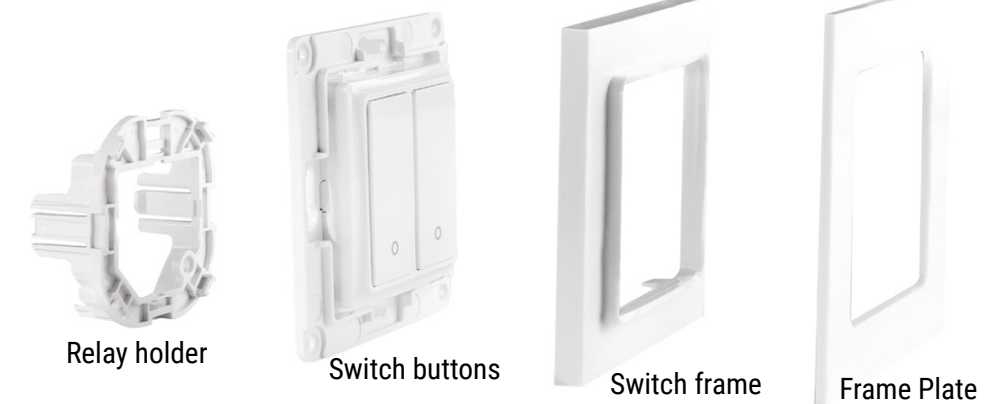

### AVAILABLE SWITCHES\*:

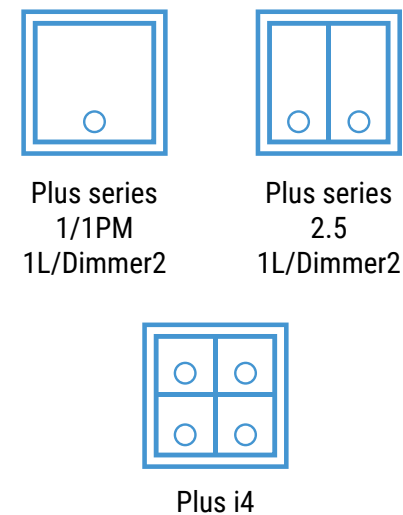

### AVAILABLE FRAMES\*:

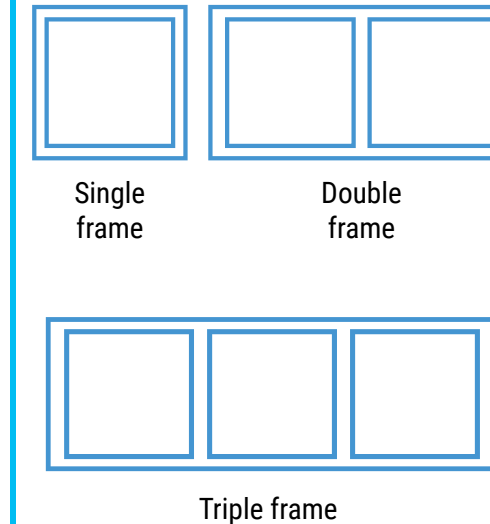

### AVAILABLE COLORS:

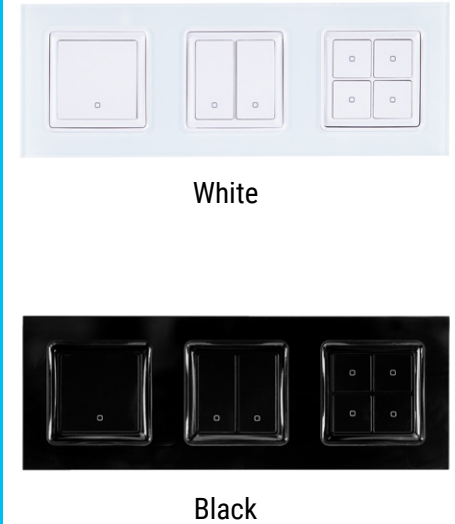

\*Shelly Wall switches and Shelly Wall frames are sold separately!







# ALLTERCO